



ROHDE & SCHWARZ

Test and Measurement
Division

Operating Manual

EMI TEST RECEIVER 150 (9) kHz to 1000 (2500) MHz

ESPC

1082.8007.10

Printed in the Federal
Republic of Germany



Qualitätszertifikat

Sehr geehrter Kunde,

Sie haben sich für den Kauf eines Rohde & Schwarz-Produktes entschieden. Hiermit erhalten Sie ein nach modernsten Fertigungsmethoden hergestelltes Produkt. Es wurde nach den Regeln unseres Qualitätsmanagementsystems entwickelt, gefertigt und geprüft. Das Rohde & Schwarz-Qualitätsmanagementsystem ist u.a. nach ISO 9001 und ISO 14001 zertifiziert.

Certificate of quality

Dear Customer,

You have decided to buy a Rohde & Schwarz product. You are thus assured of receiving a product that is manufactured using the most modern methods available. This product was developed, manufactured and tested in compliance with our quality management system standards. The Rohde & Schwarz quality management system is certified according to standards such as ISO 9001 and ISO 14001.

Certificat de qualité

Cher client,

Vous avez choisi d'acheter un produit Rohde & Schwarz. Vous disposez donc d'un produit fabriqué d'après les méthodes les plus avancées. Le développement, la fabrication et les tests respectent nos normes de gestion qualité. Le système de gestion qualité de Rohde & Schwarz a été homologué, entre autres, conformément aux normes ISO 9001 et ISO 14001.



ROHDE & SCHWARZ

Customer Support

Technical support – where and when you need it

For quick, expert help with any Rohde & Schwarz equipment, contact one of our Customer Support Centers. A team of highly qualified engineers provides telephone support and will work with you to find a solution to your query on any aspect of the operation, programming or applications of Rohde & Schwarz equipment.

Up-to-date information and upgrades

To keep your Rohde & Schwarz equipment always up-to-date, please subscribe to an electronic newsletter at <http://www.rohde-schwarz.com/www/response.nsf/newsletterpreselection>

or request the desired information and upgrades via email from your Customer Support Center (addresses see below).

Feedback

We want to know if we are meeting your support needs. If you have any comments please email us and let us know CustomerSupport.Feedback@rohde-schwarz.com.

USA & Canada

Monday to Friday (except US-state holidays)
8:00 AM – 8:00 PM Eastern Standard Time (EST)

USA: 888-test-rsa (888-837-8772) (opt 2)
From outside USA: +1 410 910 7800 (opt 2)
Fax: 410 910 7801

E-Mail: Customer.Support@rsa.rohde-schwarz.com

Rest of World

Monday to Friday (except German-state holidays)
08:00 – 17:00 Central European Time (GET)

Europe: +49 (0) 180 512 42 42
From outside Europe: +49 89 4129 13776
Fax: +49 (0) 89 41 29 637 78

E-Mail: CustomerSupport@rohde-schwarz.com



ROHDE & SCHWARZ

Adressen/Addresses

FIRMENSITZ/HEADQUARTERS

	Phone
	Fax
	E-mail
Rohde & Schwarz GmbH & Co. KG	+49 (89) 41 29-0
Mühlendorfstraße 15 · D-81671 München	+49 89 4129-121 64
Postfach 80 14 69 · D-81614 München	info@rohde-schwarz.com

WERKE/PLANTS

Rohde & Schwarz Messgerätebau GmbH	+49 (8331) 108-0
Riedbachstraße 58 · D-87700 Memmingen	+49 (8331) 108-11 24
Postfach 1652 · D-87686 Memmingen	info.rsmb@rohde-schwarz.com

Rohde & Schwarz GmbH & Co. KG	+49 (9923) 857-0
Werk Teisnach	+49 (9923) 857-11 74
Kaikenrieder Straße 27 · D-94244 Teisnach	info.rsts@rohde-schwarz.com
Postfach 1149 · D-94240 Teisnach	

Rohde & Schwarz GmbH & Co. KG	+49 (2203) 49-0
Dienstleistungszentrum Köln	+49 (2203) 49 51-308
Graf-Zepelin-Straße 18 · D-51147 Köln	info.rsdsc@rohde-schwarz.com
Postfach 98 02 60 · D-51130 Köln	service.rsdsc@rohde-schwarz.com

TOCHTERUNTERNEHMEN/SUBSIDIARIES

Rohde & Schwarz Vertriebs-GmbH	+49 (89) 41 29-137 74
Mühlendorfstraße 15 · D-81671 München	+49 (89) 41 29-137 77
Postfach 80 14 69 · D-81614 München	

Rohde & Schwarz International GmbH	+49 (89) 41 29-129 84
Mühlendorfstraße 15 · D-81671 München	+49 (89) 41 29-120 50
Postfach 80 14 60 · D-81614 München	info.rsi@rohde-schwarz.com

Rohde & Schwarz Engineering and Sales GmbH	+49 (89) 41 29-137 11
Mühlendorfstraße 15 · D-81671 München	+49 (89) 41 29-137 23
Postfach 80 14 29 · D-81614 München	info.rse@rohde-schwarz.com

Rohde & Schwarz BICK Mobilfunk GmbH	+49 (5042) 998-0
Fritz-Hahne-Str. 7 · D-31848 Bad Münder	+49 (5042) 998-105
Postfach 2062 · D-31844 Bad Münder	info.bick@rohde-schwarz.com

Rohde & Schwarz FTK GmbH	+49 (30) 658 91-122
Wendenschlossstraße 168, Haus 28	+49 (30) 655 50-221
D-12557 Berlin	info.ftk@rohde-schwarz.com

Rohde & Schwarz SIT GmbH	+49 (30) 658 84-0
Agastraße 3	+49 (30) 658 84-183
D-12489 Berlin	info.sit@rohde-schwarz.com

ADRESSEN WELTWEIT/ADDRESSES WORLDWIDE

Albania	siehe/see Austria	
Algeria	Rohde & Schwarz Bureau d'Alger 5B Place de Laperrine 16035 Hydra-Alger	+213 (21) 48 20 18 +213 (21) 69 46 08
Argentina	Precision Electronica S.R.L. Av. Pde Julio A. Roca 710 - 6° Piso (C1067ABP) Buenos Aires	+541 (14) 331 41 99 +541 (14) 334 51 11 alberto_lombardi@prec-elec.com.ar
Australia	Rohde & Schwarz (Australia) Pty. Ltd. Sales Support Unit 6 2-8 South Street Rydalmere, N.S.W. 2116	+61 (2) 88 45 41 00 +61 (2) 96 38 39 88 lyndell.james@rsaus.rohde-schwarz.com
Austria	Rohde & Schwarz-Österreich Ges.m.b.H. Am Europlatz 3 Gebäude B 1120 Wien	+43 (1) 602 61 41-0 +43 (1) 602 61 41-14 rs-austria@roe.rohde-schwarz.com
Azerbaijan	Rohde & Schwarz Azerbaijan Liaison Office Baku ISR Plaza 340 Nizami Str. 370000 Baku	+994 (12) 93 31 38 +994 (12) 93 03 14 rs-azerbaijan@rus.rohde-schwarz.com

Baltic Countries siehe/see Denmark

Bangladesh	BIL Consortium Ltd. Corporate Office House-33, Road-4, Block-F Banani Dhaka-1213	+880 (2) 881 06 53 +880 (2) 882 82 91
-------------------	--	--

Belgium	Rohde & Schwarz Belgium N.V. Excelsiorlaan 31 Bus 1 1930 Zaventem	+32 (2) 721 50 02 +32 (2) 725 09 36 info@rsb.rohde-schwarz.com
----------------	---	--

Bosnia-Herzegovina siehe/see Slovenia

Brazil	Rohde & Schwarz Do Brasil Ltda. Av. Alfredo Egidio de Souza Aranha n° 177, 1° andar - Santo Amaro 04726-170 Sao Paulo - SP	+55 (11) 56 44 86 11 (general) +55 (11) 56 44 86 25 (sales) +55 (11) 56 44 86 36 sales-brazil@rsb.rohde-schwarz.com
---------------	---	--

Brunei	GKL Equipment Pte Ltd. #11-01 BP Tower 396 Alexandra Road Singapore 119954	+65 (6) 276 06 26 +65 (6) 276 06 29 gkleqpt@singnet.com.sg
---------------	---	--

Bulgaria	Rohde & Schwarz Representation Office Bulgaria 39, Fridtjof Nansen Blvd. 1000 Sofia	+359 (2) 96 343 34 +359 (2) 96 321 97 rs-bulgaria@rsbg.rohde-schwarz
-----------------	--	--

Canada	Rohde & Schwarz Canada Inc. 555 March Rd. Kanata, Ontario K2K 2M5	+1 (613) 592 80 00 +1 (613) 592 80 09 cgjrwarnauth@rscanada.ca
---------------	---	--

	Tektronix Canada Inc. Test and Measurement 4929 Place Olivia Saint-Laurent, Pq Montreal H4R 2V6	+1 (514) 331 43 34 +1 (514) 331 59 91
--	---	--

Chile	Dymeq Ltda. Av. Larrain 6666 Santiago	+56 (2) 339 20 00 +56 (2) 339 20 10 dymeq@dymeq.com
--------------	---	---

China	Rohde & Schwarz China Ltd. Representative Office Beijing Room 602, Parkview Center 2 Jiangtai Road Chao Yang District Beijing 100016	+86 (10) 64 31 28 28 +86 (10) 64 37 98 88 info.rschina@rsbp.rohde-schwarz.com
--------------	---	---

	Rohde & Schwarz China Ltd. Representative Office Shanghai Central Plaza 227 Huangpi North Road RM 807/809 Shanghai 200003	+86 (21) 63 75 00 18 +86 (21) 63 75 91 70
--	--	--

	Rohde & Schwarz China Ltd. Representative Office Guangzhou Room 2903, Metro Plaza 183 Tianhe North Road Guangzhou 510075	+86 (20) 87 55 47 58 +86 (20) 87 55 47 59
--	--	--

	Rohde & Schwarz China Ltd. Representative Office Chengdu Unit G, 28/F, First City Plaza 308 Shuncheng Avenue Chengdu 610017	+86 (28) 86 52 76 05 to 09 +86 (28) 86 52 76 10 rsbpc@mail.sc.cninfo.net
--	---	--

	Rohde & Schwarz China Ltd. Representative Office Xi'an Room 10125, Jianguo Hotel Xi'an No. 2, Huzhu Road Xi'an 710048	+86 (29) 321 82 33 +86 (29) 329 60 15 sherry.yu@rsbp.rohde-schwarz.com
--	---	--

Adressen/Addresses

China	Rohde & Schwarz China Ltd. Representative Office Shenzhen No. 2002 Jiabin Road Luohu District Shenzhen 518001	+86 (755) 25 18 50 18 +86 (755) 25 18 50 18 jessica.lia@rsbp.rohde-schwarz.com	Germany	Zweigniederlassung Büro Bonn Josef-Wirmer-Straße 1-3 · D-53123 Bonn Postfach 140264 · D-53057 Bonn	+49 (228) 918 90-0 +49 (228) 25 50 87 info.rsv@rohde-schwarz.com	
Croatia	siehe/see Slovenia			Zweigniederlassung Nord, Geschäftsstelle Hamburg Steilshooper Alle 47 · D-22309 Hamburg Postfach 60 22 40 · D-22232 Hamburg	+49 (40) 63 29 00-0 +49 (40) 630 78 70 info.rsv@rohde-schwarz.com	
Cyprus	Hinis Telecast Ltd. Agiou Thoma 18 Kiti Larnaca 7550	+357 (24) 42 51 78 +357 (24) 42 46 21 hinis@logos.cy.net		Zweigniederlassung Mitte, Geschäftsstelle Köln Niederkasseler Straße 33 · D-51147 Köln Postfach 900 149 · D-51111 Köln	+49 (2203) 807-0 +49 (2203) 807-650 info.rsv@rohde-schwarz.com	
Czech Republic	Rohde & Schwarz Praha s.r.o. Hadovka Office Park Evropská 33c 16000 Praha 6	+420 (2) 24 31 12 32 +420 (2) 24 31 70 43 office@rscz.rohde-schwarz.com		Zweigniederlassung Süd, Geschäftsstelle München Mühlendorfstraße 15 · D-81671 München Postfach 80 14 69 · D-81614 München	+49 (89) 41 86 95-0 +49 (89) 40 47 64 info.rsv@rohde-schwarz.com	
Denmark	Rohde & Schwarz Danmark A/S Ejby Industrivej 40 2600 Glostrup	+45 (43) 43 66 99 +45 (43) 43 77 44		Zweigniederlassung Süd, Geschäftsstelle Nürnberg Donaustraße 36 D-90451 Nürnberg	+49 (911) 642 03-0 +49 (911) 642 03-33 info.rsv@rohde-schwarz.com	
Ecuador	Representaciones Manfred Weinzierl Via Láctea No. 4 y Via Sta. Inés P.O.Box 17-22-20309 1722 Cumbayá-Quito	+593 (22) 89 65 97 +593 (22) 89 65 97 mweinzierl@plus.net.ec		Zweigniederlassung Mitte, Geschäftsstelle Neu-Isenburg Siemensstraße 20 D-63263 Neu-Isenburg	+49 (6102) 20 07-0 +49 (6102) 20 07 12 info.rsv@rohde-schwarz.com	
Egypt	U.A.S. Universal Advanced Systems 31 Manshiet El-Bakry Street Heliopolis 11341 Cairo	+20 (2) 455 67 44 +20 (2) 256 17 40 an_uas@link.net		Ghana	Kop Engineering Ltd. P.O. Box 11012 3rd Floor Akai House, Osu Accra North	+233 (21) 77 89 13 +233 (21) 701 06 20
El Salvador	siehe/see Mexico			Greece	Mercury S.A. 6, Loukianou Str. 10675 Athens	+302 (10) 722 92 13 +302 (10) 721 51 98 mercury@hol.gr
Estonia	Rohde & Schwarz Danmark A/S Estonian Branch Office Narva mnt. 13 10151 Tallinn	+372 (6) 14 31 23 +372 (6) 14 31 21 margo.fingling@rsdk.rohde-schwarz.com		Guatemala	siehe/see Mexico	
Finland	Orbis Oy P.O.Box 15 00421 Helsinki 42	+358 (9) 47 88 30 +358 (9) 53 16 04 info@orbis.fi		Honduras	siehe/see Mexico	
France	Rohde & Schwarz France Immeuble "Le Newton" 9-11, rue Jeanne Braconnier 92366 Meudon La Forêt Cédex	+33 (1) 41 36 10 00 +33 (1) 41 36 11 73 contact@rsf.rohde-schwarz.com		Hong Kong	Electronic Scientific Engineering 9/F North Somerset House Taikoo Place 979 King's Road Hong Kong	+852 (25) 07 03 33 +852 (25) 07 09 25 stephenchau@ese.com.hk
	Niederlassung/Subsidiary Rennes 37 Rue du Bignon Bât. A F-35510 Cesson Sevigne	+33 (0) 299 51 97 00 +33 (0) 299 51 98 77		Hungary	Rohde & Schwarz Budapesti Iroda Váci út 169 1138 Budapest	+36 (1) 412 44 60 +36 (1) 412 44 61 rs-hungary@rshu.rohde-schwarz.com
	Niederlassung/Subsidiary Toulouse Technoparc 3 B.P. 501 F-31674 Labège Cédex	+33 (0) 561 39 10 69 +33 (0) 561 39 99 10		Iceland	siehe/see Denmark	
	Office Aix-en-Provence	+33 (0) 494 07 39 94 +33 (0) 494 07 55 11		India	Rohde & Schwarz India Pvt. Ltd. Bangalore Office No. 24, Service Road, Domlur 2nd Stage Extension Bangalore - 560 071	+91 (80) 535 23 62 +91 (80) 535 03 61 rsindiab@rsnl.net
	Office Lyon	+33 (0) 478 29 88 10 +33 (0) 478 79 18 57		India	Rohde & Schwarz India Pvt. Ltd. Hyderabad Office 302 & 303, Millenium Centre 6-3-1099/1100, Somajiguda Hyderabad - 500 016	+91 (40) 23 32 24 16 +91 (40) 23 32 27 32 rsindiah@nd2.dot.net.in
	Office Nancy	+33 (0) 383 54 51 29 +33 (0) 383 54 82 09		India	Rohde & Schwarz India Pvt. Ltd. RS India Mumbai Office B-603, Remi Bizcourt, Shah Industrial Estate, Off Veera Desai Road Mumbai - 400 058	+91 (22) 26 30 18 10 +91 (22) 26 73 20 81 rsindiam@rsnl.net
Germany	Zweigniederlassungen der Rohde & Schwarz Vertriebs-GmbH/Branch offices of Rohde & Schwarz Vertriebs-GmbH			Indonesia	PT Rohde & Schwarz Indonesia Graha Paramita 5th Floor Jln. Denpasar Raya Blok D-2 Jakarta 12940	+62 (21) 252 36 08 +62 (21) 252 36 07 sales@rsbj.rohde-schwarz.com services@rsbj.rohde-schwarz.com
	Zweigniederlassung Nord, Geschäftsstelle Berlin Ernst-Reuter-Platz 10 · D-10587 Berlin Postfach 100620 · D-10566 Berlin	+49 (30) 34 79 48-0 +49 (30) 34 79 48 48 info.rsv@rohde-schwarz.com				

Adressen/Addresses

Iran	Rohde & Schwarz Iran Groundfloor No. 1, 14th Street Khaled Eslamboli (Vozara) Ave. 15117 Tehran	+98 (21) 872 42 96 +98 (21) 871 90 12 rs-tehran@neda.net	Lebanon	Netcom P.O.Box 55199 Op. Ex-Presidential Palace Horsh Tabet Beirut	+961-1-48 69 99 +961-1-49 05 11 netcom@inco.com.lb
Ireland	siehe/see United Kingdom		Liechtenstein	siehe/see Switzerland	
Israel	Eastronics Ltd. Messtechnik/T&M Equipment 11 Rozanis St. P.O.Box 39300 Tel Aviv 61392	+972 (3) 645 87 77 +972 (3) 645 86 66 david_hasky@easx.co.il	Lithuania	Rohde & Schwarz Danmark A/S Lithuanian Office Lukiskiu 5-228 2600 Vilnius	+370 (5) 239 50 10 +370 (5) 239 50 11
	J.M. Moss (Engineering) Ltd. Kommunikationstechnik/ Communications Equipment 9 Oded Street P.O.Box 967 52109 Ramat Gan	+972 (3) 631 20 57 +972 (3) 631 40 58 jmmoss@zahav.net.il	Luxembourg	siehe/see Belgium	
Italy	Rohde & Schwarz Italia S.p.a. Centro Direzionale Lombardo Via Roma 108 20060 Cassina de Pecchi (MI)	+39 (02) 95 70 42 03 +39 (02) 95 30 27 72 ornella.crippa@rsi.rohde-schwarz.com	Macedonia	siehe/see Slovenia	
	Rohde & Schwarz Italia S.p.a. Via Tiburtina 1182 00156 Roma	+39 (06) 41 59 82 18 +39 (06) 41 59 82 70	Malaysia	Dagang Teknik Sdn. Bhd. No. 9, Jalan SS 4D/2 Selangor Darul Ehsan 47301 Petaling Jaya	+60 (3) 27 03 55 68 +60 (3) 27 03 34 39 maryanne@danik.com.my
Japan	Rohde & Schwarz Support Center Japan K.K. 711 bldg., Room 501 (5th floor) 7-11-18 Nishi-Shinjuku Shinjuku-ku Tokyo 160-0023	+81 (3) 59 25 12 88 +81 (3) 59 25 12 90	Malta	ITEC International Technology Ltd B'Kara Road San Gwann SGN 08	+356 (21) 37 43 00 or 37 43 29 +356 (21) 37 43 53 sales@itec.com.mt
	Advantest Corp. Sales Promotion Department Shinjuku-NS bldg. 2-4-1, Nishi-Shinjuku Shinjuku-ku Tokyo 160-0880	+81 (3) 33 42 75 52 +81 (3) 53 22 72 70 mkoyama@ns.advantest.co.jp	Mexico	Rohde & Schwarz de Mexico Av. Prof. Americas No. 1600, 2° Piso Col. Country Club Guadalajara, Jal. Mexico CP, 44610	+52 (33) 36 78 91 70 +52 (33) 36 78 92 00
Jordan	Jordan Crown Engineering & Trading Co. Jabal Amman, Second Circle Youssef Ezzideen Street P.O.Box 830414 Amman, 11183	+962 (6) 462 17 29 +962 (6) 465 96 72 jocrown@go.com.jo		Rohde & Schwarz de Mexico S. de R.L. de C.V. German Centre Oficina 4-2-2 Av. Santa Fé 170 Col. Lomas de Santa Fé 01210 Mexico D.F.	+52 (55) 85 03 99 13 +52 (55) 85 03 99 16 latinoamerica@rsd.rohde-schwarz.com
Kazakhstan	Rohde & Schwarz Kazakhstan Representative Office Almaty Pl. Respubliki 15 480013 Almaty	+7 (32) 72 67 23 54 +7 (32) 72 67 23 46 rs-kazakhstan@rus-rohde-schwarz.com	Moldavia	siehe/see Romania	
Kenya	Excel Enterprises Ltd Dunga Road P.O.Box 42 788 Nairobi	+254 (2) 55 80 88 +254 (2) 54 46 79	Nepal	ICTC Pvt. Ltd. Hattisar, Post Box No. 660 Kathmandu	+977 (1) 443 48 95 +977 (1) 443 49 37 ictc@mos.com.np
Korea	Rohde & Schwarz Korea Ltd. 83-29 Nonhyun-Dong, Kangnam-Ku Seoul 135-010	+82 (2) 3485 1900 +82 (2) 3485 1900 sales@rskor.rohde-schwarz.com service@rskor.rohde-schwarz.com	Netherlands	Rohde & Schwarz Nederland B.V. Perkinsbaan 1 3439 ND Nieuwegein	+31 (30) 600 17 00 +31 (30) 600 17 99 info@rsn.rohde-schwarz.com
Kuwait	Group Five Trading & Contracting Co. Mezzanine Floor Al-Bana Towers Ahmad Al Jaber Street Sharq	+965 (244) 91 72/73/74 +965 (244) 95 28 jk_agarwal@yahoo.com	New Zealand	Nichecom 1 Lincoln Ave. Tawa, Wellington	+64 (4) 232 32 33 +64 (4) 232 32 30 rob@nichecom.co.nz
Latvia	Rohde & Schwarz Danmark A/S Latvian Branch Office Merkela iela 21-301 1050 Riga	+371 (7) 50 23 55 +371 (7) 50 23 60 rsdk@rsdk.rohde-schwarz.com	Nicaragua	siehe/see Mexico	
Lebanon	Rohde & Schwarz Liaison Office Riyadh P.O.Box 361 Riyadh 11411	+966 (1) 465 64 28 Ext. 303 +966 (1) 465 64 28 Ext. 229 chris.porzky@rsd.rohde-schwarz.com	Nigeria	Ferrostaal Abuja Plot 3323, Barada Close P.O.Box 8513, Wuse Off Amazon Street Maitama, Abuja	+234 (9) 413 52 51 +234 (9) 413 52 50 fsabuja@rosecom.net
			Norway	Rohde & Schwarz Norge AS Enebakkeveien 302 B 1188 Oslo	+47 (23) 38 66 00 +47 (23) 38 66 01
			Oman	Mustafa Sultan Science & Industry Co.LLC. Test & Measurement Products Way No. 3503 Building No. 241 Postal Code 112 Al Khuwair, Muscat	+968 63 60 00 +968 60 70 66 m-aziz@mustafasultan.com
			Pakistan	Siemens Pakistan 23, West Jinnah Avenue Islamabad	+92 (51) 227 22 00 +92 (51) 227 54 98 reza.bokhary@siemens.com.pk

Adressen/Addresses

Panama	siehe/see Mexico		
Papua New Guinea	siehe/see Australia		
Philippines	Rohde & Schwarz (Philippines) Ltd. PBCom Tower Ayala Ave. cor. Herrera Sts. Makati City	+63 (2) 755 88 70 +63 (2) 755 88 67	
Poland	Rohde & Schwarz SP.z o.o. Przedstawicielstwo w Polsce ul. Stawki 2, Pietro 28 00-193 Warszawa	+48 (22) 860 64 94 +48 (22) 860 64 99 rs-poland@rspl.rohde-schwarz.com	
Portugal	Rohde & Schwarz Portugal, Lda. Alameda Antonio Sergio 7-R/C - Sala A 2795-023 Linda-a-Velha	+351 (21) 415 57 00 +351 (21) 415 57 10 info@rspt.rohde-schwarz.com	
Romania	Rohde & Schwarz Representation Office Bucharest Str. Uranus 98 Sc. 2, Et. 5, Ap. 36 76102 Bucuresti, Sector 5	+40 (21) 410 68 46 +40 (21) 411 20 13 rs-romania@rsro.rohde-schwarz.com	
Russian Federation	Rohde & Schwarz Representative Office Moscow 119180, Yakimanskaya nab., 2 Moscow	+7 (095) 745 88 50 to 53 +7 (095) 745 88 54 rs-russia@rsru.rohde-schwarz.com	
Saudi Arabia	Rohde & Schwarz Liaison Office Riyadh c/o Haji Abdullah Alireza Co. Ltd. P.O.Box 361 Riyadh 11411	+966 (1) 465 64 28 Ext. 303 +966 (1) 465 6428 Ext. 229 chris.porzky@rsd.rohde-schwarz.com	
Saudi Arabia	Gentec Haji Abdullah Alireza & Co. Ltd. P.O.Box 43054 Riyadh	+966 (1) 465 64 28 +966 (1) 465-64 28 akanbar@gentec.com.sa	
Serbia-Montenegro	Representative Office Belgrade Tose Jovanovica 7 11030 Beograd	+381 (11) 305 50 25 +381 (11) 305 50 24	
Singapore	Rohde & Schwarz Regional Headquarters Singapore Pte. Ltd. 1 Kaki Bukit View #05-01/02 Techview Singapore 415 941	+65 (6) 846 1872 +65 (6) 846 1252 rsca@rssg.rohde-schwarz.com	
Slovak Republic	Specialne systémy a software, a.s. Svrčia ul. 841 04 Bratislava	+421 (2) 65 42 24 88 +421 (2) 65 42 07 68 stefan.lozek@special.sk	
Slovenia	Rohde & Schwarz Representation Ljubljana Tbilisjska 89 1000 Ljubljana	+386 (1) 423 46 51 +386 (1) 423 46 11 rs-slovenia@rs.si.rohde-schwarz.com	
South Africa	Protea Data Systems (Pty.) Ltd. Communications and Measurement Division Private Bag X19 Bramley 2018	+27 (11) 719 57 00 +27 (11) 786 58 91 unicm@protea.co.za	
South Africa	Protea Data Systems (Pty.) Ltd. Cape Town Branch Unit G9, Centurion Business Park Bosmandam Road Milnerton Cape Town, 7441	+27 (21) 555 36 32 +27 (21) 555 42 67 unicm@protea.co.za	
Spain	Rohde & Schwarz Espana S.A. Salcedo, 11 28034 Madrid	+34 (91) 334 10 70 +34 (91) 329 05 06 rses@rses.rohde-schwarz.com	
Sri Lanka	Dynatel Communications (PTE) Ltd. 451/A Kandy Road Kelaniya		+94 (1) 90 80 01 +94 (1) 91 04 69 dyna-svc@slt.net.lk
Sudan	SolarMan Co. Ltd. P.O.Box 11 545 North of Fraouq Cementry 6/7/9 Bldg. 16 Karthoum		+249 (11) 47 31 08 +249 (11) 47 31 38 solarman29@hotmail.com
Sweden	Rohde & Schwarz Sverige AB Marketing Div. Flygfältsgatan 15 128 30 Skarpnäck		+46 (8) 605 19 00 +46 (8) 605 19 80 info@rss.se
Switzerland	Roschi Rohde & Schwarz AG Mühlestr. 7 3063 Ittigen		+41 (31) 922 15 22 +41 (31) 921 81 01 sales@roschi.rohde-schwarz.com
Syria	Electro Scientific Office Baghdad Street Dawara Clinical Lab. Bldg P.O.Box 8162 Damascus		+963 (11) 231 59 74 +963 (11) 231 88 75 memo@hamshointl.com
Taiwan	Rohde & Schwarz Taiwan (Pvt.) Ltd. Floor 14, No. 13, Sec. 2, Pei-Tou Road Taipei 112		+886 (2) 28 93 10 88 +886 (2) 28 91 72 60 celine.tu@rstw.rohde-schwarz.com
Tanzania	SSTL Group P.O. Box 7512 Dunga Street Plot 343/345 Dar es Salaam		+255 (22) 276 00 37 +255 (22) 276 02 93 sstl@ud.co.tz
Thailand	Schmidt Electronics (Thailand) Ltd. 63 Government Housing Bank Bldg. Tower II, 19th floor, Rama 9 Rd. Huaykwang, Bangkok Bangkok 10320		+66 (2) 643 13 30 to 39 +66 (2) 643 13 40 kamthoninthuyot@schmidthailand.com
Trinidad & Tobago	siehe/see Mexico		
Tunisia	Teletek 71, Rue Alain Savary Residence Alain Savary (C64) 1003 Tunis		+216 (71) 77 22 88 +216 (71) 77 05 53
Turkey	Rohde & Schwarz International GmbH Liaison Office Istanbul Bagdad Cad. 191/3, Arda Apt. B-Blok 81030 Selamicesme-Istanbul		+90 (216) 385 19 17 +90 (216) 385 19 18 rsturk@superonline.com
Ukraine	Rohde & Schwarz Representative Office Kiev 4, Patris Loumoumba ul 01042 Kiev		+38 (044) 268 60 55 +38 (044) 268 83 64 rsbkiev@public.ua.net
United Arab Emirates	Rohde & Schwarz International GmbH Liaison Office Abu Dhabi P.O. Box 31156 Abu Dhabi		+971 50 62 40 197 +971 (4) 3944 794 michael.rogler@rsd.rohde-schwarz.com
United Arab Emirates	Rohde & Schwarz Bick Mobile Communication P.O.Box 17466 Dubai		+971 (4) 883 71 35 +971 (4) 883 71 36
United Arab Emirates	Rohde & Schwarz Emirates L.L.C. Ahmed Al Nasri Building, Mezzanine Floor, P.O.Box 31156 Off old Airport Road Behind new GEMACO Furniture Abu Dhabi		+971 (2) 631 20 40 +971 (2) 631 30 40 rsuaeami@emirates.net.ae

Adressen/Addresses







United Kingdom	Rohde & Schwarz UK Ltd. Ancells Business Park Fleet Hampshire GU 51 2UZ England	+44 (1252) 81 88 88 (sales) +44 (1252) 81 88 18 (service) +44 (1252) 81 14 47 sales@rsuk.rohde-schwarz.com
Uruguay	Aeromarine S.A. Cerro Largo 1497 11200 Montevideo	+598 (2) 400 39 62 +598 (2) 401 85 97 mjn@aeromarine.com.uy
USA	Rohde & Schwarz, Inc. Broadcast & Comm. Equipment 8661-A Robert Fulton Drive Columbia, MD 21046-2265	+1 (410) 910 78 00 +1 (410) 910 78 01 rsatv@rsa.rohde-schwarz.com rsacomms@rsa.rohde-schwarz.com
USA	Rohde & Schwarz, Inc. Marketing & Support Center/T&M Equipment 2540 SW Alan Blumlein Way M/S 58-925 Beaverton, OR 97077-0001	+1 (503) 627 26 84 +1 (503) 627 25 65 info@rsa.rohde-schwarz.com
USA	Rohde & Schwarz, Inc. Systems & EMI Products 8080 Tristar Drive Suite 120 Irving, Texas 75063	+1 (469) 713 53 00 +1 (469) 713 53 01 info@rsa.rohde-schwarz.com
Venezuela	Equilab Telecom C.A. Centro Seguros La Paz Piso 6, Local E-61 Ava. Francisco de Miranda Boleita, Caracas 1070	+58 (2) 12 34 46 26 +58 (2) 122 39 52 05 r_ramirez@equilabtelecom.com
Venezuela	Representaciones Bopic S.A. Calle C-4 Ota. San Jose Urb. Caurimare Caracas 1061	+58 (2) 129 85 21 29 +58 (2) 129 85 39 94 incotr@cantv.net
Vietnam	Schmidt Vietnam Co. (H.K.) Ltd., Representative Office Hanoi Intern. Technology Centre 8/F, HITC Building 239 Xuan Thuy Road Cau Giay, Tu Liem Hanoi	+84 (4) 834 61 86 +84 (4) 834 61 88 svnhn@schmidtgroup.com
West Indies	siehe/see Mexico	

Safety Instructions

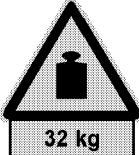
This unit has been designed and tested in accordance with the EC Certificate of Conformity and has left the manufacturer's plant in a condition fully complying with safety standards.

To maintain this condition and to ensure safe operation, the user must observe all instructions and warnings given in this operating manual.

Safety-related symbols used on equipment and documentation from R&S:

							
Observe operating instructions	Weight indication for units >18 kg	PE terminal	Ground terminal	Danger! Shock hazard	Warning! Hot surfaces	Ground	Attention! Electrostatic sensitive devices require special care

1. The unit may be used only in the operating conditions and positions specified by the manufacturer. Unless otherwise agreed, the following applies to R&S products:
IP degree of protection 2X, pollution severity 2 overvoltage category 2, only for indoor use, altitude max. 2000 m.
The unit may be operated only from supply networks fused with max. 16 A.
Unless specified otherwise in the data sheet, a tolerance of $\pm 10\%$ shall apply to the nominal voltage and of $\pm 5\%$ to the nominal frequency.
2. For measurements in circuits with voltages $V_{rms} > 30\text{ V}$, suitable measures should be taken to avoid any hazards.
(using, for example, appropriate measuring equipment, fusing, current limiting, electrical separation, insulation).
3. If the unit is to be permanently wired, the PE terminal of the unit must first be connected to the PE conductor on site before any other connections are made. Installation and cabling of the unit to be performed only by qualified technical personnel.
4. For permanently installed units without built-in fuses, circuit breakers or similar protective devices, the supply circuit must be fused such as to provide suitable protection for the users and equipment.
5. Prior to switching on the unit, it must be ensured that the nominal voltage set on the unit matches the nominal voltage of the AC supply network.
If a different voltage is to be set, the power fuse of the unit may have to be changed accordingly.
6. Units of protection class I with disconnectible AC supply cable and appliance connector may be operated only from a power socket with earthing contact and with the PE conductor connected.
7. It is not permissible to interrupt the PE conductor intentionally, neither in the incoming cable nor on the unit itself as this may cause the unit to become electrically hazardous.
Any extension lines or multiple socket outlets used must be checked for compliance with relevant safety standards at regular intervals.
8. If the unit has no power switch for disconnection from the AC supply, the plug of the connecting cable is regarded as the disconnecting device. In such cases it must be ensured that the power plug is easily reachable and accessible at all times (length of connecting cable approx. 2 m). Functional or electronic switches are not suitable for providing disconnection from the AC supply.
If units without power switches are integrated in racks or systems, a disconnecting device must be provided at system level.
9. Applicable local or national safety regulations and rules for the prevention of accidents must be observed in all work performed.
Prior to performing any work on the unit or opening the unit, the latter must be disconnected from the supply network.
Any adjustments, replacements of parts, maintenance or repair may be carried out only by authorized R&S technical personnel.
Only original parts may be used for replacing parts relevant to safety (eg power switches, power transformers, fuses). A safety test must be performed after each replacement of parts relevant to safety.
(visual inspection, PE conductor test, insulation-resistance, leakage-current measurement, functional test).

continued overleaf

Safety Instructions

10. Ensure that the connections with information technology equipment comply with IEC950 / EN60950.
11. Lithium batteries must not be exposed to high temperatures or fire.
Keep batteries away from children.
If the battery is replaced improperly, there is danger of explosion. Only replace the battery by R&S type (see spare part list).
Lithium batteries are suitable for environmentally-friendly disposal or specialized recycling. Dispose them into appropriate containers, only.
Do not short-circuit the battery.
12. Equipment returned or sent in for repair must be packed in the original packing or in packing with electrostatic and mechanical protection.
13. Electrostatics via the connectors may damage the equipment. For the safe handling and operation of the equipment, appropriate measures against electrostatics should be implemented.
14. The outside of the instrument is suitably cleaned using a soft, lint-free dustcloth. Never use solvents such as thinners, acetone and similar things, as they may damage the front panel labeling or plastic parts.
15. Any additional safety instructions given in this manual are also to be observed.

Table of Contents

	Page
1	Data Sheet
2	Preparations for Use
2.1	Putting into Operation 2.1
2.1.1	Setting up the Receiver 2.1
2.1.2	Rackmounting 2.1
2.1.3	Power Supply 2.1
2.1.3.1	Mains Operation 2.1
2.1.3.2	Operation with Internal Battery 2.2
2.1.3.3	Operation with External Battery 2.4
2.1.4	Switching on 2.4
2.1.5	Selecting the Instrument Presettings (SETUP menu) 2.5
2.2	Function Test 2.7

3	Operating Instructions	3.1
3.1	Explanation of Front and Rear Panel View	3.1
3.1.1	Front View	3.1.1
3.1.2	Rear View	3.15
3.2	Manual Operation	3.20
3.2.1	Connecting the Voltage to be Measured	3.20
3.2.1.1	Sinusoidal Signals	3.20
3.2.1.2	Pulse Signals	3.21
3.2.2	Input of Numeric Values	3.21
3.2.3	Operation of the Receiver Functions	3.22
3.2.3.1	Setting the Receiver Frequency	3.22
3.2.3.1.1	Numeric Input of the Frequency	3.22
3.2.3.1.2	Frequency Setting using the Rotary Knob	3.22
3.2.3.1.3	Frequency Tuning using the and keys	3.23
3.2.3.1.4	Input of Tuning Step Size	3.23
3.2.3.2	Selecting RF Attenuation (ATTENUATION)	3.24
3.2.3.3	Selecting the Operating Mode (MODE)	3.25
3.2.3.4	Automatic Setting of Attenuation (Autorange Operation)	3.26
3.2.3.5	Selecting the Operating Range (OPERATING RANGE)	3.26
3.2.3.6	Level Indication	3.27
3.2.3.6.1	Digital Level Indication	3.27
3.2.3.6.2	Analog Level Indication	3.28
3.2.3.6.3	Overload of the Receiver	3.28
3.2.3.7	Selecting the IF Bandwidth (IF BW)	3.29
3.2.3.8	Selecting the Indicating Mode (DETECTOR)	3.30
3.2.3.8.1	Average Value Measurement(AV)	3.30
3.2.3.8.2	Peak Value (Pk)	3.30
3.2.3.8.3	Quasipeak (QP)	3.32
3.2.3.8.4	Pulse Weighting in Various Indicating Modes	3.32
3.2.3.9	Selecting the Measuring Time (MEAS TIME)	3.33
3.2.3.10	Selecting AF-Demodulation (DEMOD)	3.35
3.2.3.11	Calibration and Measurement Accuracy	3.36
3.2.3.11.1	Error Messages during Calibration	3.38
3.2.3.11.2	Measurement Accuracy	3.39

	Page
3.2.3.12	Special Functions (SPEC FUNC) 3.41
3.2.4.	Operation of the Menu Functions 3.45
3.2.4.1	Input and Editing in the Display DATA INPUT 3.45
3.2.4.1.1	Editing the Menus 3.45
3.2.4.1.2	Input of Texts and Labellings 3.46
3.2.4.2	Configuration of the Receiver (Keypad INSTR STATE) 3.47
3.2.4.2.1	Entering and Calling of Transducer Factors (TRANSDUCER Menu) 3.47
3.2.4.2.2	Calling the Self Test (SELF TEST Menu)..... 3.
3.2.4.3	Execution of Frequency Scans (Keypad ANALYSIS) 3.56
3.2.4.3.1	Generation and Editing of Data for a Frequency Scan 3.56
3.2.4.3.2	Input of Limit Lines 3.60
3.2.4.3.3	Extended Functions of RF-Analysis (OPTIONS) 3.63
3.2.4.3.4	Frequency Scan 3.67
3.2.4.4	Generating a Test Report (Keypad Report) 3.69
3.2.4.4.1	Selecting the Pre-setting of the Printer and Plotter 3.69
3.2.4.4.2	Input of the Labellings for Printer or Plotter Output 3.72
3.2.4.4.3	Output of the Measurement Results on Printer 3.73
3.2.4.4.4	Output of the Measurement Results on Plotter 3.74
3.2.4.5	Saving and Calling the Receiver Configuration 3.76
3.2.5	Connecting External Devices 3.77
3.2.5.1	Connecting the Transducers (ANTENNA CODE) 3.77
3.2.5.2	AF-Output 3.78.
3.2.6	Inputs and Outputs at the Rear Panel 3.78
3.2.6.1	IF-Output 10.7 MHz (10.7 MHz OUTPUT) 3.78
3.2.6.2	Input for External Reference (EXT REF INPUT) 3.78
3.2.6.3	USER INTERFACE 3.79
3.2.6.3.1	Serial Interface (RS-232 C) 3.80
3.2.6.3.2	TTL-I/O-Lines 3.81.
3.2.6.3.3	Trigger Input 3.81.
3.2.6.3.4	Analog Voltages 3.81
3.2.6.3.5	Supply Voltages 3.81
3.2.6.4	Printer Interface 3.82
3.2.6.5	IEC-Bus 3.83.
3.2.6.6	Connecting a Keyboard 3.84

	Page
3.3	Remote Control (IEC-Bus) 3.85
3.3.1	Setting the Device Address 3.86
3.3.2	LOCAL - REMOTE Switchover 3.86
3.3.3	Interface Messages 3.87
3.3.3.1	Universal Commands 3.87
3.3.3.2	Addressed Commands 3.87
3.3.4	Device Messages 3.89
3.3.4.1	Commands Received by the Test Receiver in Listener Mode (Controller to Device Messages) 3.89
3.3.4.2	Messages Sent by the Test Receiver in Talker Mode (Device to Controller Messages) 3.92
3.3.4.3	Common Commands 3.94
3.3.4.4	Device-specific Commands 3.99
3.3.5	Service Request and Status Register 3.109
3.3.6	Resetting of Device Functions 3.117
3.3.7	Command Processing Sequence and Synchronization 3.117
3.3.8	Output of Measured Results via IEC-Bus 3.118
3.3.9	Transfer of the IEC-Bus Controller Function 3.123
3.3.10	Error Handling 3.124
3.4	Applications 3.125
3.4.1	Measuring the RFI Voltage in the Frequency Range up to 30 MHz 3.127
3.4.2	Measuring the RFI Current in the Frequency Range up to 30 MHz 3.134
3.4.3	Measuring the RFI Voltage or the RFI Current in the Frequency Range above 30 MHz 3.135
3.4.4	RFI Fieldstrength Measurement in the Frequency Range up to 30 MHzs . . . 3.135
3.4.5	RFI Fieldstrength Measurement in the Frequency Range above 30 MHzs . . 3.135
3.4.6	RFI Power Measurement Using the Absorbing Clamp 3.148

	Page
3.5	Program Examples3.152
3.5.1	Initialization and Initial State3.152
3.5.2	Sending a Device Setting Command3.153
3.5.3	Reading of the Device Settings3.154
3.5.4	Triggering a Single Measurement and Synchronization using *WAI3.155
3.5.5	Service Request Routine3.156
3.5.6	Synchronization with the End of the Scan using *OPC3.157
3.5.7	Programming a Scan Data Set3.158
3.5.8	Programming a Transducer Factor3.159
3.5.9	Programming a TransducerSet3.160
3.5.10	Output of a Test Report on Plotter3.161
3.5.11	Block-Serial Output of the Scan Results in ASCII Format3.163
3.5.12	Block-Serial Output of the Scan Results in Binary Format3.165
3.5.13	Block-Serial Output of Scan Results in the Internal Data Format (Dump) . 3.169
3.6	Error Messages and Warnings3.144

	Page
4	Maintenance and Troubleshooting4.1
4.1	Maintenance4.1
4.1.1	Mechanical Maintenance4.1
4.1.2	Electrical Maintenance4.1
4.1.2.1	Testing the Level Measuring Accuracy4.1
4.1.2.2	Testing and Adjustment of the Frequency Accuracy4.1
4.1.3	Replacing the Battery4.2
4.2	Function Check and Self-Test4.3
4.2.1	Switch-on Test4.3
4.2.2	Cold Start4.3
4.2.3	Checking the Synthesizer and the Power Supply4.4
4.2.4	Self-Test4.4
4.3	Hints for Loading the Instrument Firmware4.9
4.3.1	Introduction4.9
4.3.2	Hardware Requirements4.9
4.3.3	Files for FLASHUP4.9
4.3.4	Installation4.10
4.3.5	Starting the Firmware Loading Procedure4.10

	Page
5	Testing the Rated Specifications 5.1
5.1	Test Instruments and Utilities 5.1
5.2	Test Sequence 5.2
5.2.1	Frequency Accuracy 5.2.
5.2.2	RF Input 5.2..
5.2.2.1	Input-VSWR 5.2 .
5.2.2.2	Oscillator Reradiation 5.3
5.2.2.3	Interference Rejection 5.3
5.2.2.3.1	Image Frequency of the 1st IF 5.3
5.2.2.3.2	Image Frequency of the 2nd IF 5.4
5.2.2.3.3	IF Rejection 5.4 .
5.2.2.4	Nonlinearities 5.4 .
5.2.2.4.1	3rd-Order Intercept 5.4.
5.2.2.4.2	2nd-Order Intercept 5.5.
5.2.3	IF Bandwidths 5.6 .
5.2.4	Noise Indications 5.7 .
5.2.5	Checking the Inherent Spurious Responses 5.7
5.2.6	Measurement Errors 5.8.
5.2.6.1	Level Measurement Error 5.8
5.2.6.1.1	Frequency Response 5.8.
5.2.6.1.2	Display Linearity 5.11
5.2.6.1.3	Error of the Attenuator 5.12
5.2.7	Testing the Outputs 5.13
5.2.7.1	AF Output 5.13.
5.2.7.2	10.7-MHz Output 5.13
5.2.7.3	User Port 5.14.
5.2.7.3.1	Analog Output 5.14
5.2.8	Testing the Inputs 5.14
5.2.8.1	Checking the External Reference 5.14
5.2.8.2	Checking the Internal Battery Input (Option ESPC-B1) 5.14
5.2.8.3	Checking the External Battery Supply 5.15
5.2.8.4	Checking the Antenna Code Socket 5.15
5.3	Performance Test Report 5.16

Supplement to Data Sheet ESPC

The specified data has been corrected and should read as follows:

Noise indication, average (AV), discrete spuria excepted

9 kHz...3 MHz, B = 200 Hz, with Option ESPC-B2	typ. values see Fig. on page 5, left
150 kHz...3 MHz, B = 10 kHz	typ. values see Fig. on page 5, right
f > 3 MHz, B = 200 Hz	typ. -28 dB μ V
B = 10 kHz	typ. -12 dB μ V
B = 120 kHz	< +3 dB μ V
	typ. -2 dB μ V

Voltage measurement range

Lower limit (additional error due
inherent noise < 1 dB)

Average indication (AV), f > 3 MHz

B = 200 Hz	typ. -24 dB μ V
B = 9 kHz	typ. -8 dB μ V
B = 120 kHz	< +7 dB μ V
	typ. +2 dB μ V

General Data

Rated temperature range	+5 to +45 °C
Operating temperature range	0 to +50 °C (no condensation allowed)
Storage temperature range	-25 to +70 °C



Certificate No.: 9502103

This is to certify that:

Equipment type	Order No.	Designation
ESPC	1082.8007.10	EMI Test Receiver
ESPC-B2	1082.9555.02	Frequency Extension
ESPC-B3	1082.9603.02	Frequency Extension

complies with the provisions of the Directive of the Council of the European Union on the approximation of the laws of the Member States

- relating to electrical equipment for use within defined voltage limits
(73/23/EEC revised by 93/68/EEC)
- relating to electromagnetic compatibility
(89/336/EEC revised by 91/263/EEC, 92/31/EEC)

Conformity is proven by compliance with the following standards:

EN61010-1 : 1991
EN50081-1 : 1992
EN50082-1 : 1992

Affixing the EC conformity mark as from 1995

ROHDE & SCHWARZ GmbH & Co. KG
Mühldorfstr. 15, D-81671 München

Munich, 14.09.95

Central Quality Management FS-QZ / Becker

2 Preparations for Use

2.1 Putting into Operation

2.1.1 Setting up the Receiver

If an angled power plug (R&S-stock no. D50086.4400) and retractable supporting feet at the rear of the instrument are used, the receiver can be operated in any position.

It is however recommended to operate the receiver in horizontal position for the following reasons:

- The analog instrument achieves its highest degree of accuracy in this position.
- The LC-displays can be optimally read when seen obliquely from above; thus the best contrast can be achieved in this position.
- The temperature within the receiver is the lowest in this position, as convection through the perforations in the top and bottom cover is optimal.

For measurements carried out on the test bench, it is recommended to fold out the retractable feet at the bottom of the instrument.

Note: *To ensure proper operation of the receiver, note the following:*

- *Do not cover the ventilation openings!*
- *Ambient temperature - +5 to +55° C*
- *Avoid moisture condensation. If it however occurs, the instrument must be wiped dry before switching-on.*

2.1.2 Rackmounting

The receiver can be mounted into 19"-racks with the help of the rack adapter, type ZZA-95 (order no. 0369.4911.00) in accordance with the mounting instructions supplied. Since the ESPC is not provided with a fan, it is recommended to provide for forced ventilation in the rack.

Note: *As the power switch is situated at the rear of the instrument, an all-pole mains disconnection must be near at hand for safety reasons when the receiver is mounted into the rack.*

2.1.3 Power Supply

The receiver can be supplied either from the mains, an inserted internal battery or an external battery.

2.1.3.1 Mains Operation

The ESPC operates on A.C. supply voltages of 100 V, 120 V and 240 V $\pm 10\%$ and 230 V $+6/-10\%$ and frequencies of 47 to 420 Hz.

Prior to initial switch-on, check whether the ESPC is set to the correct supply voltage. If this is not the case, it must be set in the following way:

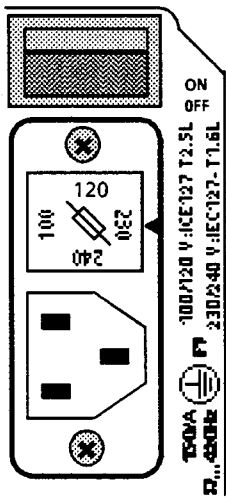

- ▶ Remove the power supply cable.
- ▶ Lever out and withdraw the cover from the voltage selector (rear panel of instrument) using a screwdriver.
- ▶ Take the fuse out of the fuse holder.
- ▶ Insert the fuse that has the necessary value (part of the accessories supplied).
A fuse IEC 127 T2.5L, is required for 100 to 120 V,
a fuse IEC 127 T 1.6 L for 230 to 240 V.
- ▶ Insert the voltage selector such that the white arrow on the fuse holder points to the desired voltage.

Fig. 2-1 Voltage Selector

2.1.3.2 Operation with Internal Battery (Option ESPC-B1)

The ESPC can be operated on two 6-V-, 10-Ah-lead-acid batteries, which are fitted into the instrument (cf. Recommended Accessories). In mains operation (standby mode or the instrument is switched on) the batteries are charged. They also have the function of a buffer in the case of a mains failure.

Fitting the batteries:

- ▶ Unscrew 4 Philips screws of the rear panel feet and withdraw the latter.
- ▶ Remove upper and lower instrument cover backwards.
- ▶ Put the receiver on its top (RF-cabling points to the top).

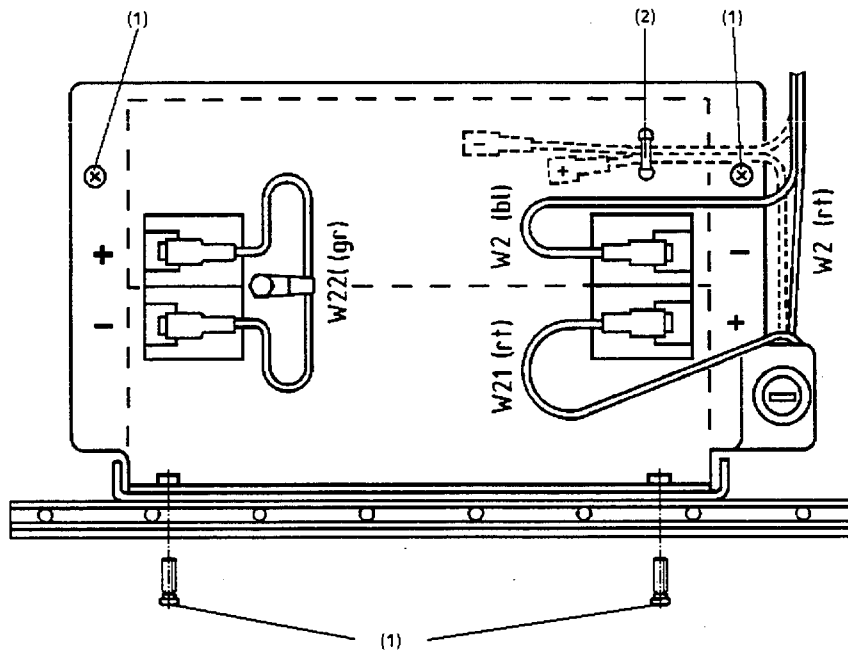

Fig. 2-2 Fitting the batteries

- ▶ Loosen the 4 screws (1) of the cover of the battery holder (two screws at the sides of the frame, two screws of the battery box).
- ▶ Remove the cover of the battery holder.
- ▶ Fit the batteries according to the mounting instructions given on the cover (Pay attention to the poling)
- ▶ Put the cover again on the battery holder and fix it using screws.
- ▶ Connect the cables to the batteries (cf. fig. 2-1).
- ▶ Check whether a suitable battery fuse (F3) is inserted.
Battery fuse: IEC 127 T 6.3L 250 V
- ▶ Slip the top and bottom housing cover on the receiver from the rear side of the housing and mount the rear panel feet by way of screwing.

The receiver can be expected to operate on internal batteries for more than three hours, if the batteries are completely charged and the ambient temperature is $> 25^{\circ}\text{C}$. If the battery voltage is less than 10.8 V, the receiver automatically switches off to avoid harmful overdischarging of the batteries. Following switch-off the STANDBY-LED on the front panel flashes to indicate that the batteries must be charged.

The discharge degree of the batteries can be checked on the display device by pressing the key BATTERY (Fig. 3-1). If the pointer is at the left end of the bold bar (dotted line in fig. 2-3), the battery is almost exhausted. The instrument is near to switching-off. If the pointer is in the upper third of the bar (dashed line in fig. 2-3), the battery is completely charged. During charging the pointer is in the range of the thin bar (dashed-dotted line in fig. 2-3; temperature-dependent end of charge of the batteries).

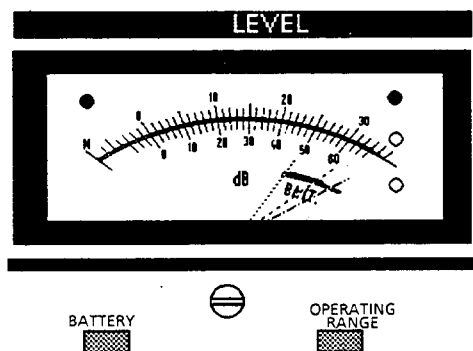

Fig. 2-3 Charge of the batteries

Note: *It is recommended to store the batteries in charged condition, if possible. Batteries that are stored must be recharged after about 12 months, if the average ambient temperature is $+20^{\circ}\text{C}$. The higher the temperatures, the shorter the period after which recharging is necessary.*

The batteries should be stored in dry environment, as moisture leads to conducting compounds between the connecting poles and thus increases self-discharge.

If the batteries are permanently used at high temperatures, their service life is reduced. Permanent capacity losses may arise. Continuous use at temperatures above $+50^{\circ}\text{C}$ should therefore be avoided.

The display light and IEC bus are not switched off automatically when supplying the test receiver from an internal battery. We recommend you to switch them off by way of special functions 10 and 11 in order to increase the battery life.

2.1.3.3 Operation with External Battery

The instrument can be supplied from an external d.c. voltage source via the connector "BATTERY 11...33 V" situated at the rear of the instrument. Due to the wide voltage range it can be supplied both from a 12-V-battery and a 24-V-battery. The battery connector required is contained in the accessories supplied. The battery is connected to the instrument in the following way:

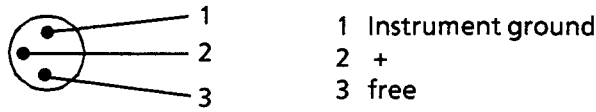

(External battery input 25)

Fig. 2-4

The receiver is protected against reverse voltage applied to the battery connector, i.e. a wrongly connected supply will not lead to damages.

Substitute fuses for operation with external battery are contained in the accessories (IEC 127 T 6.3L 250 V).

If the A.C. supply is connected to the receiver at the same time, the latter is supplied only from this supply. The external battery is then not charged. Battery back-up with external battery is possible, but whenever it is switched from A.C. supply to external battery an instrument reset takes place.

During operation the external battery voltage can be continuously increased from 11 V to 33 V without the instrument switching off. When however the voltage is increased to more than 15.5 V or decreased to under 14.5 V, an instrument reset occurs, which is due to the internal switch-over of the switching power supply from 24-V-operation to 12-V-operation. When the receiver is supplied from a 12-V- or 24-V- battery, this is not of importance as in this case the voltages stated above never occur. If the instrument is however operated on an external generator, this fact must be considered.

Note: *The ESPC can only be switched on if the voltage at the battery connector is at least 12 V. During operation, the voltage may be maximally reduced to 11 V. The reason for this is an internal switch-on hysteresis which prevents the instrument from being switched on and off continuously with an almost flat battery. In practice, this does not imply any restriction, since the open-circuit voltage of an intact 12-V battery is always at least 12 V*

2.1.4 Switching-on

a) A.C. supply operation:

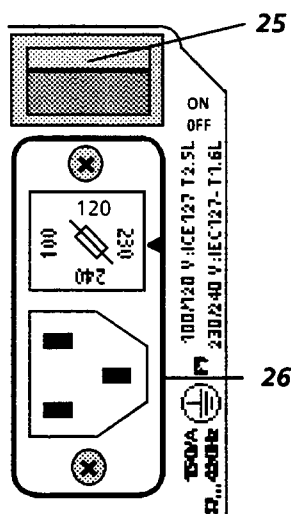

- ▶ Connect the mains cable to the mains connector **26** (rear panel of instrument).
- ▶ Press rocker switch **25** (rear panel of instrument) to ON. If the instrument is supplied from the mains, the LED STANDBY on the front panel flashes. It also indicates whether an internal battery that may be available is being charged.
- ▶ Press the switch-on key. The receiver is switched on and the LED ON on the front panel flashes. When the power supply functions correctly, the LED "SUPPLY OK" at the rear panel of the instrument flashes. It also indicates that all internal voltages are within the permissible range.

Fig. 2-5

b) Operation with internal or external battery

If the receiver is operated on internal or external battery (A.C. power supply is not connected), the instrument is switched on using the ON STANDBY switch on the front panel (pos. 9, cf. fig. 3-1). The power switch on the rear panel is without any meaning. If the instrument is switched on, the LED ON flashes. If the voltage of the internal battery or the external supply is not sufficient for operation, the LED STANDBY flashes and thus indicates that the battery must be charged.

Following switch-on the following text appears on the display DATA INPUT:

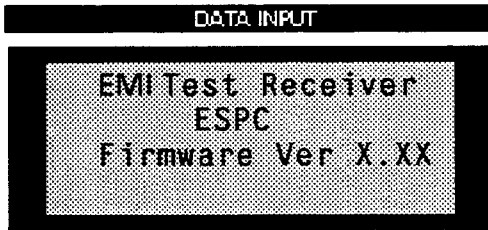

Fig. 2-6 Display after switching on

The receiver is set to basic setting and shows the level applied to the RF input.

2.1.5 Selecting the Instrument Presettings (SETUP menu)

The presettings

- input of date and time,
 - selection of the IEC-bus address (IEC 625),
 - selection of user port switching outputs (see 3.2.6.3.2)
 - display of the firmware version and
 - operation with external reference
- are indicated or can be newly entered in the SETUP menu.

Operation:

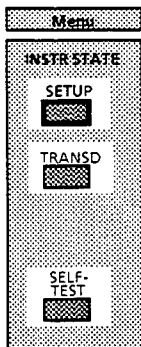

- ▶ Press SETUP key.
The following menu appears in the DATA INPUT display:

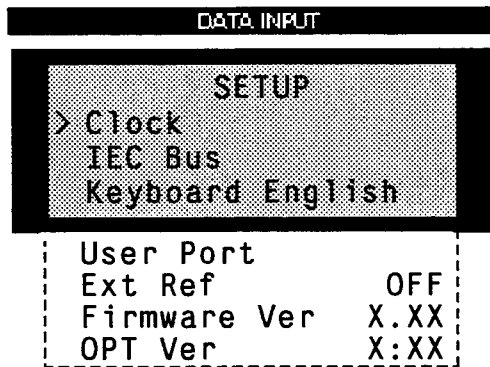

In the last line the reference frequency currently used (*Int Ref* with device-internal reference or *Ext Ref* with external reference frequency, cf. section 3.2.6.4) are displayed. When pressing the ↓ key, the firmware version available in the receiver (*Firmware Ver*) and the version of the boot PROM (*OTP Ver*; OTP = one time programmable ROM) are read out.

The desired function (clock or IEC 625) is selected by placing the ↑ or ↓ keys of the EDIT keypad on it and then pressing ENTER or by the → key. The firmware version and reference indication cannot be selected. A submenu appertaining to each menu point subsequently appears. The respective entries can be made in the submenus.

Setting the internal clock:

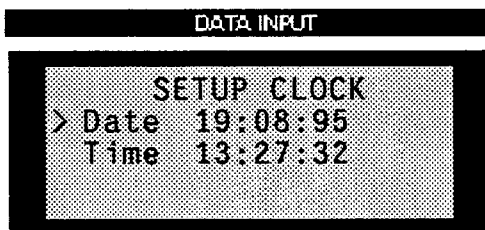

Fig 3-11 Display of date and time

The current date and time are contained in the realtime clock of the receiver and are displayed after having called the clock function. If a re-entry is required, e.g. following a change of the internal battery, the respective line for the date or time must be selected using the cursors of the EDIT keypad and then input must be performed using the numeric keypad DATA. Illegal entries are ignored, i.e. the former value is retained. The date is displayed in the order day:month:year and time in the 24-hours format hours:minutes:seconds.

After having terminated the input of the date by way of ENTER the cursor moves to time. Following the entry of time the SETUP menu appears again.

Selecting the IEC-bus address:

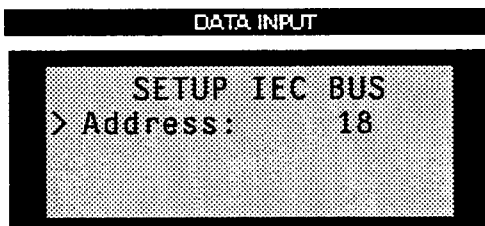
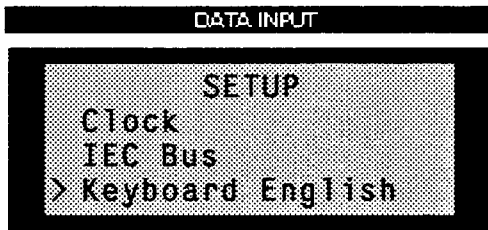

Fig 3-12 Display of IEC-bus address

Values between 0 and 30 are permissible for the IEC-bus address. The default setting is 17. Illegal inputs are ignored.

Configuration of the external Keyboard:



The mode of the external keyboard can be switched between English and German using one of the ENTER keys toggling the function "Keyboard English" / "Keyboard German". The setting also affects the Auxiliary Line Editor (see Section 3.2.4.1.2)

2.2 Function Test

The function test of the ESPC is carried out in the following stages:

- Automatic test when switching-on the receiver,
- Total calibration, which ensures correct operation when it has been successfully completed, and
- Self-test, which checks all of the modules at significant points and indicates errors via display, once it is called by the user.

When switching-on the receiver all functions of the processor are initialized and thus simultaneously checked and the test A/D-converter automatically adjusted.

Information on the calibrations is given in section 3.2.3.11, self-tests and error messages are described in section 4.

Cold Start:

Pressing the decimal point in the numeric keypad during switch-on sets all the functions of the ESPC to their default status. The memory with battery back-up is cleared, i.e. all the stored settings, limit lines and transducer factors get lost. An extensive computer hardware test is subsequently performed in addition to the normal switch-on test. The message *INI COLD* is read out in the LEVEL display during the test. If a computer hardware error not permitting further operation was detected, the message *ERR CPU* is output in the DATA INPUT display.

After successful completion of the extended switch-on test, the receiver is set to its default status.

Note: *After a "cold start" of the receiver (or when a new firmware has been loaded), a total calibration is to be performed as the correction values were completely erased.*

3 Operating Instructions

3.1 Explanation of Front and Rear Panel View

3.1.1 Front View

1

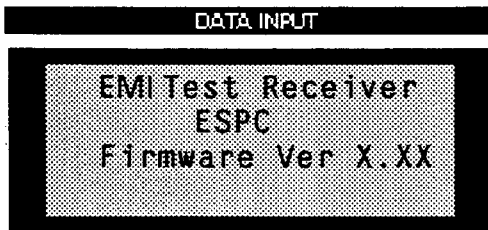

Menu input display for ANALYSIS, INSTR STATE and REPORT, 4 lines with 20 characters each, editing with DATA (cf. section 3.2.2)

2

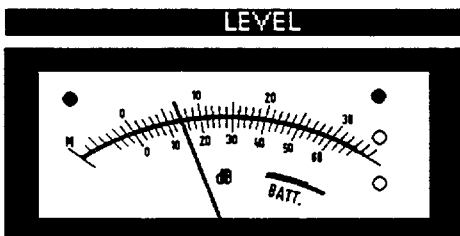

- Moving coil instrument with scales for the 30-dB- and 60-dB-operating ranges;
- Display of battery voltage and mechanical zero display;
- Setting screw for the mechanical zero;
- Yellow LEDs for indicating the operating range;
- Red LEDs for indicating whether the operating range (upper or lower limit) is exceeded (cf. section 3.2.3.6.3)

3



BATTERY: Key for indicating the charge of battery (cf. section 2.1.3.2)

OPERATING RANGE: Key for switching-over the operating range (cf. section 3.2.3.5)

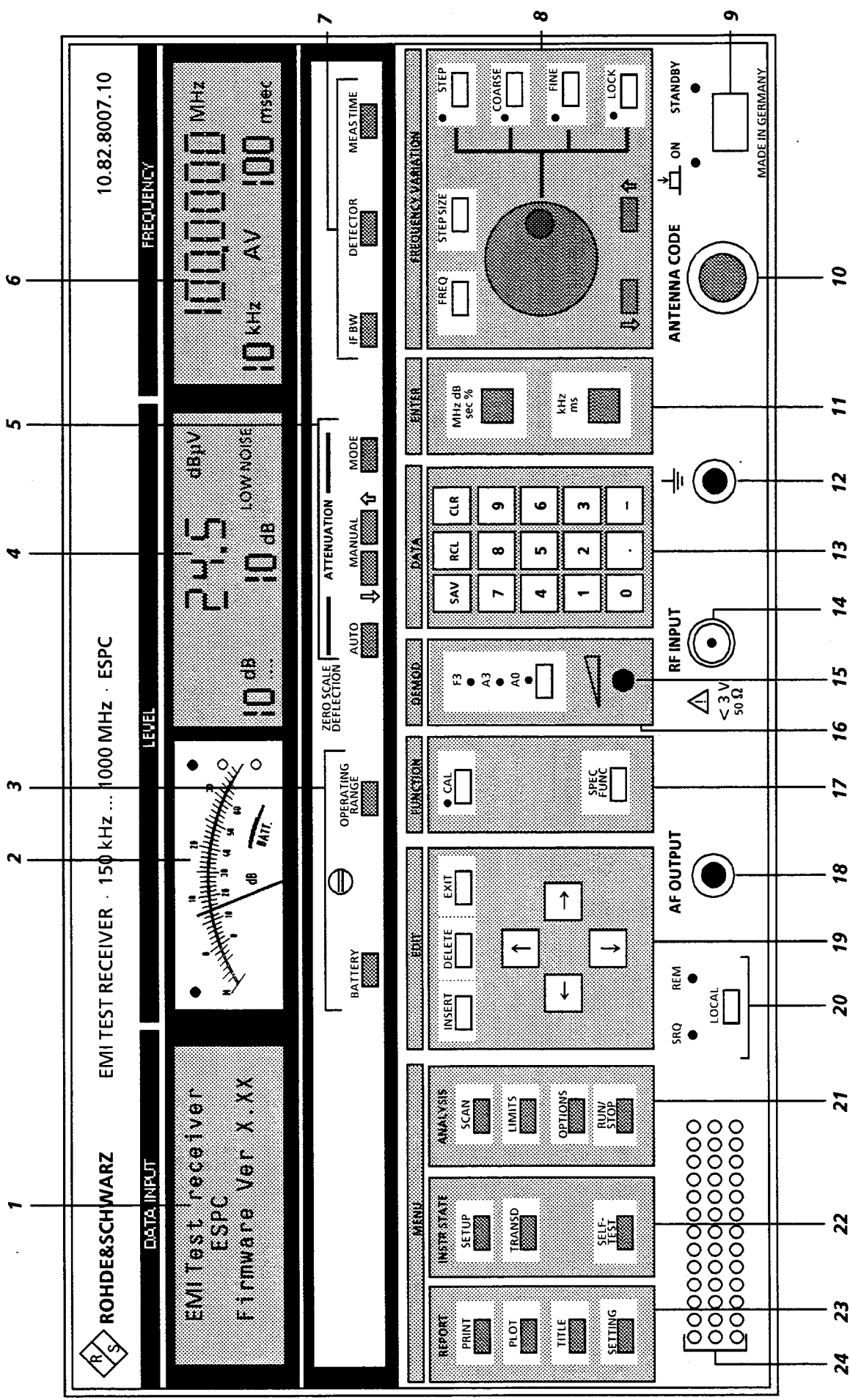
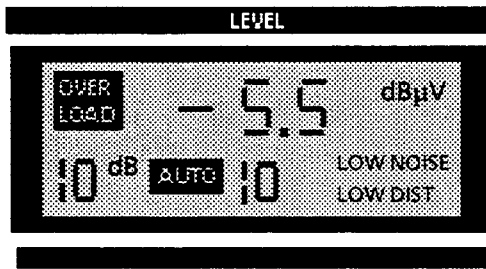
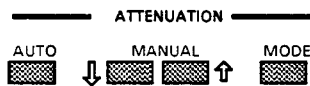

Fig. 3-1 Front panel view



ZERO SCALE
DEFLECTION

- 3 1/2-digit display of the level applied to RF-input, resolution 0.1 dB
Units:
dBµV, dBµA, dBm, dBµV/MHz, dBµA/MHz, dBµV/m, dBµV/m/MHz, dBµA/m, dBµA/m/MHz, dBpW
- Display of overload of the signal path (OVERLOAD)
- Display of measurement mode (MODE): LOW NOISE and LOW DIST (low-distortion) (sect. 3.2.3.3)
- Display of RF attenuation (RF ATT) 0 to 70 dB (cf. section 3.2.3.2)
- Display of automatic operation (AUTO) (cf. section 3.2.3.4)
- Display of lower limit of the scale span (ZERO SCALE DEFLECTION) (cf. section 3.2.3.6)



Attenuation

AUTO: RF-attenuation and MODE are automatically adjusted to input signal (cf. section 3.2.3.5)

MANUAL: Switch-over of RF-attenuation:
↑ increasing by 10 dB, ↓ decreasing by 10 dB (cf. section 3.2.3.2)

MODE: Switch-over of IF-attenuation (LOW NOISE/LOW DISTORTION) (cf. section 3.2.3.3)

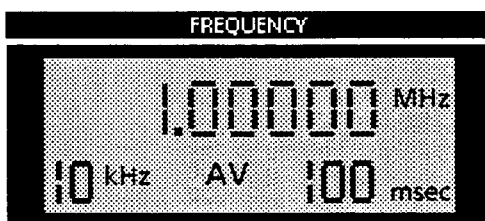

- 7-digit display of receiver frequency resolution 10 and 100 Hz, unit in MHz and kHz (cf. section 3.2.3.1)
- Display of measuring time, 1 ms to 100 s in 1, 2, 5-steps, (cf. section 3.2.3.9)
- Indication of detector: AV, Pk, and QP, (cf. section 3.2.3.9)
- Indication of IF-bandwidths 200 Hz, and 10 kHz (cf. section 3.2.3.7)

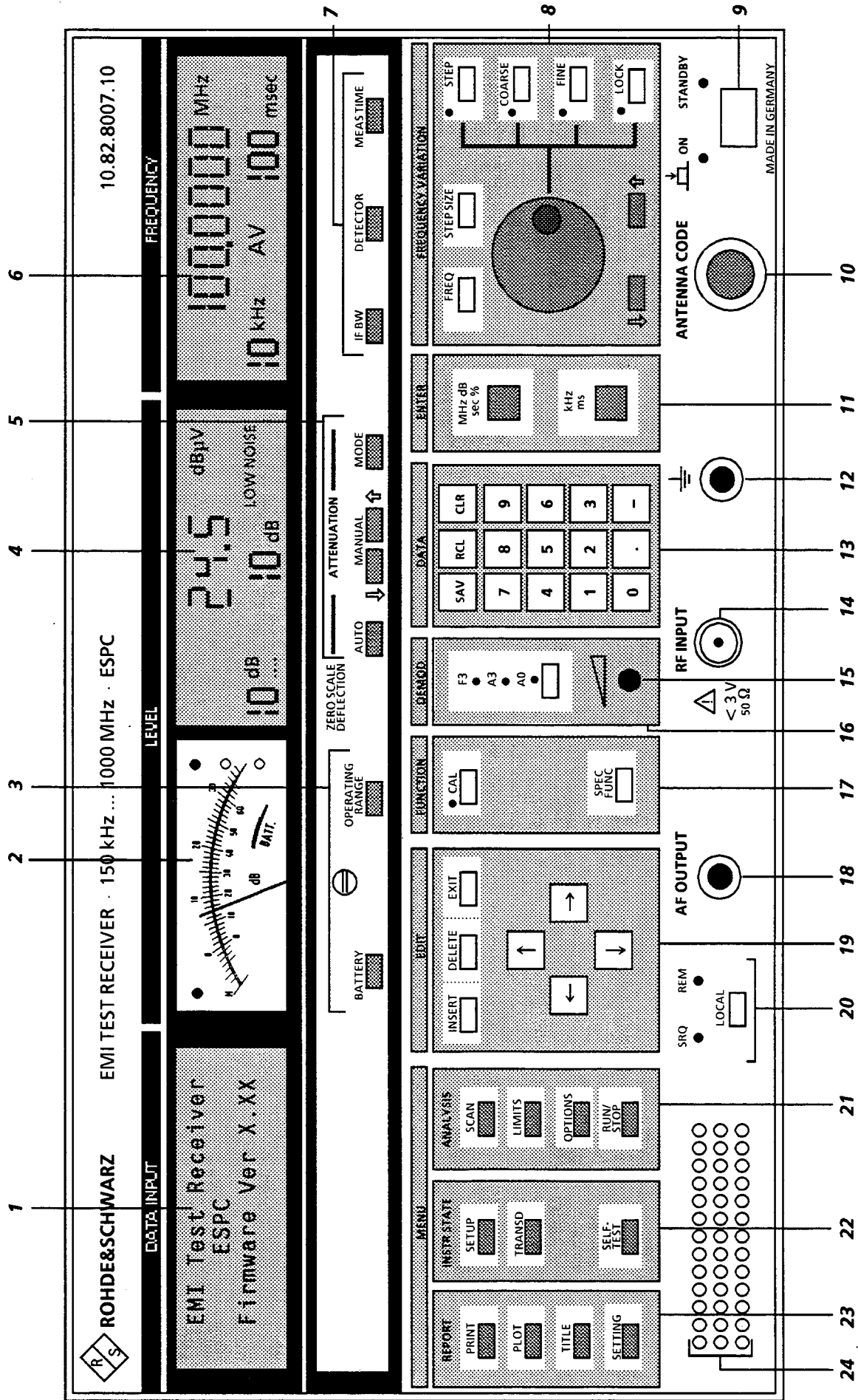

Fig. 3-1 Front panel view

7



- IF BW: Key for switching over IF-bandwidth
- DETECTOR: Key for switching over the weighting (cf. sect. 3.2.3.9)
- MEAS TIME: Key for activating input of measuring time (cf. section 3.2.3.10)

8

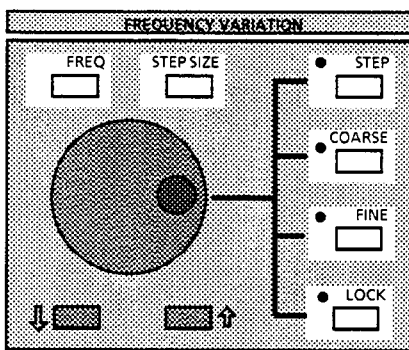

- Frequency tuning knob
- FREQ: key for input of frequency
- STEP SIZE Input of tuning step size
- STEP: Tuning in the step size entered in STEP SIZE
- COARSE: Frequency tuning coarse (100-kHz steps)
- FINE: Frequency tuning fine (10- and 100-Hz steps)
- LOCK: Lock key
- ↑ Frequency is increased by the step size entered in STEP SIZE
- ↓ Frequency is reduced by the step size entered in STEP SIZE (cf. section 3.2.3.1)

9

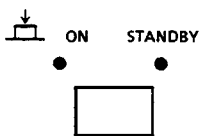

On/Standby switch

10



- Supply and code socket for connecting active and passive measuring transducers:
- Output: + 10 V, -10 V, max. 50 mA
- Input: Coding for level display (cf. section 3.2.5.1)

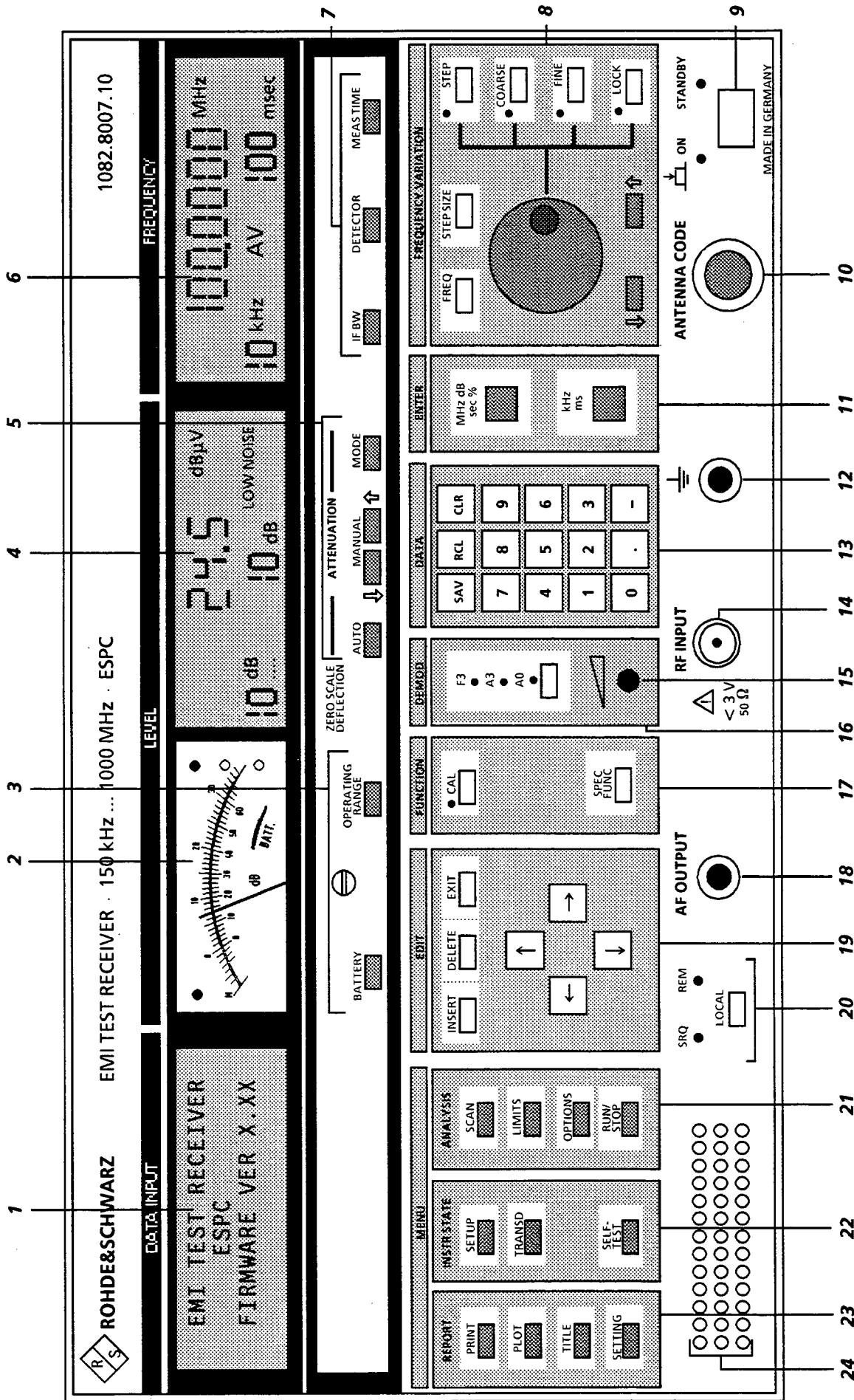
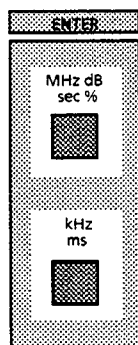

Fig. 3-1 Front panel view



Input keys:

MHz dB

sec %: Input key for the units MHz, dB, seconds and % or for entries without unit

kHz

ms: Input key for the units kHz and milliseconds or for entries without unit (cf. section 3.2.2)



Socket for connecting measuring earth

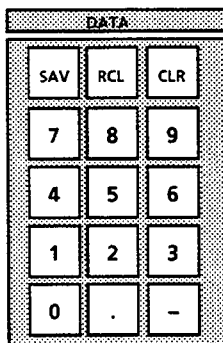

Numeric keypad

SAV (0 to 9): Storing of instrument settings (cf. section 3.2.4.5)

RCL (0 to 9): Calling of stored settings (cf. section 3.2.4.5)

CLR: Deleting the character last entered

0 to 9: Numeric input keypad

- Minus sign

. : Decimal point (cf. section 3.2.2)

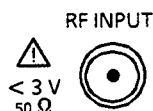

RF-input, N-input socket, 50Ω , $< 3 V$ (cf. section 3.2.1)

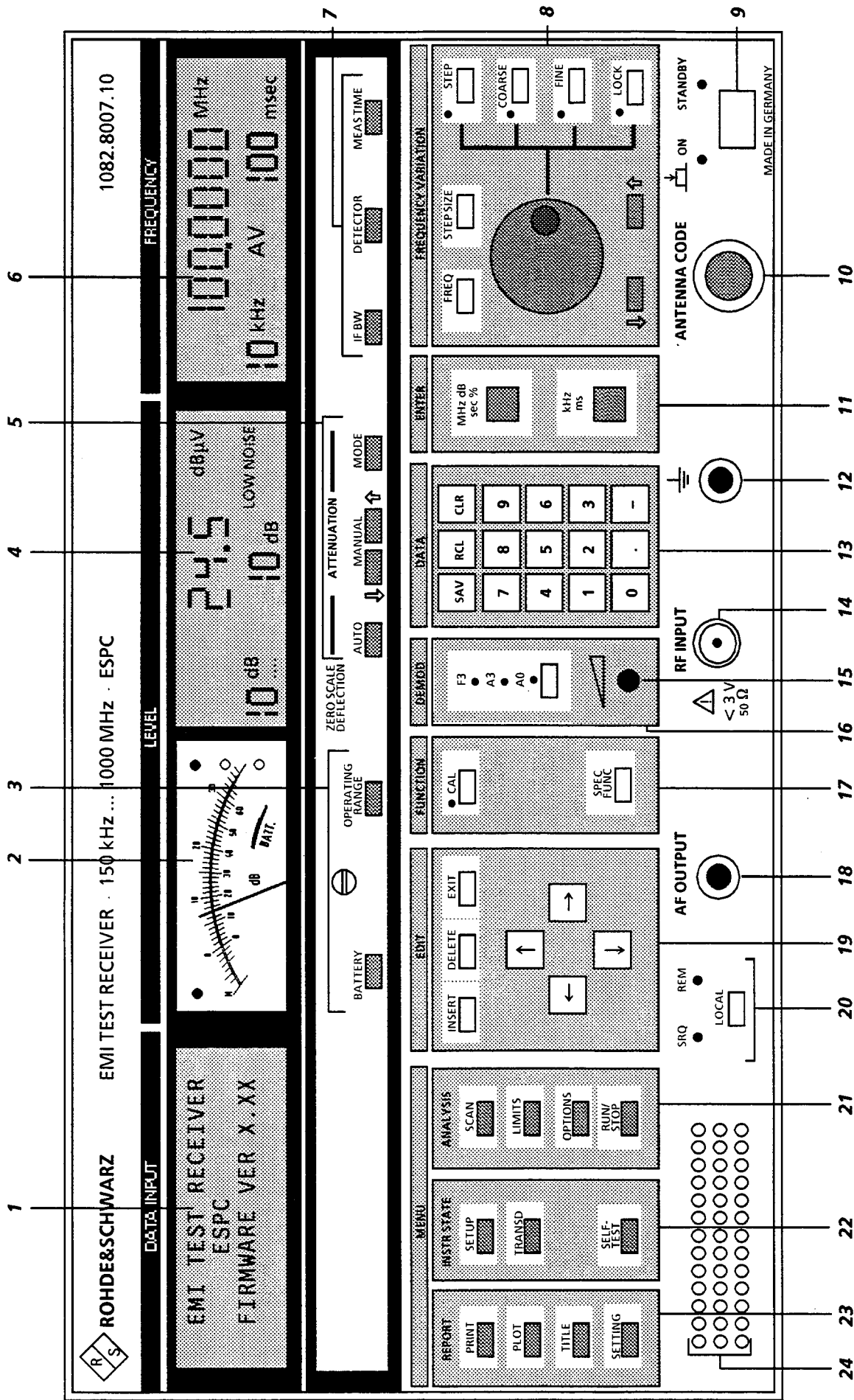

Fig. 3-1 Front panel view

15



Rotary knob for setting the volume.
(cf. section 3.2.3.11)

16

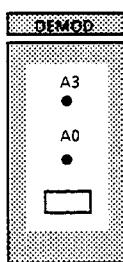

A3: Indicates when AM-demodulation is switched on

A0: Indicates when A0-demodulation is switched on

Key for switching-over the mode of demodulation
(cf. section 3.2.3.10)

17

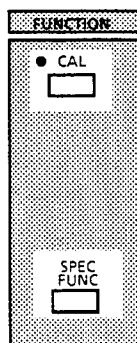

CAL: Initiating calibration process
short key depression → short CAL
long key depression → total CAL
(cf. section 3.2.3.11)

SPEC FUNC: Calling the special function menu
(cf. section 3.2.3.12)

18



AF-output connector (JK 34)
with break contact for loudspeaker;
 $R_i = 10 \Omega$; $P > 100 \text{ mW}$

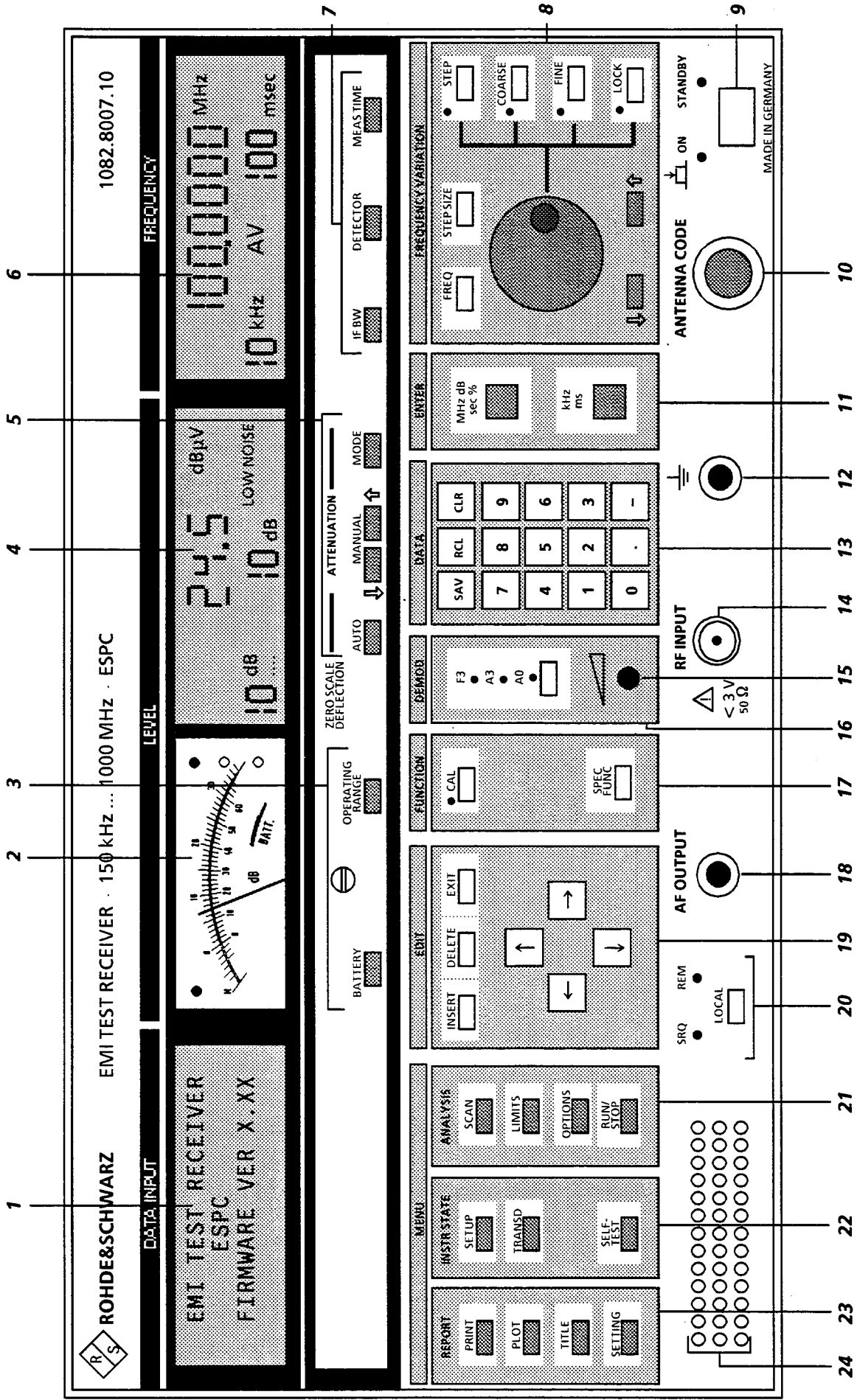
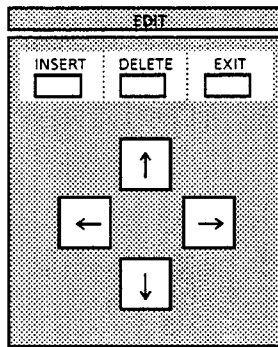
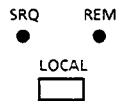

Fig. 3-1 Front panel view



Editing function of display DATA INPUT:

- EXIT:** Exiting the current menu (cf. section 3.2.4.1)
- INSERT:** Inserting in already existing lists (cf. section 3.2.4.1)
- DELETE:** Deleting input lines or -characters (cf. section 3.2.4.1)
- : The cursor moves to the right or to the next submenu, (cf. section 3.2.4.1)
- ←: The cursor moves to the left or one menu back, (cf. section 3.2.4.1)
- ↑: The cursor moves one line up (cf. section 3.2.4.1)
- ↓: The cursor moves one line down (cf. section 3.2.4.1)



- SRQ:** LED indicates service request present at IEC-bus (cf. section 3.3)
- REM:** LED for indicating remote control of ESHS (cf. section 3.3)
- LOCAL:** Key for switching from remote control to manual operation (cf. section 3.3).

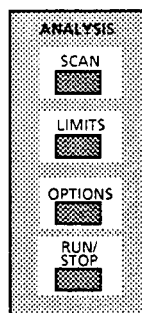

- SCAN:** Calling the menu for input of scan data sets (cf. section 3.2.4.1.1)
- LIMITS:** Calling the menu for input of limit lines (cf. section 3.2.4.3.2)
- OPTIONS:** Calling the menu for input of special measurements and complex procedures (cf. section 3.2.4.3.3)
- RUN/STOP:** Key for starting or stopping a frequency scan (cf. section 3.2.4.3.4)

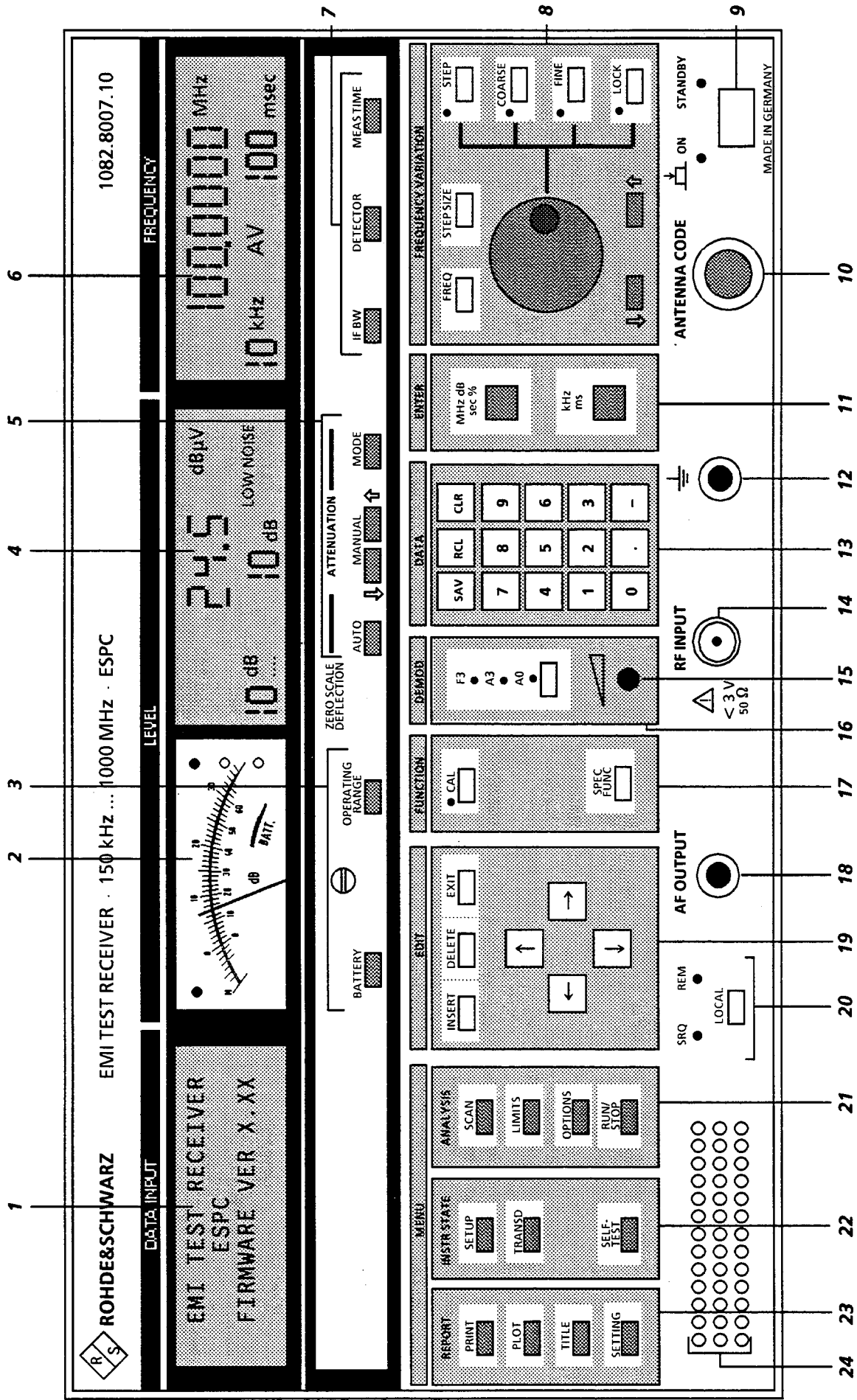
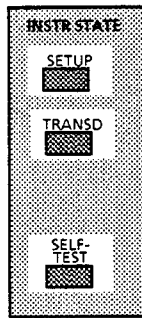
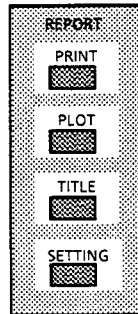

Fig. 3-1 Front panel view



- SETUP: Calling the menu for the instrument default settings (cf. section 2.1.5)
- TRANSD: Calling the menu for input of transducer factors (cf. section 3.2.4.2.1)
- SELF TEST: Calling the menu for instrument self-test (cf. section 3.2.4.2.2)



- PRINT: Selecting printer output (cf. section 3.2.4.4.3)
- PLOT: Selecting plotter output (cf. section 3.2.4.4.4)
- TITLE: Calling the menus for input of headers for printer or plotter output (cf. section 3.2.4.4.2)
- SETTING: Calling the menu for presetting the instrument for output (cf. section 3.2.4.4.1)

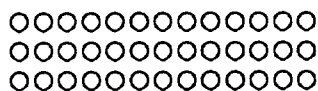

Internal loudspeaker, which is switched off when a connector is inserted into the socket AF OUTPUT.

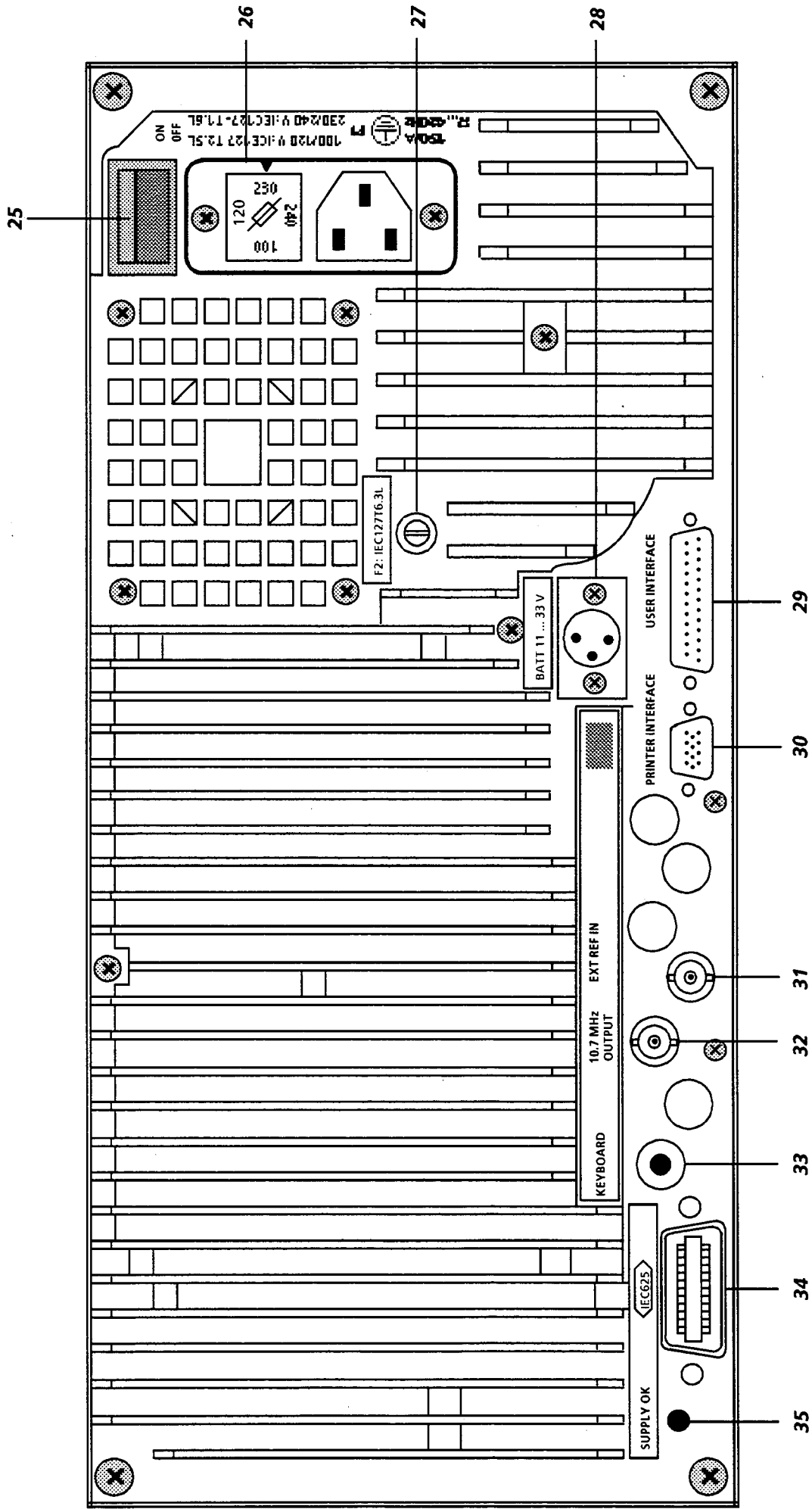
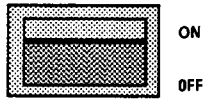

Fig. 3-2 Rear panel view

3.1.2 Rear View

25



Power switch

26

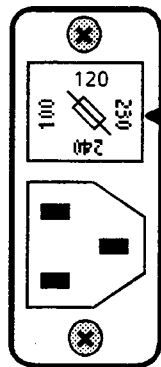

Power input with integrated voltage selector and power fuse (cf. section 2.1.3.1)

27

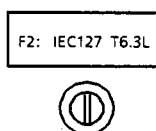

Fuse for external battery,
F2: IEC 127 T6,3L 250 V
(cf. section 2.1.3.3)

28

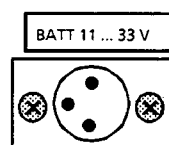

Input for an external battery 11 to 33 V,
3-pole special connector; (cf. section 2.1.3.3)

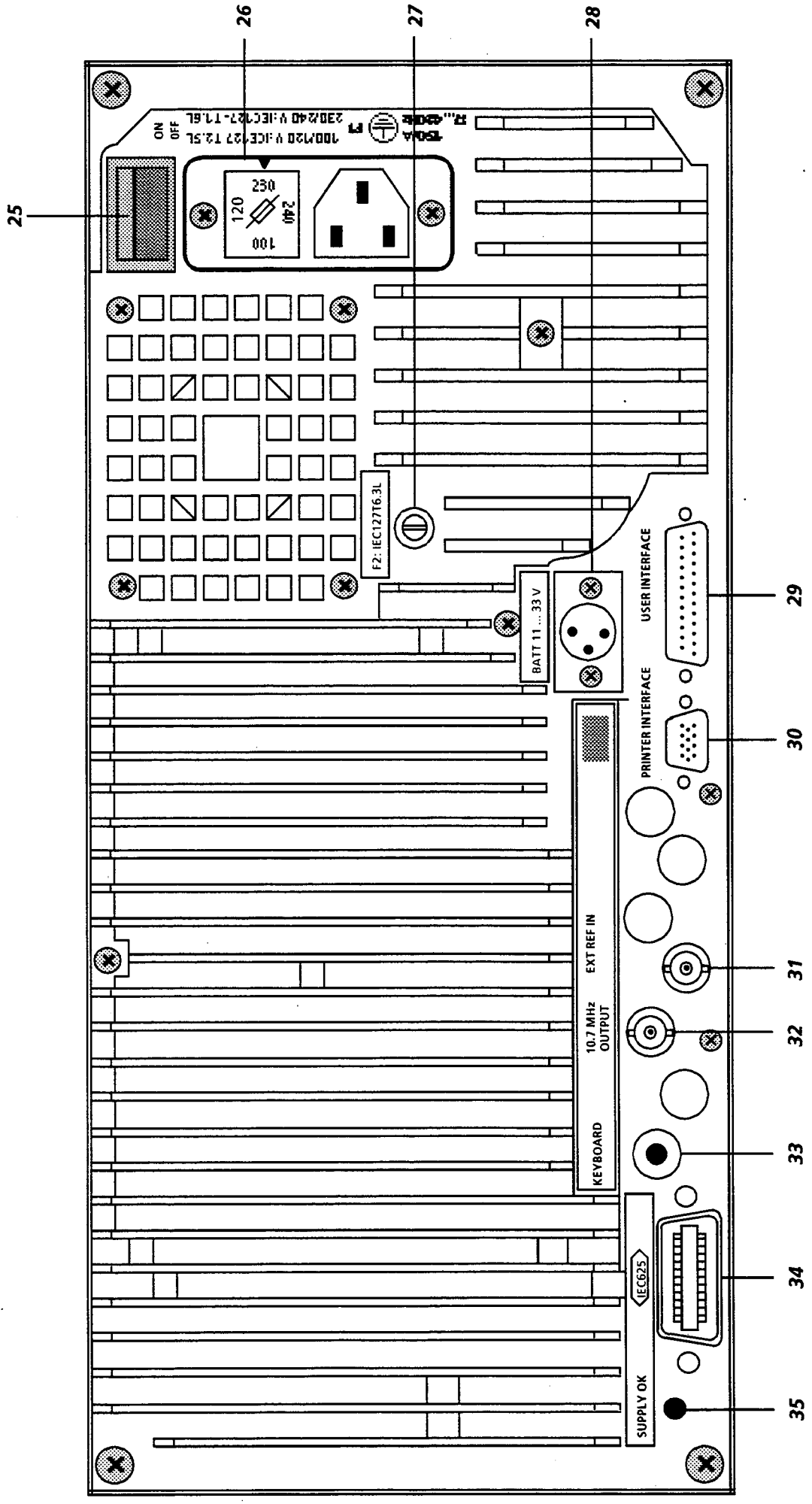
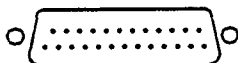

Fig. 3-2 Rear panel view

29

USER INTERFACE



User interface with various inputs and outputs, 25-pole female connector (cf. section 3.2.6.5)

30

PRINTER INTERFACE



Parallel interface for connecting a printer, 15-pole female connector (cf. section 3.2.6.6)

31

EXT RF IN



BNC-socket for connecting an external reference, 5 or 10 MHz (cf. section 3.2.6.3)

32

80 kHz
OUTPUT



BNC-socket for output of the 2nd IF (80 kHz) (cf. section 3.2.6.2)

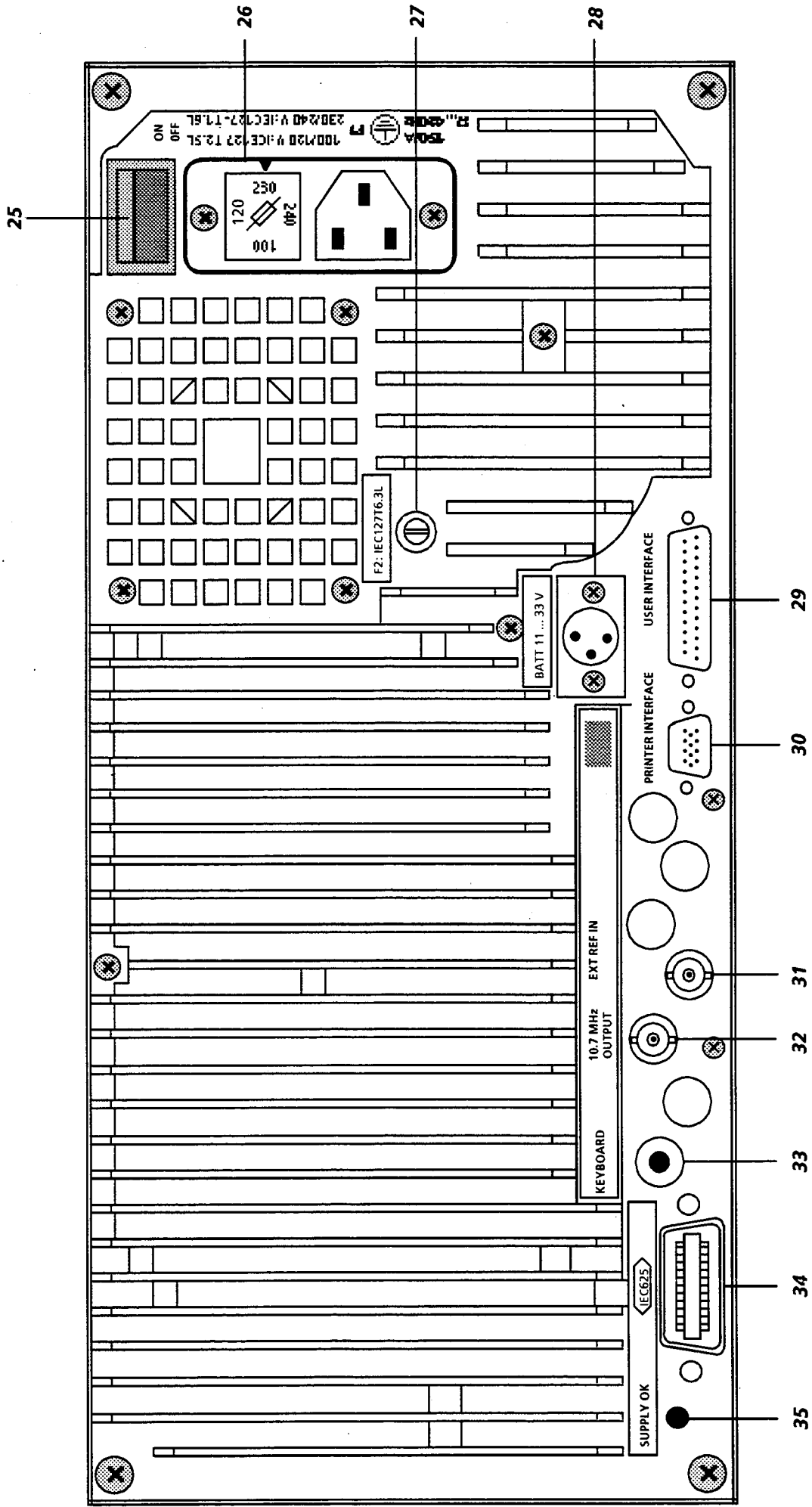

Fig. 3-2 Rear panel view

33

KEYBOARD



Connection for external keyboard
(cf. section 3.2.6.8)

34

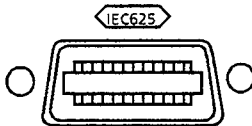

IEC-bus interface, 25-pole female connector
(cf. section 3.2.6.7)

35

SUPPLY OK



LED flashes when all the internal supply
voltages of the power supply are correct.

3.2 Manual Operation

Manual operation of Test Receiver ESPC can be divided into two groups: operation of the receiver functions and that of the menus calling complex measurement runs.

The receiver functions are:

- frequency input,
- selecting attenuation (RF attenuation and IF attenuation),
- selecting IF bandwidth,
- selecting weighting mode (detector),
- selecting measuring time,
- selecting operating range,
- selecting AF demodulation,
- testing the internal battery,
- level indication (analog and digital),
- calibration of receiver and
- use of the various special functions.

The menus include:

- selecting the receiver configuration,
- use of transducer factors (transducer),
- setting and performing frequency scans,
- input of limit lines,
- carrying out special measurements (OPTIONS) during frequency scan,
- output of measurement results on printer or plotter,
- input of headers for printer- or plotter outputs,
- setting the printer or plotter configuration and
- carrying out the self-test.

3.2.1 Connecting the Voltage to be Measured

The voltage to be measured is connected to the RF INPUT via a 50- Ω -coaxial cable. The input resistance of the receiver is 50 Ω . The ESPC measures sinusoidal and pulse voltages within the frequency range of 150 kHz (9 kHz when option ESPC-B2 is fitted) to 1000 or 2500 MHz when option ESPC-B2 is fitted. The total voltage of all signals that may be applied to the input socket of the receiver without causing any permanent damage depends on RF attenuation (cf. Specifications).

3.2.1.1 Sinusoidal Signals and DC Voltage

With an RF attenuation of 0 dB the RMS value of the total voltage applied to the RF input may not exceed 3 V at 50 Ω . For RF attenuations \geq 10 dB the total voltage may not be more than max. 7 V. The max. dc voltage with all RF attenuations is also 7 V.

3.2.1.2 Pulse Signals

With an RF attenuation of 0 dB the pulse spectral density must not exceed 97 dB μ V/MHz at 50 Ω . As described in section 3.2.3.4 (autorange operation), after switch-on of the receiver, RF attenuation is more than 10 dB, if attenuation is set automatically. If, however, automatic operation is switched on with an RF attenuation of 0 dB set, this value is also used in autorange operation. Manual setting of RF attenuation prevents that an RF attenuation of 0 dB is activated during autorange operation.

With an RF attenuation > 0 dB the max. permissible pulse energy at 50 Ω is 10 mWs.

The input attenuator, pre-amplifier, preselection filter or input mixer may be destroyed, if these values are exceeded. For higher voltages as occur e. g. with measurements at ignition cables using the absorbing clamp MDS 21 it is recommended to use the external Pulse Limiter ESM3-Z2 (see Recommended extras on page 8 of EMPC data sheet). This 10-dB attenuator pad which can be switched into circuit is designed for pulse voltages up to max. 1500 V and for pulse energies up to 100 mWs. It is automatically switched on by the ESPC if RF attenuation exceeds 10 dB, thus protecting the receiver input from destruction.

3.2.2 Input of Numeric Values

The numeric keypad DATA (pos. 13, cf. fig. 3-1) and the unit field ENTER (pos. 11) are used for the input of figures both in the receiver part and menu part.

The keys SAV and RCL that serve to save and call instrument settings are dealt with in section 3.2.4.5. Numeric values are input in accordance with the following flowchart:

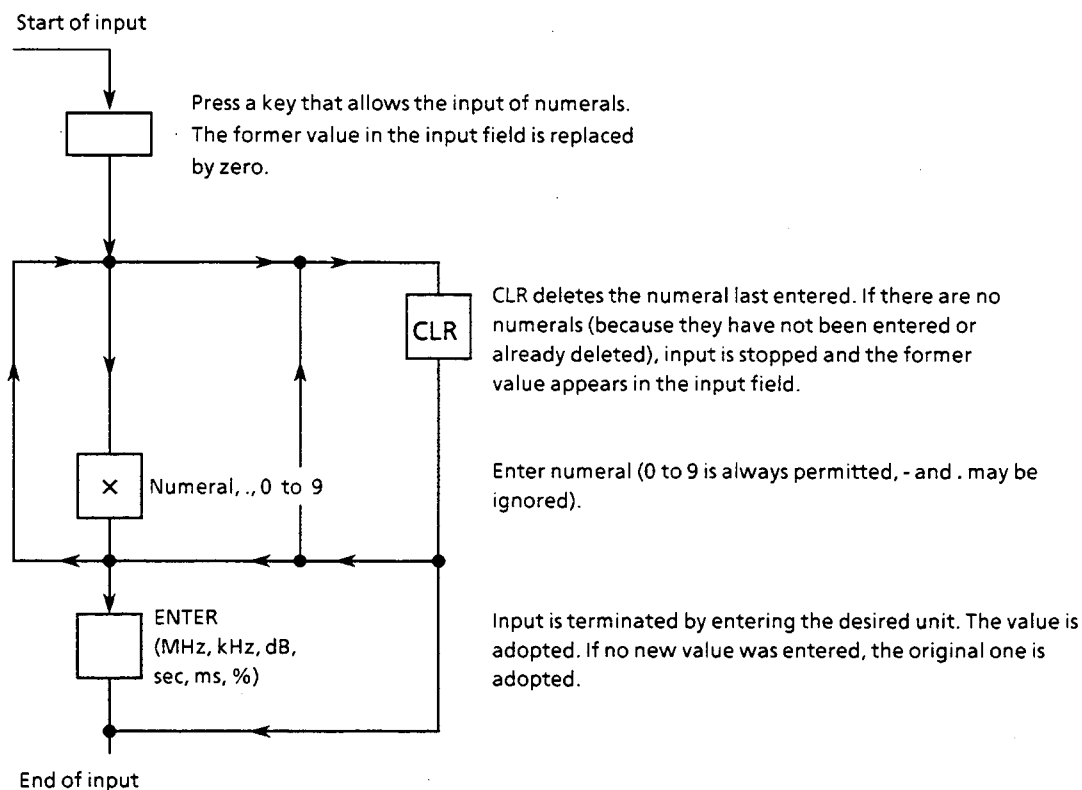

Fig. 3-3 Flowchart for the input of numeric values

3.2.3 Operation of the Receiver Functions

3.2.3.1 Setting the Receiver Frequency

The frequency of the receiver can be entered using the rotary knob, the upward/downward keys or via the numeric keypad (13) after having pressed the **FREQ** key. When setting frequency with rotary knob, frequency increment or decrement is selected using the functions **STEP**, **COARSE** and **FINE**.

3.2.3.1.1 Numeric Input of Frequency

The desired receiver frequency in the range of 9 or 150 kHz to 1000 or 2500 MHz can be entered directly using the **FREQ** key in the keypad **FREQUENCY VARIATION**. Following the activation of the **FREQ** key, the current receiver frequency, which is shown in the display **FREQUENCY**, is cleared and a new one can be entered as described in section 3.2.2.

3.2.3.1.2 Frequency Setting using the Rotary Knob

The rotary knob in keypad **FREQUENCY VARIATION** serves only for varying the frequency. Independently of any other selected input function, the frequency can always be tuned using this knob.

The step size with which frequency is tuned can be selected using the keys **STEP**, **COARSE**, **FINE** and **LOCK**. The step size selected is indicated by an LED next to the corresponding key. Tuning is performed in the step sizes given in the following table:

Table 3-1:

Tuning in Position	Step Size in frequency range < 1000 MHz	Step Size in frequency range \geq 1000 MHz (option ESPC-B3)
COARSE	100 kHz	100 kHz
FINE	100 Hz	100 Hz
LOCK	Rotary knob is blocked	Rotary knob is blocked
STEP	0 Hz to 1000 MHz (cf. section 3.2.3.1.4)	0 Hz to 1000 MHz (cf. section 3.2.3.1.4)

When the rotary knob is turned slowly, every step between detent positions corresponds to a frequency step. To allow for comfortable tuning of the receiver over relatively wide frequency ranges, tuning is additionally accelerated when the knob is turned quickly.

3.2.3.1.3 Frequency Tuning using the ↓ and ↑ keys

If signals in known frequency steps are to be measured, it is useful to step through the receiver frequency in their distance. This is for example the case with harmonics of the clock frequency of processors. For this purpose the ↓ and ↑ keys are provided in the keypad FREQUENCY VARIATION. Frequency is changed in the step sizes entered with the help of STEP SIZE (cf. section 3.2.3.1.4) using these keys. In addition the receiver frequency can be fine-tuned using the rotary knob in position FINE, when for example the maximum of a harmonic wave is to be determined in the case of a source that is not frequency-stable. Fine-tuning is taken into account when changing the frequency the next time using the ↓ and ↑ keys, i.e. the receiver proceeds taking the new frequency as basis.

3.2.3.1.4 Input of Tuning Step Size

Any step size for tuning the receiver frequency can be input using the STEP SIZE key in the keypad FREQUENCY VARIATION. The defined step size is used when tuning the frequency with the ↓ and ↑ keys or with the tuning knob in the step size setting STEP.

Operation:

Step size is entered as follows:

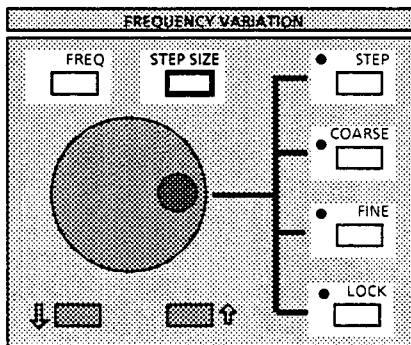

► Press STEP SIZE key.

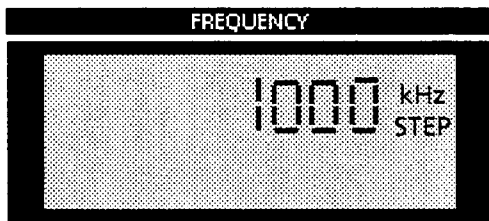

The frequency in the display FREQUENCY disappears and instead the step size currently set is indicated with the additional remark *STEP*.

When entering a figure the former step size is no longer displayed and the figure is shown in the display (input cf. section 3.2.2)

The step size ist variable between 0 kHz and 1000 MHz.

After termination of input, the receiver frequency is shown again in the display FREQUENCY with the unit MHz or kHz.

3.2.3.2 Selecting RF Attenuation (ATTENUATION)

Attenuation of the RF input divider can be set in 10-dB steps in the range of 0 to 120 dB. The attenuator at the input is AC-coupled for protection against high-energy pulses of low frequency. The test receiver may have somewhat less accuracy in the 0-dB position as a result of the higher input reflection coefficient ($VSWR < 2$). In the case of quasipeak measurements in accordance with CISPR 16, minimum attenuation of 10 dB must therefore be switched on ($VSWR < 1.2$).

Operation:

RF attenuation is increased or decreased in 10-dB steps using the \downarrow and \uparrow keys in the ATTENUATION keypad. When pressing the respective key for a longer time (> 1 s) the repetition function is switched on, i.e. attenuation is stepwise switched.

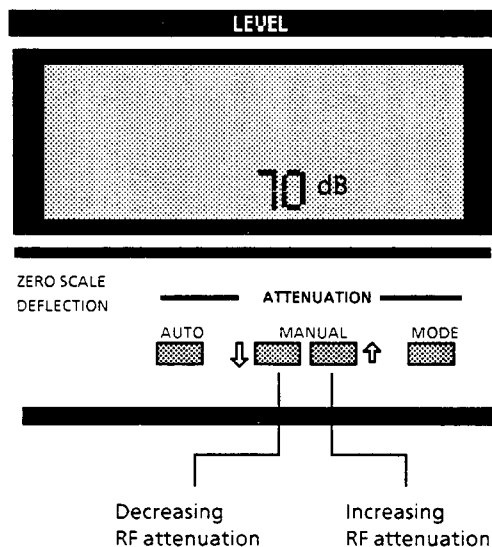

The RF attenuation selected is shown in the LEVEL display.

3.2.3.3 Selecting the Operating Mode (MODE)

The ESPC provides the operating modes LOW NOISE (low-noise measurement) and LOW DISTORTION (low-distortion measurement). When measuring in the latter mode IF gain of the receiver is set such that the noise indication is always below the beginning of the meter scale (ZERO SCALE DEFLECTION). The set IF gain is a function of the selected detector and IF bandwidth. In the LOW NOISE mode the IF gain is by 10 dB lower and consequently the input level of ESPC giving the same meter deflection 10 dB higher than in the LOW DISTORTION mode. As a result the signal-to-noise ratio for signals within the permissible meter range is 10 dB higher than in the LOW DISTORTION mode. With manual attenuator setting in the LOW DISTORTION mode the maximum receiver sensitivity is obtained because of the higher IF amplification. With automatic attenuator setting (AUTO key pressed) and low signal-to-noise ratio, the IF gain is automatically set so that maximum sensitivity is achieved independent of the selected operating mode.

The LOW DISTORTION mode should be used when low signal levels are to be measured in the vicinity of strong interference signals or when quasi-peak display has been selected at a low pulse frequency. For obtaining the same meter deflection, an RF attenuation 10 dB higher than that of the LOW NOISE mode has to be selected. As a result signals are reduced by 10 dB at the input mixer thus loading the input less.

In the case of uncritical measurements, the LOW NOISE mode should be used as in this case a higher measurement accuracy can be expected because of the higher signal-to-noise ratio.

Operation:

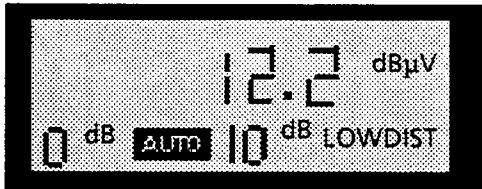

ZERO SCALE
DEFLECTION

ATTENUATION

MODE: switch-selected LOW NOISE/LOW DISTORTION



The set mode is shown in the LEVEL display.

3.2.3.4 Automatic Setting of Attenuation (Aurange Operation)

With automatic operation selected, the receiver sets the RF attenuation and the operating mode (MODE) such that the level applied to the RF input is always within the valid operating range. The input mixer has to be protected against spikes as may be caused when the DUT is switched on or upon switchover of the measurement path between phase and neutral wire with an artificial mains network connected. In the basic receiver setup (special function 00), an attenuation of at least 10 dB is permanently set in the aurange mode and after receiver switch-on. An RF attenuation of 0 dB in aurange mode is only used when this value is set when automatic operation is selected. The 0-dB setting can be cancelled by switching off the aurange mode and switching it on again after setting an RF attenuation of ≤ 10 dB. When measuring RFI voltages with an external Pulse Limiter ESH23-Z2 or in the case of RFI fieldstrength measurements, this protective measure is not appropriate for reasons of sensitivity. In this case select special function 03 (Min ATT 10 dB...on/off; see section 3.2.3.12) to allow the use of 0-dB attenuation. When the ESPC is switched off with the 0-dB attenuation set, this value is reset upon switching on the instrument again. The following criteria are of importance for setting the optimum attenuation:

- the overload at the positions critical in the receiving path,
- the peak value at the output of the envelope demodulator and
- the measured value in the set indicating mode (DETECTOR).

Settings in keeping with these criteria make sure that levels measured in aurange operation are valid in any case and not invalidated by overloading in a receiver stage.

Hysteresis for changing over attenuation at the lower end of the operating range prevents continuous switching on and off of attenuation due to varying input levels.

Operation:

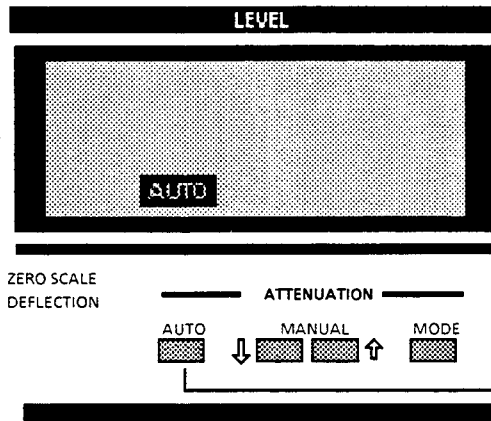

Switch for automatic operation.
Automatic operation is indicated by inverse display of the word AUTO in the LEVEL display.

Automatic operation can be switched off by

- pressing the AUTO key or
- manual switching of attenuator

3.2.3.5 Selecting the Operating Range (OPERATING RANGE)

The ESPC offers the operating ranges 30 dB and 60 dB. In both ranges the analog indication is dB-linear, i.e. the indication voltage is indicated logarithmically.

The 30-dB range offers the advantage of a higher resolution on the analog instrument.

Recording of strongly varying signals without attenuation switch-over is facilitated in the 60-dB operating range. The step size of the level switch in automatic operation is thus larger than in the 30-dB range. The relation between step size of attenuation and operating range is shown in the following table:

Table 3-2

Operating Range	Attenuation Step
30 dB	10 dB
60 dB	30 dB

In the 60-dB range measuring speed during a frequency scan is higher, if there is a strongly varying spectrum and therefore the attenuator need not be switched over so often as in the 30-dB range. In addition the signal-to-noise ratio is increased in the upper half of the operating range. For this reason the 60-dB range should be used in the case of automatic attenuator setting.

Note: Although the nominal operating ranges are specified only with 30 or 60 dB, it is possible to measure to the noise limit with only slightly reduced accuracy at ambient temperatures of between + 15° C and + 30° C. This means that, e.g in the 60-dB range, indication is linear up to 10 dB below the beginning of the range (= 70-dB range).

Operation:

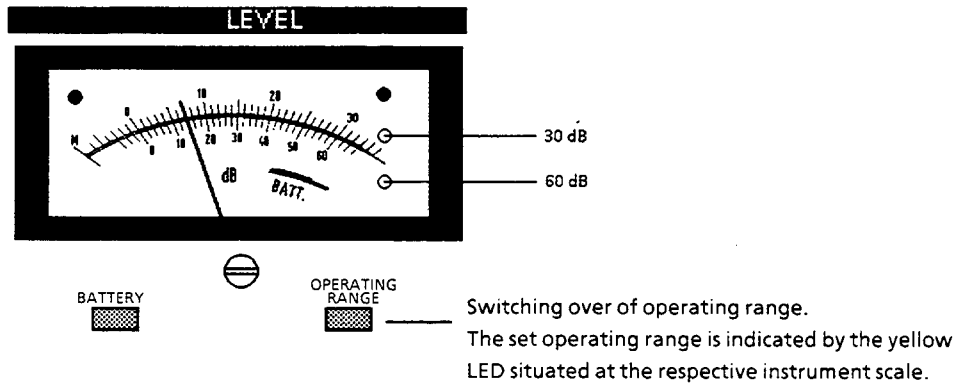

3.2.3.6 Level Indication

The measured level is displayed both by the analog meter (2) and digitally in the display LEVEL (4).

3.2.3.6.1 Digital Level Indication

Compared to analog indication, digital level indication has the advantage of being more accurate since the correction values for the linearity of the rectifier and that of the logarithmic amplifier which are both determined during total calibration are part of the value displayed. Resolution of the digital display is 0.1 dB in a range of -200 to +200 dB. If indication exceeds the value 200 due to the theoretically possible selection of a transducer of up to ± 200 dB, the level is output with a resolution of 1 dB on the LEVEL display. The unit of the measured quantity is also indicated. The basic unit of the indication is $\text{dB}\mu\text{V}$. Other units can be selected by coding the connector ANTENNA CODE (cf. section 3.2.5.1), entering a transducer factor (cf. section 3.2.4.2.1) or by way of special functions (cf. section 3.3.2.3.11). The following units are possible:

Table 3-3

$\text{dB}\mu\text{V}$	Voltage applied to 50Ω at RF input of receiver
$\text{dB}\mu\text{A}$	For current measurement, settable by coding connector ANTENNA CODE or by the unit of the transducer factor.
$\text{dB}\mu\text{V/m}$	Electrical fieldstrength, settable by coding connector ANTENNA CODE or by the unit of the transducer factor.
$\text{dB}\mu\text{A/m}$	Magnetic fieldstrength, settable by the unit of the transducer factor.
$\text{dB}\mu\text{V/MHz}$	Spectral pulse voltage density, switched on by the unit of the transducer factor
$\text{dB}\mu\text{A/MHz}$	Spectral pulse current density, settable by coding connector ANTENNA CODE or by the unit of the transducer factor
$\text{dB}\mu\text{V/m/MHz}$	Spectral pulse density of the electrical fieldstrength, settable by coding connector ANTENNA CODE or by the unit of the transducer factor
$\text{dB}\mu\text{A/m/MHz}$	Spectral pulse density of the magnetic field strength, settable by the unit of the transducer factor in indicating mode Pk/MHz
dBpW	Power in dB relating to 1 picowatt, settable by the unit of the transducer factor
dBm	Power in dB relating to 1 milliwatt, settable by way of special function 20

3.2.3.6.2 Analog Level Indication

The level of analog indication is the result of adding the value for ZERO SCALE DEFLECTION in display LEVEL to that of the meter display in the selected operating range.

Zero scale deflection is indicated in 10 dB steps so that the addition can be performed without using any further means.

Example:

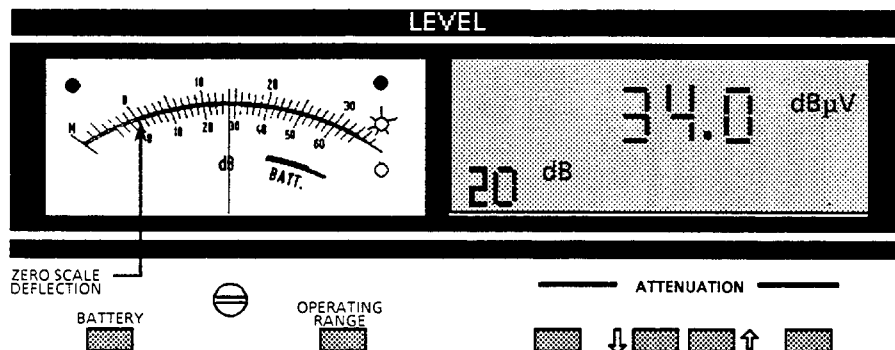

$$\text{Meßwert: } 14 \text{ dB} + 20 \text{ dB} = 34 \text{ dB}\mu\text{V}$$

The unit of the digital measured value is also valid for indication on the analog meter.

Non-decadic transducer factors or the pseudo unit dBm, too are correctly taken into account with analog indication. In this case the complete tens digit is added to zero scale deflection whereas the one digit and the digit after the comma are added internally to the instrument voltage by way of a digital/analog converter. The operating range of the instrument is thus usually shifted, either to higher or to lower values (max. 6 dB). For this purpose, the 30- and 60-dB scale is extended by 6 dB at the upper and lower end of the scale respectively. To ensure that the user detects exceedings of the operating range (higher or lower), a red LED flashes at the upper or lower end of the scale.

3.2.3.6.3 Overload of Receiver

Although analog level indication is within the valid range, the receiver may be overloaded. This is, e.g. the case when a relatively weak signal is within the measuring bandwidth, however a strong signal is present outside the range. This strong signal may overload the stages before the IF filter. For this reason in the ESPC, the level is monitored at this critical positions. If a stage in the signal path is overloaded, the user will be informed about this by the message OVERLOAD on the LEVEL display.

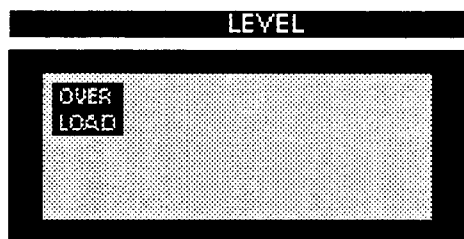

To guarantee correct measurement RF attenuation must be switched on additionally until OVERLOAD display disappears. In autorange operation, attenuation is automatically set such that no overload occurs.

3.2.3.7 Selecting IF Bandwidth (IF BW)

Due to the narrow specification of a 6-dB-drop, the 10-kHz bandwidth meets the requirements of CISPR 16, band B (150 kHz to 30 MHz) and VDE 0876 as well as of various military standards that require tolerances of 10% for a 10-kHz measurement bandwidth.

The 120 kHz bandwidth meets the tolerance for the bandwidth of bands C and D (30 to 1000 MHz) specified in CISPR 16 or VDE 0876.

With receiving frequencies of under 150 kHz, the 200-Hz bandwidth is always recommended for use since the oscillator for first conversion is not suppressed sufficiently with the 10-kHz bandwidth and thus the sensitivity of the receiver is considerably reduced.

The 200-Hz bandwidth meets the tolerance for the bandwidth of band A (9 kHz to 150 kHz) specified in CISPR 16 or VDE 0876.

All filters have optimal settling characteristics and are thus suitable for average measurement of pulse signals in accordance with CISPR 16.

In the indication mode quasi-peak (QP) bandwidth is linked to the receiver frequency. In band A ($f_{rec} < 150$ kHz) the 200-Hz bandwidth, in band B ($f_{rec} \geq 150$ kHz) the 10-kHz bandwidth and in bands C/D ($f_{rec} \geq 30$ MHz) the 120-kHz bandwidth is automatically switched on.

Effective selectivity of the filters is shown in the following figure:

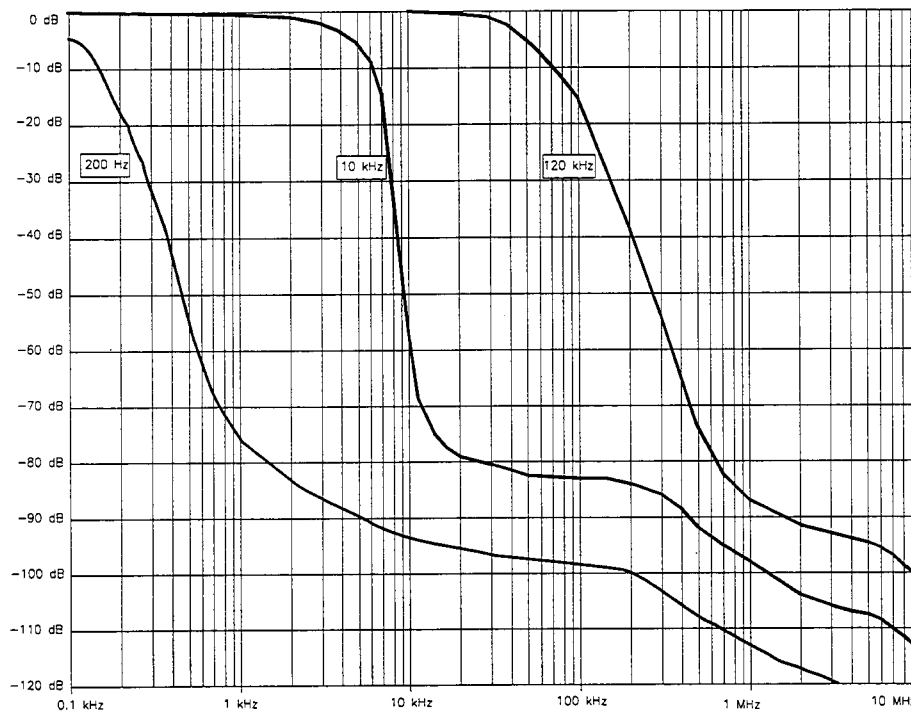
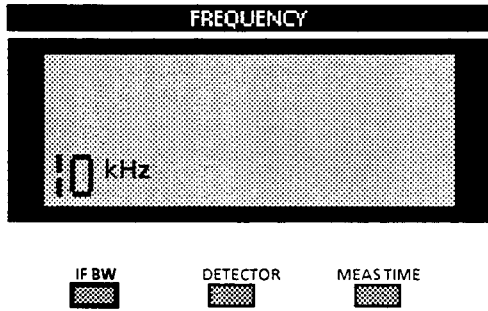

Fig. 3-4 Dynamic IF selectivity

Operation:



- ▶ Press IF BW key.
IF bandwidth is switched over (120 kHz → 10 kHz) and the newly set IF bandwidth is underlined to indicate that a new entry is possible using the numeric keypad DATA.
- ▶ Press ENTER key.
The bar disappears again (input of bandwidth is inactive).

3.2.3.8 Selecting the Weighting Mode (DETECTOR)

The indicating mode specifies how to weight the envelope of the IF signal. The weighting modes (detectors) average value (AV), peak value (Pk) and quasipeak value (QP) can be switched on in the ESPC. The consequences brought about by the selection of indicating mode is explained in the following paragraphs.

3.2.3.8.1 Average Measurement (AV)

In the case of average measurement the linear time-averaged value of the rectified voltage at the output of the envelope demodulator is indicated. It is calibrated using the RMS value of an unmodulated sinusoidal signal. If an unmodulated sinusoidal signal is applied to the receiver input, its RMS value is thus indicated; if an AM signal is present, the RMS value of the carrier is indicated.

With the ESPC, averaging is performed analog using lowpass filters, the time constants of which are switched over depending on the measuring time (cf. section 3.2.3.9). Weighting of pulses is described in sections 3.2.3.8.5 and 3.2.3.9.

3.2.3.8.2 Peak Value (Pk)

In the case of peak value measurement, the maximum value of the rectified voltage at the output of the envelope demodulator within the selected measuring time is indicated. It is calibrated using the RMS value of an unmodulated sinusoidal signal that supplies the same detection voltage. Average and peak value of an unmodulated sinusoidal signal result basically in the same indication. As, however, with peak value weighting, the noise voltage indication is about 11 dB higher than with average weighting, higher values are indicated when the signal-to-noise ratio is not sufficient (refer also to section 3.2.3.11.4, measuring accuracy).

Peak value indication serves for determining the levels of keyed carriers or pulse signals or peak voltages of AM signals. As peak value measurement can be carried out considerably faster than quasipeak measurement, with RFI measurements it is recommended to first perform a general measurement in indicating mode Pk and then a quasipeak measurement at the critical frequencies.

3.2.3.8.3 Quasipeak (QP)

Quasipeak measurement weights pulse signals using a quasipeak detector with defined charge and discharge time. IF bandwidth and mechanical time constant of the meter are also specified. The characteristics the receiver has in this indication mode are defined in CISPR 16 or in VDE 0876. The most important parameters are listed in the following table:

Table 3-4

	CISPR Band C/D	CISPR Band B	CISPR Band C/D
Frequency range	30 to 1000 MHz	150 kHz to 30 MHz	30 to 1000 MHz
IF bandwidth	120 kHz	9 kHz	120 kHz
Charge time of QP-detector	1 ms	1 ms	1 ms
Discharge time of QP-detector	550 ms	160 ms	550 ms
Time constant of meter	100 ms	160 ms	100 ms

The meter time constant of ESPC is simulated electrically, so that it is also effective with digital indication. The instrument, itself, operates much quicker so that its own time constant does not affect the measurement result.

Due to the long time constants of weighting, it takes relatively long until a valid measurement result is displayed after every change in frequency or attenuation at the receiver. It is therefore futile to use measuring times of less than 1 s, especially in the case of automatic measurements.

The maximum value of level during the measuring time set is shown by the digital level display. The time varying quasi-peak test voltage can be observed at the analog meter. This often allows - apart from listening in to the interference source - to draw useful conclusions as to the character of the interference.

Although quasipeak weighting makes high demands on the dynamic characteristics of the receiver, with the ESPC the operating range can be selected without any restrictions. With low pulse frequencies the 60-dB range, however, cannot be made full use of as otherwise RF input would be overloaded. When overload occurs the user is informed about it by way of the overload indication (OVERLOAD) in the LEVEL display. The user should increase RF attenuation to such an extent that the overload message disappears. In automatic operation the receiver, itself, sets attenuation correctly.

3.2.3.8.4 Pulse Weighting in Various Weighting Modes

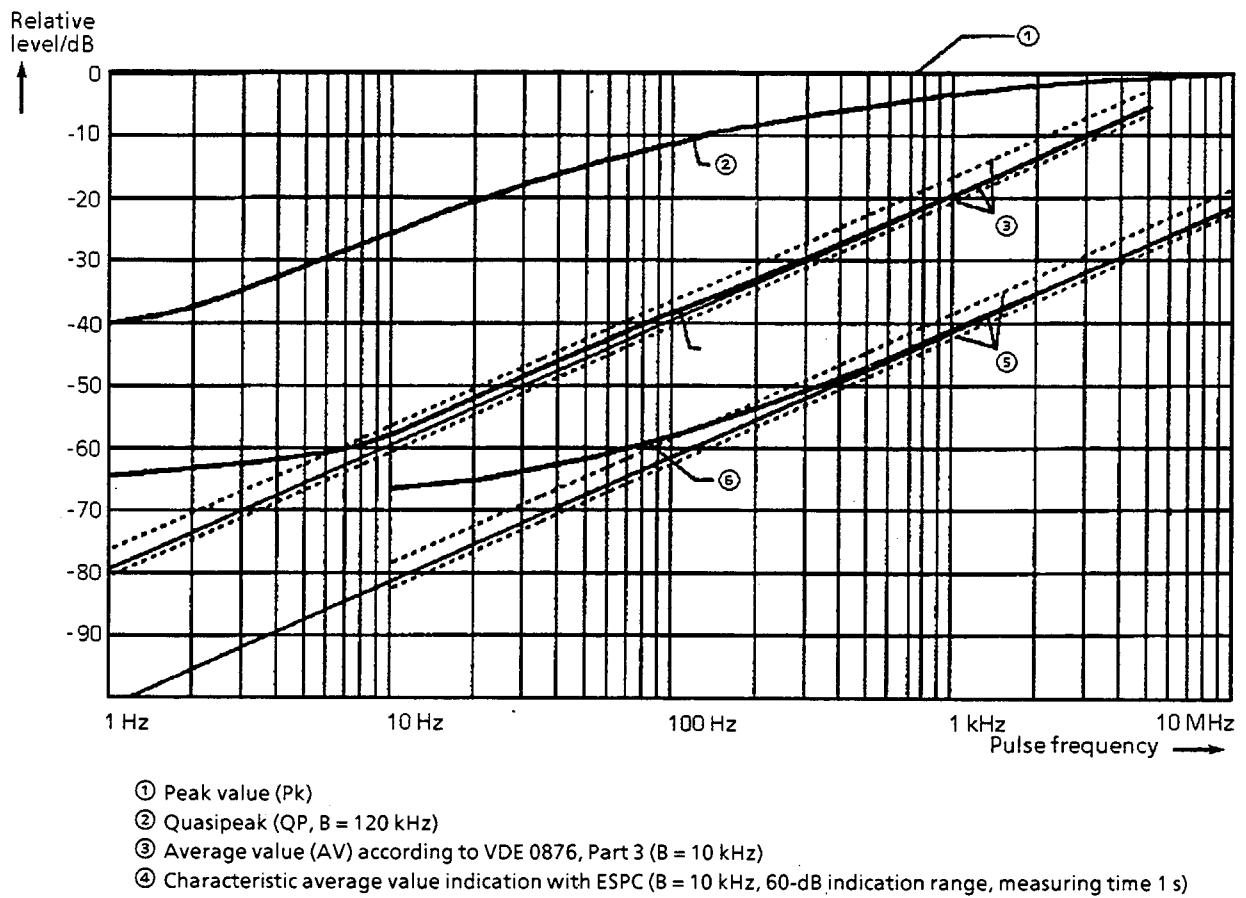
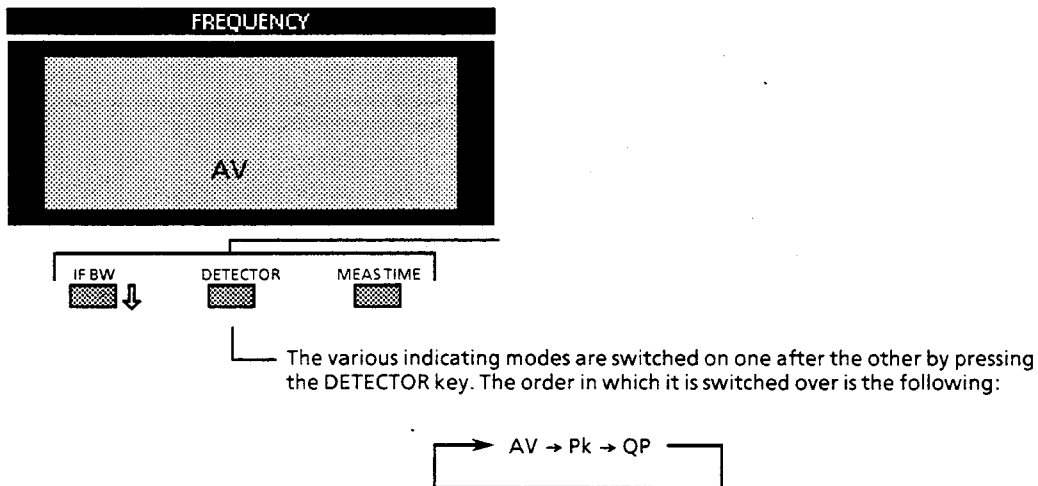

Fig. 3-5 Differences in weighting of pulses between the indicating modes AV, Pk and QP with an IF bandwidth of 10 kHz.

- Sinusoidal signals and pulses with a high repetition frequency result in the same indication in all three weighting modes.
- Peak value indication (Pk) always shows the peak value of the highest pulse independently of the number of pulses during measuring time.

- In quasi-peak mode (QP) level indication drops with decreasing pulse repetition frequency due to time constants specified in CISPR 16.
- Average value indication (AV) weights pulses proportionally to pulse frequency. Level indication decreases most rapidly (20 dB per decade) when pulse frequency is reduced. With the ESPC, the characteristic curve of average value indication (curve ④ and ⑤) is about 1 dB above the theoretical curve, however always within the error limits of +3 and -1 dB, which are agreed upon in VDE 0876 Part 3. The reason is a slight overshoot of the IF filter. Increase in indication for pulse repetition frequencies below 10 Hz is caused by internal receiver noise.

Operation:



3.2.3.9 Selecting the Measuring Time (MEAS TIME)

The measuring time is the time during which the input signal is monitored. The time that is required by the selected detector to settle following a change of attenuation or frequency is not part of it. The measuring time can be chosen within the range of 1 ms to 100 s in the steps 1, 2, 5, 10.

Significance with Peak Measurement:

In indicating mode Pk the maximum value of the level during measuring time is shown. At the beginning of measurement the peak detector is discharged. When the measuring time has elapsed, the output voltage of the detector is A/D-converted and then indicated. With measuring times of over 100 ms the peak voltage is A/D-converted every 100 ms and the maximum value of the individual measurements is taken as measurement value. Unmodulated signals can be measured using the shortest measuring time possible. In the case of pulse signals, measuring time must be set such that at least one pulse occurs during measuring time.

Significance with Average Measurement:

Averaging in indicating mode AV is performed using analog low-pass filters at the output of the linear envelope detector before the logarithmic amplifier. Following a change in frequency or attenuation the receiver therefore waits until the lowpass has settled and then measuring time begins. To keep waiting time as short as possible the receiver monitors the output signal during settling time. If it has already stabilized prior to the end of maximum waiting time, measurement is started earlier. If measurement times of more than 100 ms are selected, the linear output signal of the average value low-pass is also digitally averaged.(linear averaging)

Which measuring time to select depends on the IF bandwidth set and the character of the signal to be measured.

Unmodulated sinusoidal signals and signals with correspondingly high modulation frequencies can be measured using short times. Slowly varying signals or pulse signals require longer measuring times. The following table indicates up to which repetition frequencies pulses as a function of measuring time are still measured correctly (add. error of level indication < 1 dB).

Table 3-5

Measuring time	Min. pulse frequency for correct measurements
1 ms to 20 ms	1 kHz
50 ms to 200 ms	100 Hz
≥ 0.5 s	10 Hz

Thus the shortest measuring time (1 ms) can be used for RFI voltage measurements due to the following reasons: The difference between the limit values for quasipeak and those for average value in the case of RFI voltage measurements amounts to maximally 13 dB (CISPR, publ. 22, instruments of class A). According to figure 3-5 showing the weighting curves this difference occurs at a pulse frequency of 1.8 kHz.

The decisive value for lower pulse frequencies is always the quasipeak limit value. This means that average value indication has to be correct only up to this pulse frequency. As pulses with repetition frequencies of down to 1 kHz can be averaged correctly using a measuring time of 1 ms, it can be applied without reservation for this type of measurement.

Significance with Quasi-peak Measurement:

The relatively long time constants occurring with quasipeak weighting result inevitably in relatively long measuring times that must be set in order to obtain a correct test result. In any case it should amount to not less than 1 second, if the signals to be measured are unknown. A measuring time of that length ensures that pulses with a repetition rate of down to about 5 Hz are correctly weighted.

When switching over attenuation or changing frequency the receiver waits until the measurement voltage has settled and then starts measuring. To reduce waiting time it is monitored whether the signal at the output of the weighting circuit has already stabilized before maximum waiting time has elapsed. If this is the case, measurement is started earlier.

Operation:

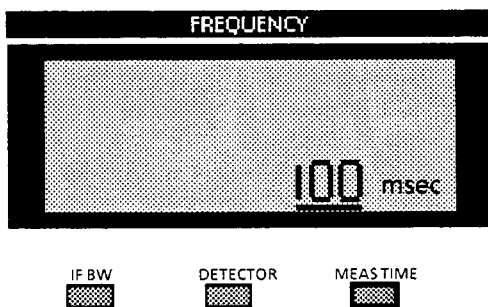

- ▶ Press MEAS TIME key.
To indicate that the measuring time input is active, a bar appears below the display for measuring time.
- ▶ Enter a new measuring time using numeric keypad DATA (cf. section 3.2.2).
- ▶ End input by the desired unit.
The new measuring time is displayed together with the unit.

Note: *Measuring times below 200 ms must be entered in milliseconds; from 200 ms onward seconds must be input as graphical representation is limited to 2^{1/2} positions.*

3.2.3.10 Selecting AF Demodulation (DEMODO)

The ESPC offers two demodulation modes: A3 and A0.

A3 stands for demodulation of AM broadcasting signals. AF bandwidth is limited to 5 kHz. In the indicating mode quasi-peak (QP), noise in the AF-branch is suppressed to some extent in order to show more clearly the devices interfering with pulses. Distortion of signals to which sine-wave modulation has been applied is however higher due to this measure than in other indicating modes.

In the case of A0 a carrier with the frequency of the IF is mixed to the signal on its last IF. If it is an unmodulated signal that is tuned to the receiver centre frequency, zero beat (no audible tone) is the result. When the receiver is detuned, a tone can be heard the frequency of which corresponds to the difference between input signal and receiver frequency. This is helpful when a sinusoidal signal must be discovered in a signal mixture or when the receiver should be tuned exactly to a signal.

Both the volume of the internal loudspeaker and that of the headphones connected to AF OUTPUT socket is set using the rotary knob (15). The loudspeaker is automatically switched off when a PL-55 connector is plugged into the AF OUTPUT socket (e.g. with headphones operation).

Note: When the beeper is activated (cf. section 3.2.3.12), AF-demodulation must be switched on, as otherwise the beeper is not audible. Nevertheless volume control knob may be at the left stop so that the demodulated AF cannot be heard.

Operation:

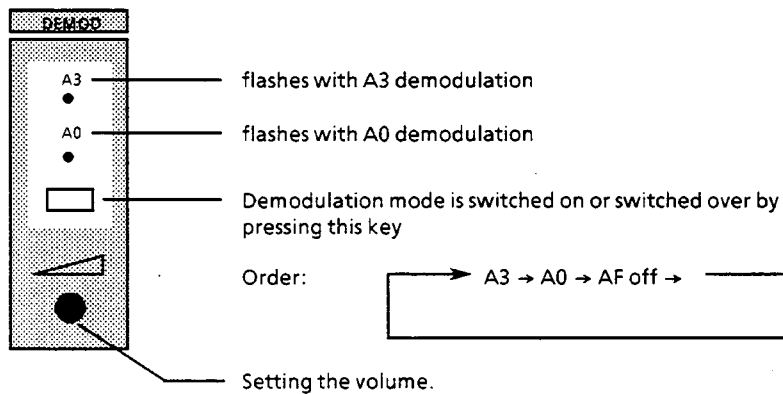

3.2.3.11 Calibration and Measurement Accuracy

The ESPC is calibrated using two internal harmonics generators that generates a 100-kHz spectrum that is flat up to 30 MHz from 10 kHz to 2500 MHz. The entire receiver is calibrated in a complex process.

When performing a calibration the following parameters are recorded and saved in a non-volatile memory:

- frequency response ,
- correction values for the IF-bandwidths ,
- correction values for IF-gain (low noise and low distortion),
- correction values for quasi-peak weighting and
- linearity correction values for the 30-and 60-dB ranges.

Calibration takes about 30 seconds. It eliminates the need for a calibration of the receiver after having switched over a receiver setting. Thus optimal measurement speed is possible while high measurement accuracy is ensured. It is recommended to carry the calibration about 30 minutes after the instrument has warmed up. Due to high stability of the receiver the correction values remain constant for a long time and therefore need not be set anew daily.

Operation:

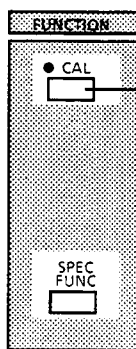

When pressing the CAL key calibration is started. The LED flashes during the calibration process and the remark *CALIBRATION* appears in the DATA INPUT display.

Following completion of calibration, the message *CAL COMPLETE* appears in the DATA INPUT display.

3.2.3.11.1 Error Messages during Calibration

During total and short calibration all correction values recorded are checked whether they are within the tolerances internally specified. If one of the tolerances is exceeded, a warning is output on the DATA INPUT display. The receiver can, however, be further used as it still meets the specifications with only slight reservations. If a function does not work correctly, error (*ERR*) is output. This function can no longer be used. With the beeper switched on (cf. section 3.2.3.12) the attention of the user is directed to these faults by a beeping sound. If several errors occur during calibration, they can be read on the DATA INPUT display by scrolling the screen using the keys of the EDIT keypad after calibration was performed. Error messages are automatically output on a printer connected during calibration. In addition the messages are presented to the user via IEC-bus (cf. section 3.3).

The following warnings and error messages are possible:

ERR: Gain at 1 MHz Gain at the reference frequency 1 MHz cannot be controlled. Calibration is aborted.

<i>WARN: Gain at 1 MHz</i>	Basic gain of the receiver is not within the tolerance limits at the reference frequency 1 MHz. Calibration continues. It is, however, possible that another receiver parameter can no longer be corrected. The user is informed about this occurrence by another error message.
<i>WARN: BW 10 kHz or 200 Hz</i>	Gain at the 200-Hz or 10-kHz IF bandwidth is outside the tolerance limits. Calibration continues. It is, however, possible that another receiver parameter can no longer be corrected. The user is informed about this occurrence by another error message.
<i>ERR: BW 120 kHz</i>	Gain at 120-kHz IF bandwidth can no longer be corrected. Calibration is aborted.
<i>WARN: IF ATT</i>	IF-attenuation correction value is out of tolerance. The IF-attenuation is set in 10-dB steps depending on the operating mode (MODE) and the indicating mode (DETECTOR). If one of these settings exceeds its tolerance limits, correction of total gain of the ESPC may not be possible anymore. A separate error message informs the user about this fault. Calibration continues.
<i>ERR: IF Attenuator</i>	The IF-gain switch is defect so that it is no longer possible to correct its gain error. Nevertheless calibration continues as the ESPC can still be used to a limited extent. When switching on the respective IF-gain, an error message (<i>ERR: IF ATT</i>) is output.
<i>WARN: 30 dB Range WARN: 60 dB Range</i>	Linearity of the test detector is out of tolerance, which results in a slightly reduced total linearity as interpolation must make up for relatively great deviations between the interpolation points. Calibration continues.
<i>ERR: 30 dB Range; or ERR: 60 dB Range</i>	The 30- or 60-dB operating range is defect and can no longer be used. Calibration is aborted.
<i>WARN: Gain at xx MHz/(kHz)</i>	When recording frequency response of the receiver it is noted that the internal tolerance is exceeded. This may have the result that the total correction value may be too high and cannot be set anymore.
<i>ERR: Gain at xx MHz/(kHz)</i>	A filter range of the preselection is defect. Measurements in this range are not possible. When setting this range the error message <i>ERR: Gain</i> is output.
Error Handling during Measurement:	In theory the sum of the individual correction values may exceed the maximum value, although none of the individual values exceeds the tolerances that would lead to an error message. If this is the case, the message <i>ERR: Meas uncal</i> is output on the DATA INPUT display. Illegal measurement values are also shown when output is effected via IEC-bus (cf. section 3.3).

3.2.3.11.2 Measurement Accuracy

When performing a total calibration, all the values determined are related to the internal calibration generator and RF-attenuator. The linearity of the operating ranges is recorded in 10-dB steps. It is interpolated between the interpolation points. Due to the high linearity of the envelope detector and logarithmic amplifier (typ. error < 0.15 dB), the interpolation points are sufficient for an optimal correction. The measurement value is internally (by the instrument itself) determined in $1/100$ dB so that rounding errors are not of significance.

The error limits are composed of:

Error limits of attenuator:	0.7 dB
Error limits of calibration generator:	0.4 dB
Setting accuracy of gain:	0.05 dB
Nonlinearity of envelope detector:	0.05 dB

On the basis of these values a measurement error of maximally 1,2 dB results for the entire measurable level range. Since the errors do not depend on each other in terms of statistics, quadratic addition of the individual errors is permitted to determine the total error. It is thus 0.9 dB over the entire operating temperature range. In practice measuring accuracy is considerably higher for signals with sufficiently high signal-to-noise ratio.

An additional measurement error, which is determined by physics, is due to the inherent noise of the receiver. The error is least significant with average value indication; with peak value indication, however, it is considerably higher. In indicating mode quasi-peak the error strongly depends on the type of signal to be measured.

In the case of average and peak value the error as a result of the signal-to-noise ratio can be determined approximately using the following formulas:

$$\text{Average value: } = \text{error/dB} \approx 20 \log \left(1 + 0.3 \times \frac{N_1}{S} \right)$$

$$\text{Peak value: } = \text{error/dB} \approx 20 \log \left(1 + 0.8 \times \frac{N_2}{S} \right)$$

S = level of an unmodulated signal in μV ,

N_1 = Noise indication with average value (AV) in μV

N_2 = Noise indication with peak value (Pk) in μV

$N_2 \approx N_1 + 11$ dB.

Table 3-6 and figure 3-6 illustrate increase in indication in the case of average value measurement of sinusoidal signals and peak value measurement as a function of the signal-to noise ratio.

Table 3-6: Error occurring when measuring an unmodulated sinusoidal signal with average or peak value indication as a function of the signal-to-noise ratio.

Signal-to-noise ratio	Increase in indication in dB with	
	Average value (AV)	Peak value (Pk)
0	2.28	5.10
1	1.86	4.67
2	1.50	4.27
3	1.21	3.98
4	0.98	3.54
5	0.79	3.22
6	0.63	2.92
7	0.50	2.65
8	0.40	2.39
9	0.32	2.16
10	0.26	1.95
12	0.16	1.59
14	0.10	1.28
16	0.06	1.03
18	0.04	0.83
20	0.02	0.67
25	0.01	0.38
30		0.22
40		0.07
50		0.02

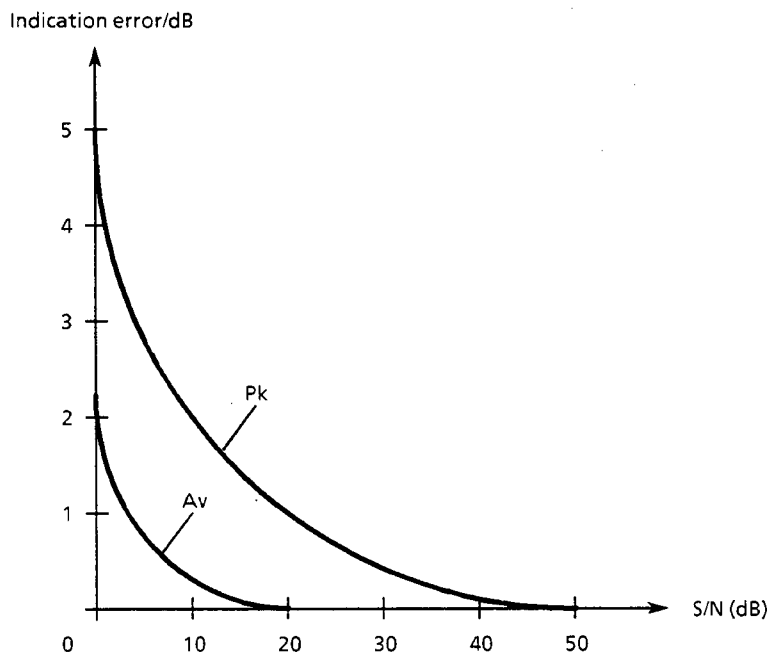

Fig. 3-6 Increase in indication of an unmodulated sinusoidal signal as a result of noise as a function of the signal-to-noise ratio.

Fig. 3-7 illustrates the increase in indication as a result of receiver-internal noise with quasi-peak indication (Band B) for sinusoidal signals and pulse signals with a pulse repetition frequency of 100 Hz. Due to pulse weighting the error strongly depends on the type of input signal. In the case of sinusoidal signals the increase in indication is almost as high as with peak value indication. With pulses the indication error due to noise is reduced with decreasing pulse frequency.

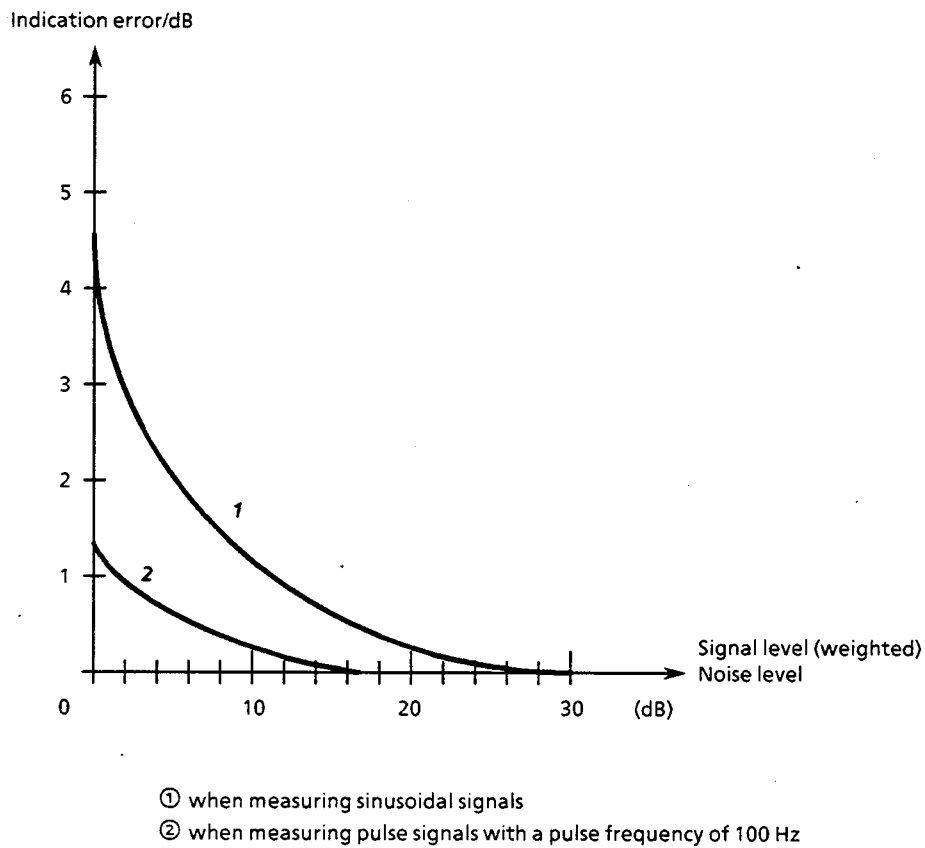

Fig. 3-7 Indication error due to noise with quasi-peak indication

For measurements carried out in practice the following can be recommended:

- To make full use of the accuracy of the ESPC, carry out measurements with a high signal-to-noise ratio, i.e. 60-dB range, low noise.
- When measuring sinusoidal signals use average value indication as it is the least sensitive to the signal-to-noise ratio.
- Carry out quasi-peak measurements using low noise, if the type of input signal permits this mode (cf. section 3.2.3.3, Selecting the Operating Mode). In autorange operation the receiver, itself takes it into account.

3.2.3.12 Special Functions (SPEC FUNC)

Special functions are integrated into the ESPC for applications requiring special properties of the receiver. The user, himself, can select - to a certain extent - the properties of the receiver using these special functions.

Each special function has a number so that it can be easily addressed. To arrange them even more clearly they are divided into groups, each beginning with a new tens place.

Table 3-7

Special function groups	Call
Test parameters	SPEC FUNC 01, 02
Switch functions	SPEC FUNC 10, 11, 12, 13, 16, 17, 18
Output of measured values	SPEC FUNC 20,
Special measurement modes	SPEC FUNC 30, 32, 33,
Trigger functions	SPEC FUNC 51, 52

Operation:

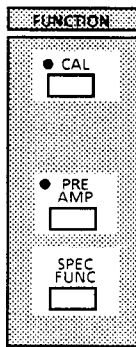

- ▶ Press SPEC FUNC key.
In the DATA INPUT display the SPECIAL FUNCTION menu appears:

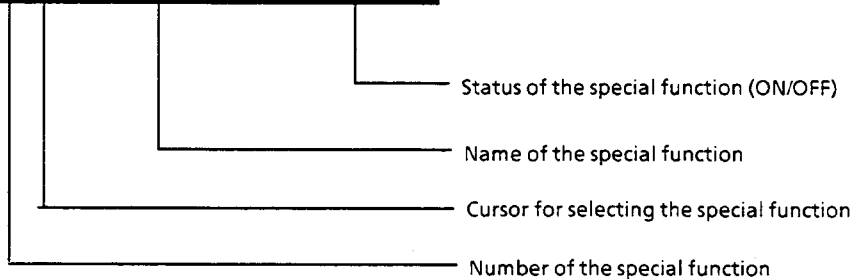
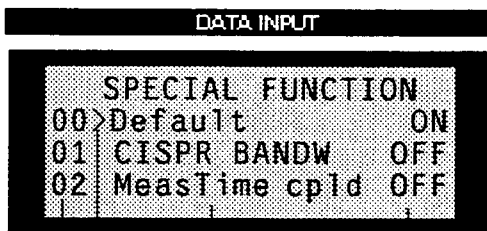

Each menu features three special functions. The cursor is positioned on the desired function using the ↑ and ↓ keys available in the EDIT keypad. The menu can be scrolled to have access to special functions that are not displayed at the moment.

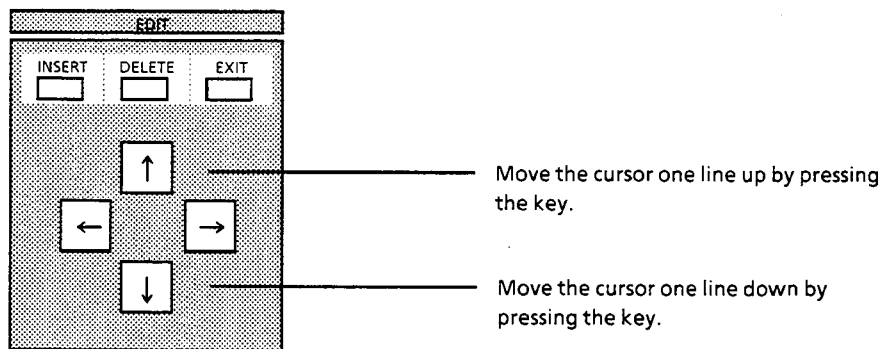

A special function can be selected more rapidly by entering the respective number. In this case the cursor moves directly to the desired special function.

The status of the special function is switched over (ON → OFF, OFF → ON) by pressing one of the ENTER keys. The cursor remains on the selected function after switch-over. This means that the special function is switched on or off by pressing the ENTER key.

Some special functions call submenus in which numeric data must be input. Following the entry of the respective data the SPECIAL FUNCTION menu with the modified status of the selected function is displayed again.

Explanations to the Various Special Functions:

SPEC FUNC 00 Default

Any special function assumes its default setting using the special function *00 Default*.

SPEC FUNC 01 CISPR BW

Default setting is OFF.
With *CISPR BW ON* the bandwidths specified for the indicating mode quasi-peak are switched on not only in this mode but also in average and peak value indicating mode depending on the receiver frequency (cf. section 3.2.3.8.4).

SPEC FUNC 02 MeasTime Cpld Default setting is ON.

With default setting measuring time is coupled with the IF-bandwidth, thus ensuring that the signal can settle. Under certain conditions it may be sensible to annul this connection. Example: A sinusoidal signal is measured with fixed receiver frequency setting.

SPEC FUNC 03 Min ATT 10 dB

Default setting is ON.

With this function the minimum RF attenuation set in the autorange mode and after instrument switch-on can be configured. The minimum RF attenuation of 10 dB set after instrument switch-on and in the autorange mode to protect the input mixer (see section 3.2.3.4) can be disabled with OFF when an external pulse limiter is used or in the case of RFI fieldstrength measurements. If the receiver is switched off with 0-dB attenuation set, this value is reset when the receiver is switched on again. In this case 0-dB attenuation can also be set when the scan option 01, RFI Voltage ON (see section 3.4.1) is selected.

- SPEC FUNC 10 Display Light* When operating with internal battery, default setting is OFF, otherwise ON.
To increase operating time when using internal battery, illumination of the LC displays is switched off. The receiver, itself recognizes by which source it is fed and switches lighting correspondingly. When operating under poor lighting conditions, it is however recommended to switch on illumination.
- SPEC FUNC 11 IEC 625* When operating with internal battery, default setting is OFF, otherwise ON.
IEC-bus operation is usually not desired when operating with internal battery, as the required controller usually must be mains-operated. The IEC-bus is therefore switched off to increase operating time. The receiver, itself recognizes by which source it is fed and selects the status of the IEC-bus correspondingly.
During plotting the IEC bus cannot be switched off.
- SPEC FUNC 12 Antenna Code* Default setting is ON.
Active transducers from Rohde & Schwarz, such as the loop antenna HFH2-Z2 or the rod antenna HFH2-Z1 or HFH2-Z6 are supplied by the socket ANTENNA CODE. At the same time the conversion factor of the transducer is coded using this socket. If coding of the conversion factor is not desired because e.g. an additional test cable is used, it can be switched off using this special function. The individual conversion factor can then be input via the transducer factor (cf. section 3.2.4.2.1). Coding at the ANTENNA CODE socket is then always ineffective regardless of the setting of the special function.
- SPEC FUNC 13 Beeper* Default setting is OFF.
The ESPC contains an internal beeper, which draws the attention of the user to various states of the instrument. In the following cases a beeping sound can be heard:
- end of a frequency scan,
 - end of a plotting process,
 - end of a printing process,
 - Output of an error message or warning and
- It is however required that the AF is switched on. The loudness of the beeping sound is independent of the volume setting, i.e. if the demodulated AF-signal is not desired, volume control can be turned completely down.
- SPEC FUNC 16 Check Limit* Default setting is OFF.
This function is only effective in receiver mode (not in scan mode)
When a limit line is active, each measured value is compared with the limit value provided that the special function is switched on. When the value is higher than the limit, the message *Limit exceeded* is output on the DATA INPUT display. If the value is below the limit value, the message disappears again. With the beeper being switched on (*Spec Func 13*), a beeping sound is audible when the limit value is exceeded during the first measurement on a new frequency.
- If a double test mode is switched on in receiver mode (special functions 30 to 33), the message indicating that a limit value was exceeded appears when at least one of the two measurement values exceeds its associated limit value. Chapter 3.2.4.3.2 describes how to assign measurement detectors to limit values. In standards, limit values for peak or quasipeak are always higher than that for average.

SPEC FUNC 17 Check Transd Default setting is OFF.
With special function 17 switched on, the transducer value (with unit) that has been calculated from the set receiver frequency is indicated instead of the measurement value on the LEVEL display. In this case, the level is not measured. In the LEVEL display there is no indication of ZERO SCALE DEFLECTION, ATTENUATION and MODE and in the FREQUENCY display bandwidth, detector and measuring time are not shown when outputting transducers. The activated transducer can thus be checked manually by detuning the receiver frequency. The transducer can also be output graphically on plotter or printer. The axes for level and frequency are determined by the values defined in the scan data set (cf. section 3.2.4.3.1). Output is initiated by pressing the PLOT or PRINT key (cf. section 3.2.4.4).

SPEC FUNC 18 Transducerswitch Default setting is OFF.
A port of the USER INTERFACE at the rear panel of the ESPC can be set using special function 18 in combination with an active transducer set. A single port (5-V logic level) is assigned to each transducer range. The number of the active port corresponds with that of the range valid for the current receiver frequency, i.e. port 1 (pin 14) is active in transducer range 1. There is no active port when the receiver frequency is outside the defined transducer set. This function is useful for switching different antennae by way of an antenna matrix during a scan or with manual frequency variation.

Special function 18 is ignored with the scan option 01 RFI Voltage being.

The message *Change Transducer* is suppressed when using special function 18

SPEC FUNC 20 Unit dBm Default setting is OFF.
The unit dBm is used for the power level at 50 Ω. The ESPC is, however, not an r.m.s. value meter. The voltage indicated in the selected indicating mode together with the rated input resistance of 50 Ω are only converted into the respective power level. Solely the power of a signal that has not been amplitude-modulated is correctly indicated.

As the unit can only be used for power levels related to 1 mW, the special function is only effective when no unit is coded at the ANTENNA CODE socket. The unit is also only active with transducer factors having the unit dB, i.e. only four-terminal networks with specified power attenuation or power gain can be taken into account.

When coding a unit at the ANTENNA CODE socket or entering a unit other than dB in the transducer factor, the unit dBm becomes ineffective and the selected unit is displayed.

SPEC FUNC 30: Pk + AV
SPEC FUNC 32: Pk + QP
SPEC FUNC 33: QP + AV Default setting is OFF.
These are combined test modes; during the measurement two different detectors are simultaneously switched on. If one of these special functions is activated, both active detectors are shown in the display for the detectors. Thus it is for example possible to detect broadband interference by means of the peak value detector and narrow-band interference by way of the average value detector at the same time. In the case of an automatic frequency scan only one scan is required. As only one measured value at one time can be indicated on the level display, these functions are only active in remote control, i.e. both values are output via IEC-bus. During a frequency scan in manual mode both

values are measured and stored for plotter or printer output; it is however only possible to indicate every first value (example: Pk + AV → Pk is indicated). When outputting the test curve on a plotter during the scan (option "Meas. & Plot, cf. section 3.2.4.3.3) the curve for the first indicating mode is immediately displayed, the second test curve is displayed subsequently (example: QP + AV → the QP-curve is plotted during measurement and then the AV-curve). Only one of the double measurement modes can be active at one time. When switching on a new function, the one that has already been activated is automatically switched off.

SPEC FUNC 51: Ext Trigger +

Default setting is OFF.

The ESPC starts a measurement with a positive signal edge (TTL level) applied to the USER INTERFACE (Pos 28, fig. 3-2), connector pin assignment, cf. section 3.2.6.5. This is useful, if for example a test item produces interference at a certain time and a suitable trigger pulse can be derived from the test item. It makes sense to set optimum attenuation of the ESPC prior to the measurement, if there is not enough time for autoranging.

SPEC FUNC 52: Ext Trigger -

Default setting is OFF.

The ESPC starts a measurement with a negative signal edge (TTL level) present at the USER INTERFACE (28), connector pin assignment cf. section 3.2.6.5. It is useful to set optimally the attenuation of the ESPC prior to the measurement, if the time for autoranging is not sufficient. The special function is automatically deactivated when the special function SPEC FUNC 51 are switched on.

3.2.4 Operation of the Menu Functions

The hardkeys of the keypad MENU are provided for presetting instrument parameters, controlling complex processes, entering limit lines and transducer factors, outputting measurement results and calling instrument self-tests. The keys can be used for calling a menu in the display DATA INPUT, which makes various submenus accessible, if required.

3.2.4.1 Input and Editing in the Display DATA INPUT

3.2.4.1.1 Editing the Menus

The display DATA INPUT is an alphanumeric LC-display with 4 lines featuring 20 characters each. The first line contains the designation of the menu currently active. The remaining three lines consist of the individual menu points. In some menus there is not enough space to display the list of selectable menu points. Every menu point becomes visible by scrolling the list upward or downward using the respective cursors.

A menu point can be selected using the ↑ and ↓ keys in the operator keypad EDIT. Selecting is performed by placing the cursor "}" on the desired menu or in the case of a table on the respective line and then pressing ENTER or → to call the menu; when it is necessary to input a value, it can be entered using the numeric keypad. When e.g. values are entered into a table, a character can be inserted or deleted at the position of the cursor is placed using INSERT or DELETE.

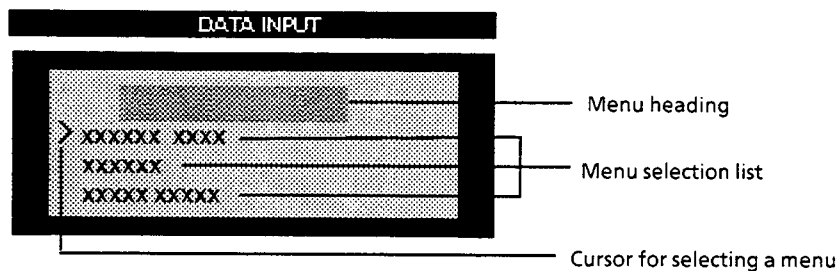

Further entries in the menu selection list can be accessed by way of scrolling the display DATA INPUT

Fig. 3-8 Architecture of the display DATA INPUT

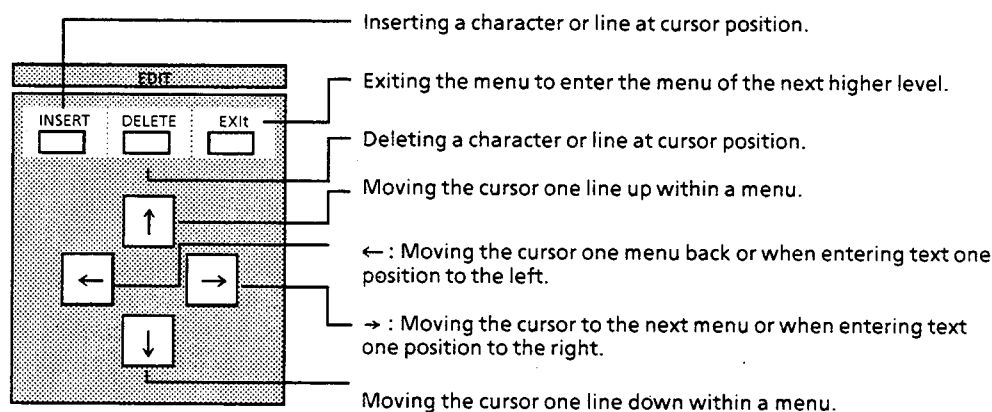

Fig. 3-9

3.2.4.1.2 Input of Texts and Labellings

Transducer factors, limit lines and protocols output on plotter or printer can be given names or labelled by the user. The name or labelling can either be entered via the keyboard that can be connected to the rear panel (cf. section 3.2.6.8) or via auxiliary line editor in the third and fourth line of the display DATA INPUT, if there is no keyboard available.

The receiver recognizes automatically whether a keyboard is connected and if so, the auxiliary line editor is not offered for application. Due to the considerably more convenient way of input a keyboard is recommended to be used especially when labelling test protocols.

Operation of the Auxiliary Line Editor:

When using the auxiliary line editor upper-case letters and punctuation marks are displayed in the third line of the display DATA INPUT, lower-case letters and figures in the fourth line. As the space available is not sufficient, the characters not displayed can be made visible by scrolling to the left or right using the cursor keys of the EDIT keypad.

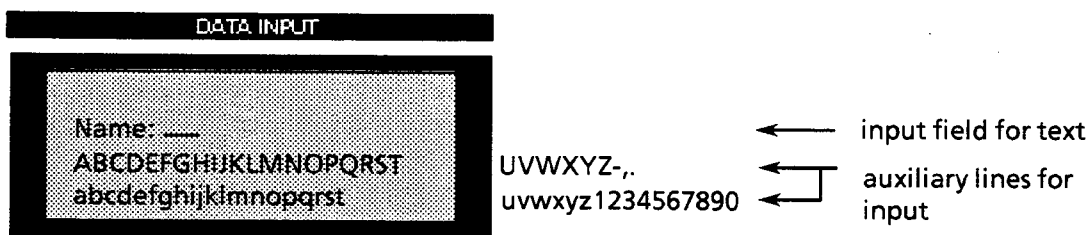

Fig. 3-10

The character desired for labelling is selected using the cursor keys via an auxiliary cursor and inserted at the position of the main cursor () by way of INSERT. The character then appears at the position of the main cursor. The latter moves automatically one position to the right. The respective character that is to the left of the main cursor can be deleted using the DELETE key. Input is terminated by ENTER. The auxiliary line editor then disappears automatically.

3.2.4.2 Configuration of the Receiver (Keypad INSTR STATE)

The presettings

- input of date and time,
- selection of the IEC-bus address (IEC 625),
- display of the firmware version and
- operation with external reference

are indicated or can be newly entered in the SETUP menu.

Operation is described in section 2.1.5.

3.2.4.2.1 Entering and Calling of Transducer Factors (TRANSDUCER Menu)

When carrying out interference measurements a coupling network, which converts the interfering quantity to be measured into a voltage at 50 Ω, is usually connected ahead of the receiver. Coupling networks may be antennas, artificial mains networks, probes or current probes. They often feature a non-decadic conversion factor which is also frequency-dependent. Transducers with a non-frequency-dependent conversion factor can be coded in 10-dB steps at the ANTENNA CODE connector (cf. section 3.2.5.1). Non-decadic conversion factors must be considered in the transducer factor. The receiver indicates the quantity to be measured that is present at the input of the coupling network, if the transducer is activated.

In the case of the ESPC a distinction is made between **transducer factor**, in the following text abbreviated by "factor", and **transducer set**, briefly "set". A factor consists of points, which are defined by frequency and conversion factor, and the unit that determines the unit of the level display. For frequencies between the known points the transducer factor is approximated using modified spline interpolation.

The unit of the transducer applies to the entire frequency range of the receiver, even if the transducer only covers a part of the range. Outside of the definition range it is assumed that the conversion factor is 0 dB. The receiver therefore delivers illegal measurement values, if the receiver frequencies exceed the transducer definition range. This is indicated by the hint *Warn: Transd undef* in the display DATA INPUT. Moreover, in practice it is futile to use a transducer for measurements in a frequency range in which the transducer can actually not be used.

Up to 22 different factors can be defined and stored permanently. They are provided with a number (1 to 22) and a name that can be specified by the user so that they can be told from each other.

Since in practice the required number of points for the various coupling networks varies, the maximally possible number of values depending on the number of the transducer is grouped according to the following table:

Table 3-8

Transducer number	Number of points
1 to 10	10
11 to 20	20
21, 22	50

These 22 factors can be combined to form sets. Maximally 5 sets are possible. A prerequisite is that all factors combined have either the same unit or the unit "dB". The definition range of a set is divided in turn into ranges. Various factors can be activated per individual range. There may be no gaps between the individual ranges, i.e. the stop frequency of a range must be equal to the start frequency of the following range.

The definition range of the transducer factors used in a certain range must cover it completely.

It is recommended to define a transducer set when different coupling networks are used in the frequency range to be measured or when cable attenuation or an amplifier are also to be considered.

If a transducer set is defined, a frequency scan is stopped at the intersection between two ranges and the user is requested to change the coupling network (transducer). The following request appears on the display DATA INPUT:

"Connect <Transducer Name>."

If the beeper is activated (special function 13), a short beeping sound can be heard.

The rules according to which the transducer factors can be combined to form sets are summarized with the help of the following examples. The rules are implemented in the ESHS so that the user need not care whether the transducer set entered is valid.

a) Only one single transducer factor is active:

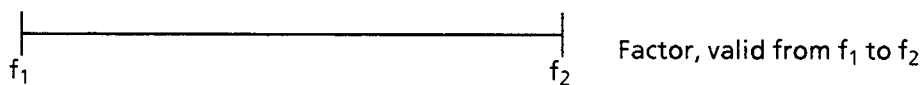

b) Transducer set with several factors lined up in a row:

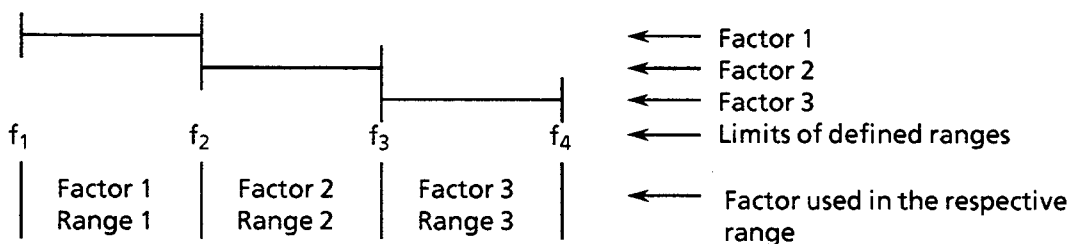

The set is valid from f_1 to f_4 . The units of the individual factors are the same. There are no gaps between the individual ranges.

c) Transducer set with several overlapping factors:

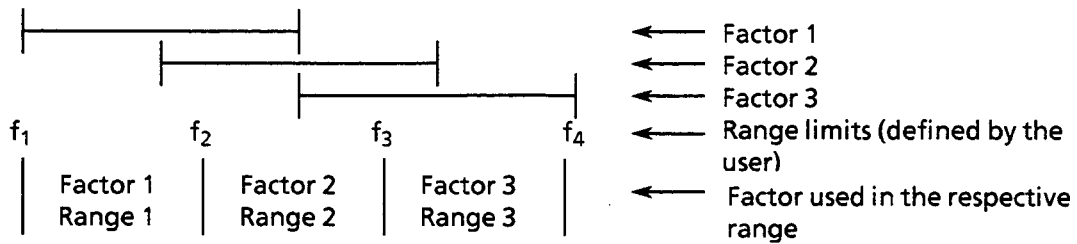

With overlapping factors only those factors that cover a range completely can be activated in it. This applies for f_1 to f_4 with the above-mentioned ranges.

d) Several factors are simultaneously valid:
(set of transducers from f_1 to f_3)

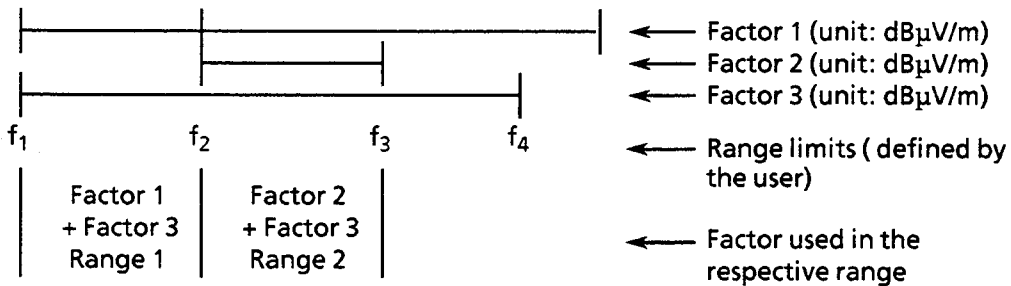

Two factors can be activated simultaneously, when the unit of one factor is dB or when both factors have the same unit. The factor 3 is added to factor 2 or factor 1 in their valid range.

Operation:

Input and editing of transducer factors and sets is called using the TRANSD key (in the keypad INSTR STATE).

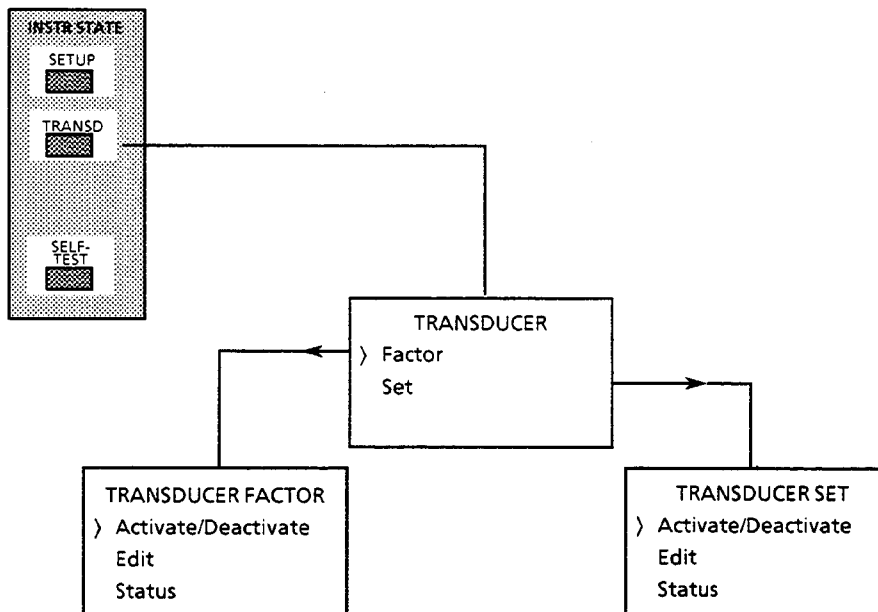

Fig. 3-13 Flowchart for calling the transducer factor

The first few submenus are the same for editing a factor and a set. Here, a factor or a set can be activated (*Activate*) or deactivated (*Deactivate*), changed or newly entered (*Edit*) and the current status can be indicated (*Status*).

Input or Editing of a Transducer Factor:

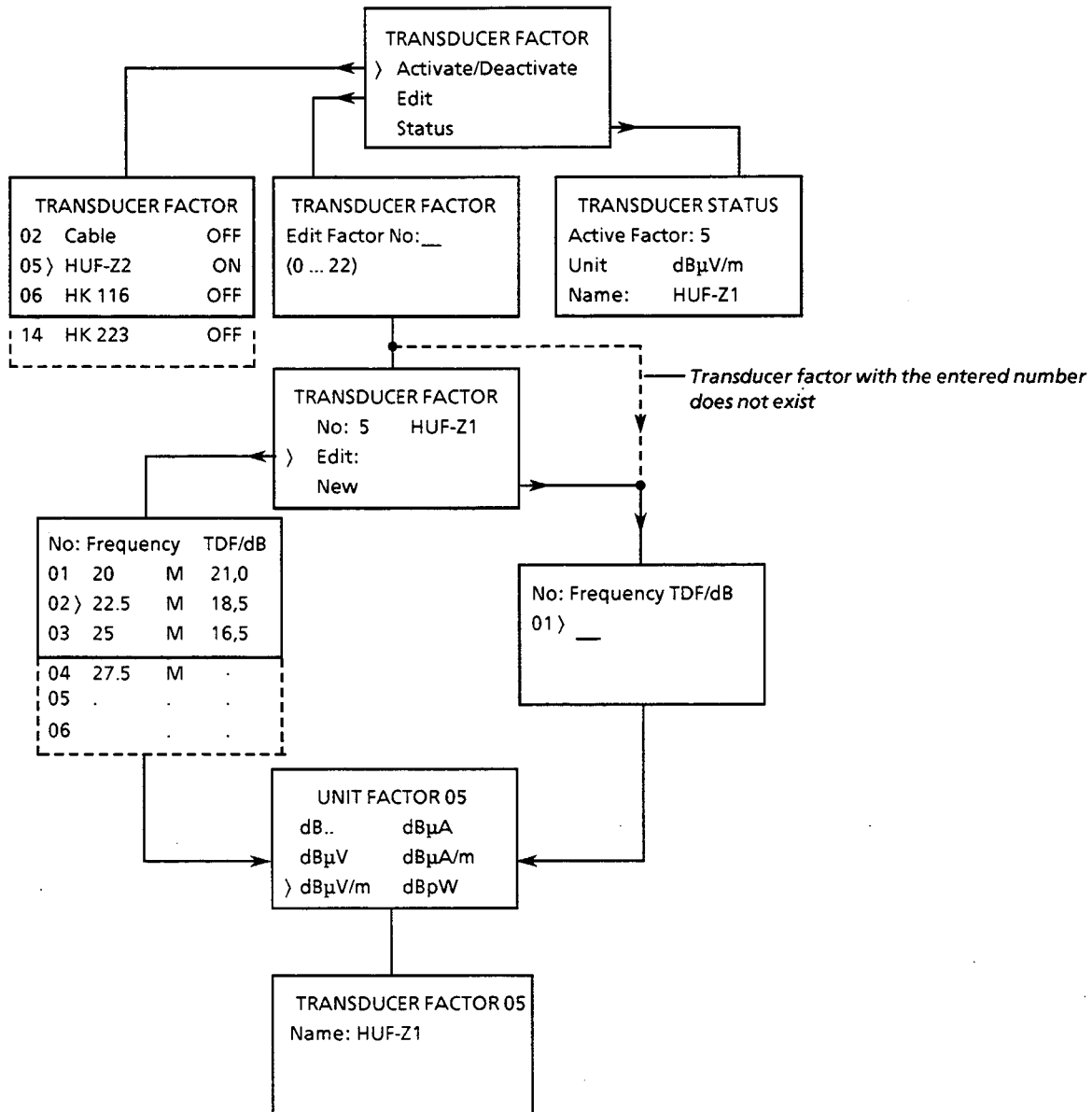

Fig. 3-14 Flowchart for entering or editing a transducer factor

Activate/Deactivate:

In this menu a stored factor is activated or an active factor is deactivated. If a factor is active, the menu point is referred to as *Activate/Deactivate*; if there is no active factor, the name is only *Activate*. After having selected the menu point, a submenu, in which all defined transducer factors with their numbers, names and current status are listed, is called. If no transducer has been defined, the message "None defined" appears in the DATA INPUT display. The cursor is placed on the active factor or, if there is no active one, on the factor with the lowest number. The cursor is placed on the factor to be activated using the ↓ and ↑ keys or by entering the appertaining two-digit number (e.g. "01" must be entered for factor 1). If the factor with the number entered is not defined, the error message "<xx> undef" (<xx> = number entered) appears in the last display line.

The status of the factor is changed by pressing the ENTER key (ON → OFF, OFF → ON). As only one factor or set can be active at one time, an already active factor or set is automatically deactivated, when switching on a factor or set. The menu is exited using the ← key or EXIT.

Transducer Status:

In the menu Transducer Status the current status of the receiver is displayed. In the second line the factor currently active is shown. If a transducer set is active, it is also displayed. If neither any factor nor any set is used, *none* appears in the menu. In the third line the unit and in the fourth line the name of the factor or set used is displayed.

Edit Factor:

In the Edit menu the desired factor for editing is first asked for. This factor must be entered together with its number. If the factor with the number selected does not yet exist, the blank table appears for entering the points. Otherwise, the name of the factor is represented in the following menu and the choice between editing of the factor (*Edit*) and new entry of the factor (*New*) is offered. The factor to be edited is subsequently represented in a table. If new entry has been selected, the table is blank.

**New Entry of
Transducer Factors:**

New entry of factors must be performed in the sequence of increasing frequencies and must be input with frequency and transducer value. The cursor is initially placed on the frequency of the first point. Following frequency input (terminated by MHz) the cursor jumps automatically on the appertaining transducer value.

Values of -200 to +200 are permissible for the transducer. When entering a transducer factor that is higher than 200 dB or lower than -200 dB, the message "*Max Level 200 dB*" or "*Min Level -200 dB*" respectively is read out in the fourth line of the display DATA INPUT. **Amplifiers have a negative conversion factor, attenuation values must be entered as a positive conversion factor.** After having completely entered the point the next one is automatically selected.

If the increasing order is not kept, the error message "*Freq Sequence!*" is output and frequency input is ignored, i.e. the entry is not accepted and the space remains blank after having terminated the input, thus being available for a new input. If a frequency that cannot be set in the receiver is entered, the error message "*Max Freq 1000 MHz*" is output in the fourth line when the frequency is too high. When entering a too low frequency, the message "*Min Freq 20 MHz*" is output. Points that have been already present are changed by selecting them using the cursor and then entering a new value.

If the maximum number of points has been entered, the input menu is automatically exited. It can, however, already be exited by pressing the ENTER key while the cursor is in a blank frequency field or by means of the → key. The following submenu subsequently offers a number of units that are possible for the newly entered factor. The desired unit is selected by placing the cursor on it using the ↑ and ↓ keys and pressing ENTER.

The factor can finally be given a name (*Name*). Input can either be performed via the external keyboard or via the auxiliary lines for text input (cf. section 3.2.4.1.2), if the keyboard is not connected. Maximal eight characters are permissible for the name. If no name is desired, the field *Name* can be kept blank. Definition of the transducer factor is complete, when having pressed ENTER after input of the name.

Editing of Already Existing Transducer Factors:

While editing a transducer factor a point can be deleted, a new one can be inserted or only a frequency or a transducer value can be changed. Inserting or deleting is possible, when the cursor points to the number of the point. The respective point is deleted using the DELETE key and all the subsequent values move up. A blank line is created at the position of the cursor using INSERT and all following points are raised by one number.

When entering the new frequency in the new line it must be ensured that the frequency order is kept to as otherwise input is not accepted. In this case the error message "*Freq Sequence!*" appears in the last menu line. If the transducer factor has already the maximum possible number of points, it is no longer possible to insert a new one. When trying nevertheless, the error message "*Max <xx> values*" appears in the lowest line (<xx>: the maximum number of points depending on the number of transducer factor, cf. table 3-8).

A frequency or a transducer value can be changed when placing the cursor on the desired number. When entering a figure the old frequency is deleted and the new one is displayed. Stick to the increasing frequency sequence in this case, too. When pressing ENTER without having entered a number before, the cursor jumps to the factor value that can then be input anew.

The EDIT menu is exited either by way of the → key or, when the cursor is on the last point by pressing ENTER. The menu for the unit appears (cf. new entry of transducer factors).

Generating or Editing a Transducer Set:

The structure of menus for editing a transducer set is similar to that of a factor. *Activate/Deactivate* and *Status* lead to submenus in which only factor is replaced by set. Operation and function are analog to that of the transducer factor. Only EDIT menus differ from those of the transducer factor.



Bild 3-15 Flowchart for generating/editing a transducer set

Edit:

In the EDIT menu the set that is to be edited is first asked for. The desired set must be entered together with its appertaining number. If no set with the selected number exists, the blank table for entering points appears. Otherwise the name of the set is displayed in the following menu and the user can chose between editing the set (*Edit*) and entering a new set (*New*). With sets that do not yet exist only new entry is permitted.

New Entry of Transducer Sets:

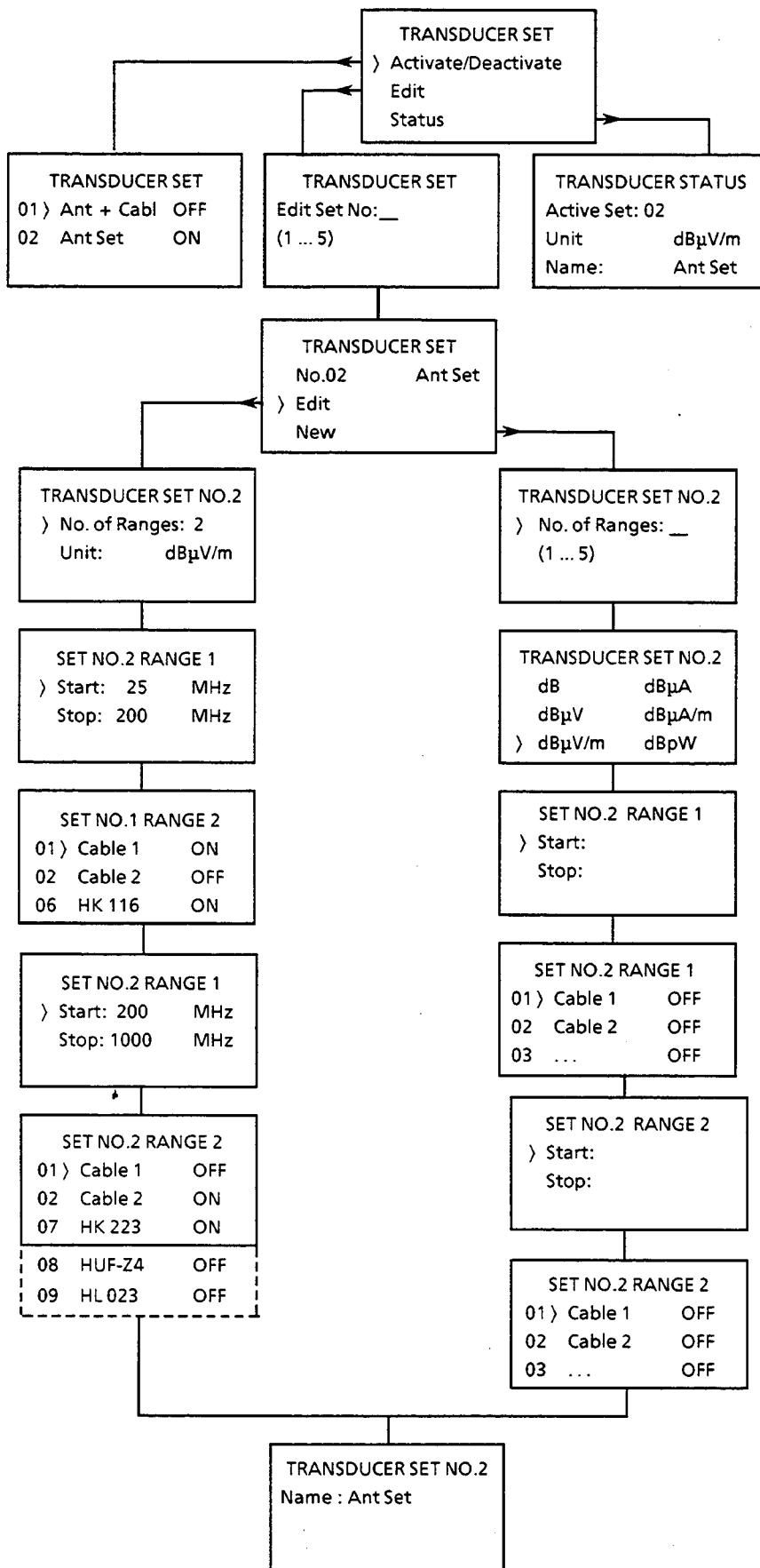
When entering transducer sets for the first time, the number of ranges which the transducer set comprises is requested in a menu. Up to five ranges are possible. With the entry of the desired number the next menu appears, in which the unit of the set is specified. The unit is selected by the cursor via the ↑ and ↓ keys and input using ENTER.

The frequency limits of the individual ranges for the set and the factors active in the range are subsequently input one after the other starting with range 1. As there may not be any gaps between the individual ranges, the start frequency is already pre-determined from the second range (stop frequency of the preceding range).

In the list from which the factors can be selected for the range currently to be edited ***only those factors that are matched to the unit of the set and are defined over the entire individual range*** are available. These factors are indicated in the status Off. The desired factors are selected by the cursor and their status is switched over using ENTER (OFF → ON). The menu is exited using the → key. If no factor has been activated in a range, the transducer in this range will be set to 0 dB. The unit is the one defined for the entire set.

After having entered all ranges the set can be provided with a name (*Name*). Input is possible either by the external keyboard or by the auxiliary lines for text input (cf. section 3.2.4.1.2), if the keyboard is not connected. The name may consist of maximally 8 characters. If no name is desired, the field may remain blank (merely pressing ENTER).

Editing of Already Existing Transducer Sets:

When editing a transducer set the number of the ranges (*No of Ranges*) and the unit (*Unit*) of the set appear in the menu. The number of ranges may be altered, the unit however not as this would correspond to a new entry. It is possible to move from one point to the other within each individual range using the ↑ or ↓ keys. The cursor can be moved from menu to menu using the → or ← keys. The individual menus have the same structure as those for new entry. Start and stop frequencies of the individual ranges can be changed by selecting the corresponding menu point and directly entering new values.

When pressing the ENTER key the old value is retained and the cursor jumps to the next line. When changing the stop frequency the start frequency of the next range is also automatically changed. In the case of the ranges 2 to 5 the start frequency cannot be changed as there may not be any gaps between the individual ranges. The status of the factors that are possible in the various ranges is switched over in the same way as with new entry.

Note: *When the frequency limits of the individual ranges are changed, it may occur that transducer factors that used to be active in a range are no longer permissible as their definition ranges do not cover the range. These factors do no longer appear in the selection list. After having edited the last defined range it is possible to change the name of the set (cf. new entry).*

3.2.4.2.2 Calling the Self Test (SELF TEST Menu)

The ESPC is equipped with a wide variety of self-test functions that can detect an instrument error even if it is on module level. The self-test runs independently while the functions that build up on one another are tested in turns starting from the lowest function level. When a faulty function is detected, it is indicated on the DATA INPUT display with a hint to the respective module (*ERR: <Module>*). Only one error can be detected as the following tests cannot be carried out correctly, if there was a faulty function. To avoid unfounded error messages the self-test is aborted following the detection of the first error. Complete instrument settings can be called to allow for convenient setting of the modules in the case of replacement.

The run of the self-test, possible error messages and replacement of modules are described in detail in section 4.

Operation:

The self-test menu is entered by way of the SELFTEST key in the keypad INSTR STATE. The desired function is called either by entering the appertaining number of by way of the cursor. The status of the calibration generator (*CAL Gen*) and of the calibration correction values is switched over. When exiting the menu by means of EXIT, the default operating status is automatically re-established (cf. menu).

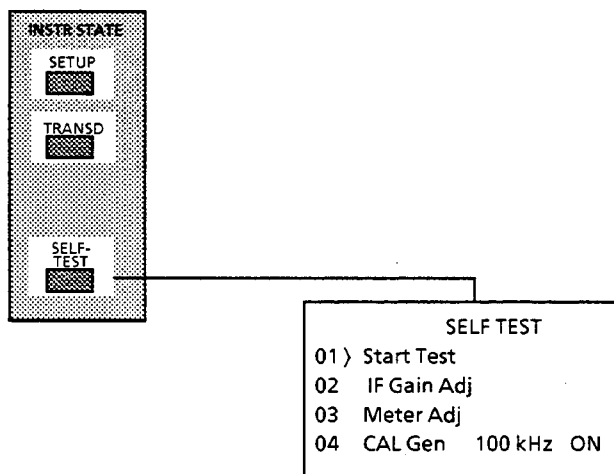

Fig. 3-16 Calling the SELF TEST menu

3.2.4.3 Execution of Frequency Scans (Keypad ANALYSIS)

For measuring interference spectra the most important feature of the ESPC is that it is able to perform independent frequency scans with setting data varying from range to range. A test report can be output in the form of a diagram and/or a table either by means of a printer or a plotter or using both. Limit lines can be defined in accordance with the rules specified for the respective measurement and also be output. The frequency scan can be adapted to the specific measurement problem with the help of various analysis options (*Options*)

3.2.4.3.1 Generation and Editing of Data for a Frequency Scan

A data set for a frequency scan can consist of up to five partial scans, which are defined by the start frequency, stop frequency and step size. The latter can either be linear (*LIN*) or logarithmical (*LOG*). With logarithmic setting it is entered as a percentage of the respective receiver frequency. The remaining receiver parameter such as bandwidth, detector, operating range, attenuation, mode and measuring time are set in the receiver during definition of the partial scan in the same way as in manual mode, i.e. those receiver parameters that are selected at the time the input is terminated or when leaving the range are used in the partial scan. (Confirmation of the question *Rec settings ok?* using a key in the ENTER area).

Minimum level (*Min Lev*) and maximum level (*Max Lev*) must finally be defined for the complete scan data set. These two levels determine the display range of the plotter or printer output. They are always entered in dB. The unit follows from the unit that is valid for the measurement and depends on the transducer, antenna code or on special functions set.

The scan data set is stored in the RAM with battery backup. Thus it is available again following switch-off of the receiver. If no scan data set was defined or when having called default setting using RCL0, the default data set is automatically set. It consists of to or three range with the following settings:

Table 3-9

	Scan No 1 (with option ESPC-B2 only)	Scan No 2	Scan No 3
Start frequency	9 kHz	150 kHz	30 MHz
Stop frequency	150 kHz	30 MHz	1000 MHz
Step size	100 Hz	5 kHz	50 kHz
IF-bandwidth	200 Hz	10 kHz	120 kHz
Attenuation	AUTO, Low Noise	AUTO, Low Noise	AUTO, Low Noise
Operating range	60 dB	60 dB	60 dB
Detector	Pk	Pk	Pk
Measuring time	100 ms	20 ms	10 ms

Operation:

The menu which offers initial input (*New Set*) and editing (*Edit Set*) of a scan data set is called by pressing the SCAN key in the ANALYSIS keypad. Depending on the selection the different menus for editing or new entry of a data set are offered one after the other until the data set is complete.

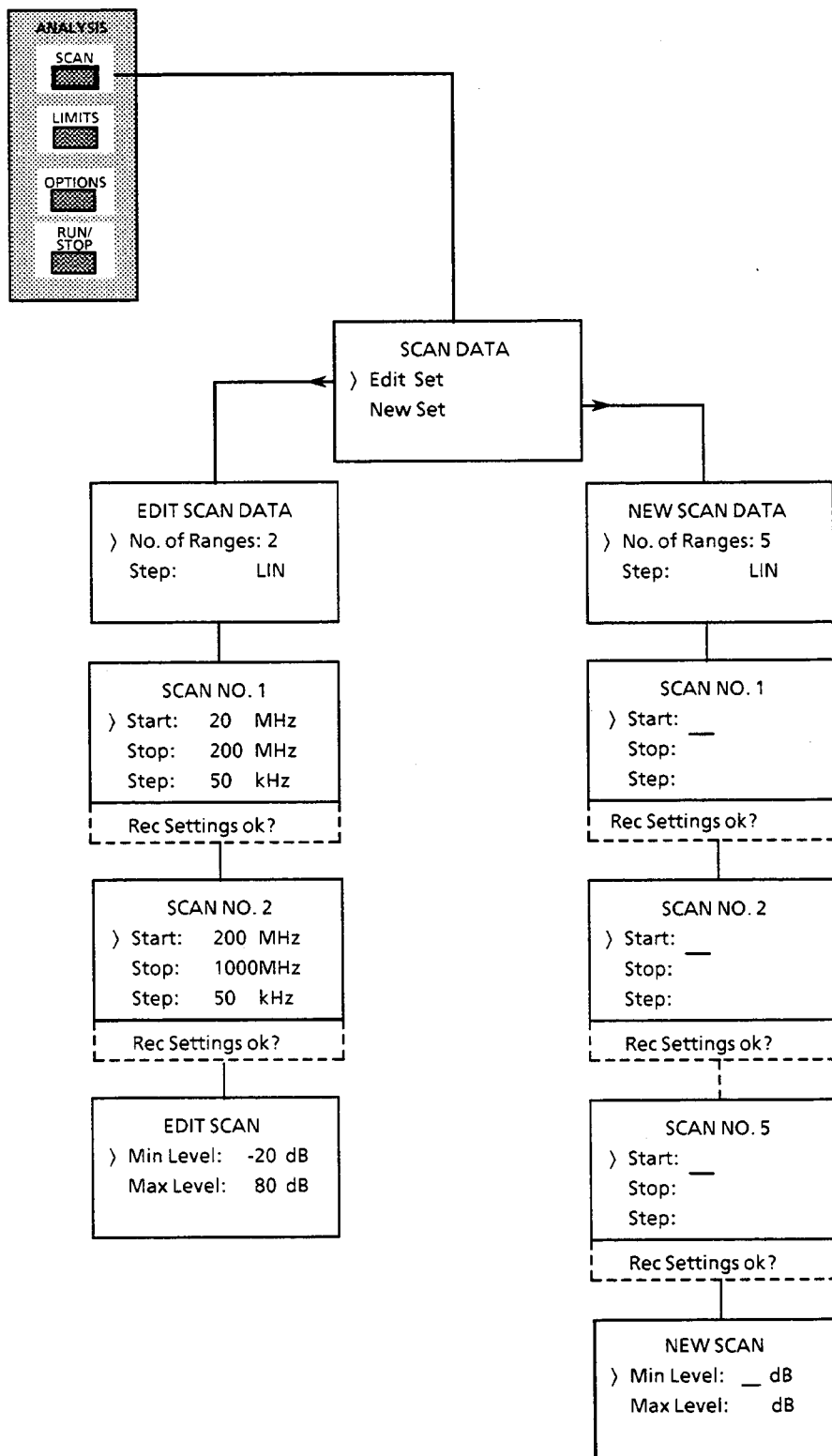

Fig. 3-17 Flowchart of the menus EDIT SET and NEW SET

New Entry of a Scan Data Set: When entering a new scan data set, the number of ranges (*No of Ranges*) which the scan data set is to contain and the type of frequency scan (linear or logarithmic) is first requested. The default values are 1 range and linear frequency scan.

No. of Ranges The number of ranges may be 1 to 5. Frequency scan is set to logarithmic (LOG) by pressing a key in the ENTER area when the cursor is placed on *Step*. Following the selection of the logarithmic step size the sweep step size in each partial scan must be entered in per cent. The range of values for step size is 0.1 % to 100%. (100 %, 50 %, 25 %, 12.5 % ... 0.1 %). If the user enters a step size other than the ones stated above, the next lower step size is automatically set.

Start
Stop
Step When pressing the → key the next menu is entered, in which start frequency, stop frequency and step size of the first partial scan is requested. They are respectively entered together with their unit or in per cent. Unless all parameters requested are entered, the next menu cannot be entered. Following the input of all values the question whether all receiver parameters for the partial scan have been correctly set (*Rec Settings ok ?*) appears in the last line of the menu. The user can thus make sure again that all front panel settings are correct before he presses a key in the ENTER area to affirm the question and thus switches to the next menu.

If ENTER is used, all current receiver settings made for the partial scan - with the exception of the frequency - are adopted for the next partial scan and it is also switched to the next menu. The start frequency of this partial scan (= stop frequency of preceding partial scan) is already set, as there may be no gaps between the individual partial scans. Scan input is terminated when the settings of the last partial scan that is defined in *No. of Ranges* have been entered.

If the stop frequency of a preceding partial scan is already 1000 or 2000 MHz, 1000 or 2000 MHz for the start and stop frequency and 0 kHz or 0 % for the step size is then automatically input in the following ranges. The receiver considers the ranges to be non-existing. Entries can be affirmed by way of ENTER. It can be switched directly from menu to menu using the → key. It is also possible to define several partial scans in this way. The user can intentionally create scan data sets of this kind to have dummy-partial scans, which can be used, if required. It is thus not necessary to enter anew a complete scan data set.

Max Level/ Min Level The minimum and maximum level for scaling the diagram that is output via printer or plotter must be entered in the last menu. Multiples of 10 are only permissible. Deviating inputs are automatically rounded off (minimum level) or rounded up (maximum level). The minimum display level that can be entered is -200 dB, the maximum one is +200 dB. The unit is the one that is currently valid for the receiver. The minimum display range (*Max Lev. - Min.Lev.*) is 10 dB.

Editing an Already Existing Scan Data Set: As with new entry the number of ranges and type of frequency scan (linear or logarithmic) of the already existing data set is displayed in the first menu.

When increasing the number of ranges, further ranges can be added directly with higher values; when decreasing the number, the ranges with the highest values are deleted.

Step After having exited the menu (→ key) the first defined partial scan appears. At the same time all receiver settings defined for this partial scan are set in the ESPC and displayed.

Start
Stop If the partial scan that is to be changed is already known, the menu can be quickly scrolled through using the → key. If, however, the type of frequency scan is changed, the step size must be entered in each partial scan as it is deleted. Unless this is done, the partial scan menu cannot be exited. Start frequency, stop frequency and step size can be edited by selecting the corresponding menu point by way of the cursor and immediately entering new values. When pressing a ENTER key the old value is retained and the cursor moves to the next line.

Changing the stop frequency changes the start frequency of the next partial scan. From the second partial scan onward the start frequency cannot be changed anymore as there may not be any gaps between the individual scans. It can only be changed by entering a new stop frequency for the preceding partial scan.

Rec Settings ok ? The question whether all receiver parameters for the partial scan have been correctly set (*Rec Settings ok ?*) appears in the last line of each menu. The user can thus make sure again that all settings are correct before pressing ENTER to affirm the question and to switch to the next menu.

Min Level
Max Level Level display range (*Min Level* or *Max Level*) for output of diagrams can be modified in the last menu for editing the scan data set.

3.2.4.3.2 Input of Limit Lines

The various regulations covering interference measurements include limit values that may not be exceeded. With logarithmic frequency display these values are usually composed of straight lines. In some standards several limit values are specified, e.g. a limit value for quasi-peak and one for average weighting.

The ESPC allows to define and store remanently up to 22 different limit lines. In order to distinguish the different lines they may be supplied by a number (1 to 22) and a name (max. 8 characters).

As in practice the necessary number of points for the limit values is specified differently in the various standards, the maximum possible number of values depending on the number of the limit line is grouped according to the following table:

Table 3-10

Number of Limit Value	Max. Points
1 to 10	10
11 to 20	20
21, 22	50

Two of these 22 limit lines can be activated for measurement. If a name is specified for the limit value (max. 8 characters), it is also output in the test diagram.

The defined limit lines are stored in the RAM with battery back-up and can be activated or deactivated, if required.

Activated limit lines are used to determine whether limits were exceeded during final measurements in the RF analysis and in the special function 16 (*Check Limit* see chapter 3.2.3.13). With double test modes, the test receiver automatically assigns the detector to the limit line which is to be compared. When this occurs, the detector which measures the higher level refers to the limit line with the larger value.

Operation:

New entry or editing of limit lines is called by pressing the LIMITS key in the ANALYSIS keypad. In the appertaining main menu the user can select between activating or deactivating (*Activate/Deactivate*), editing (*Edit*), i.e. new entry or changing of limit lines. Furthermore it specifies the current status of the receiver relating to the limit lines.

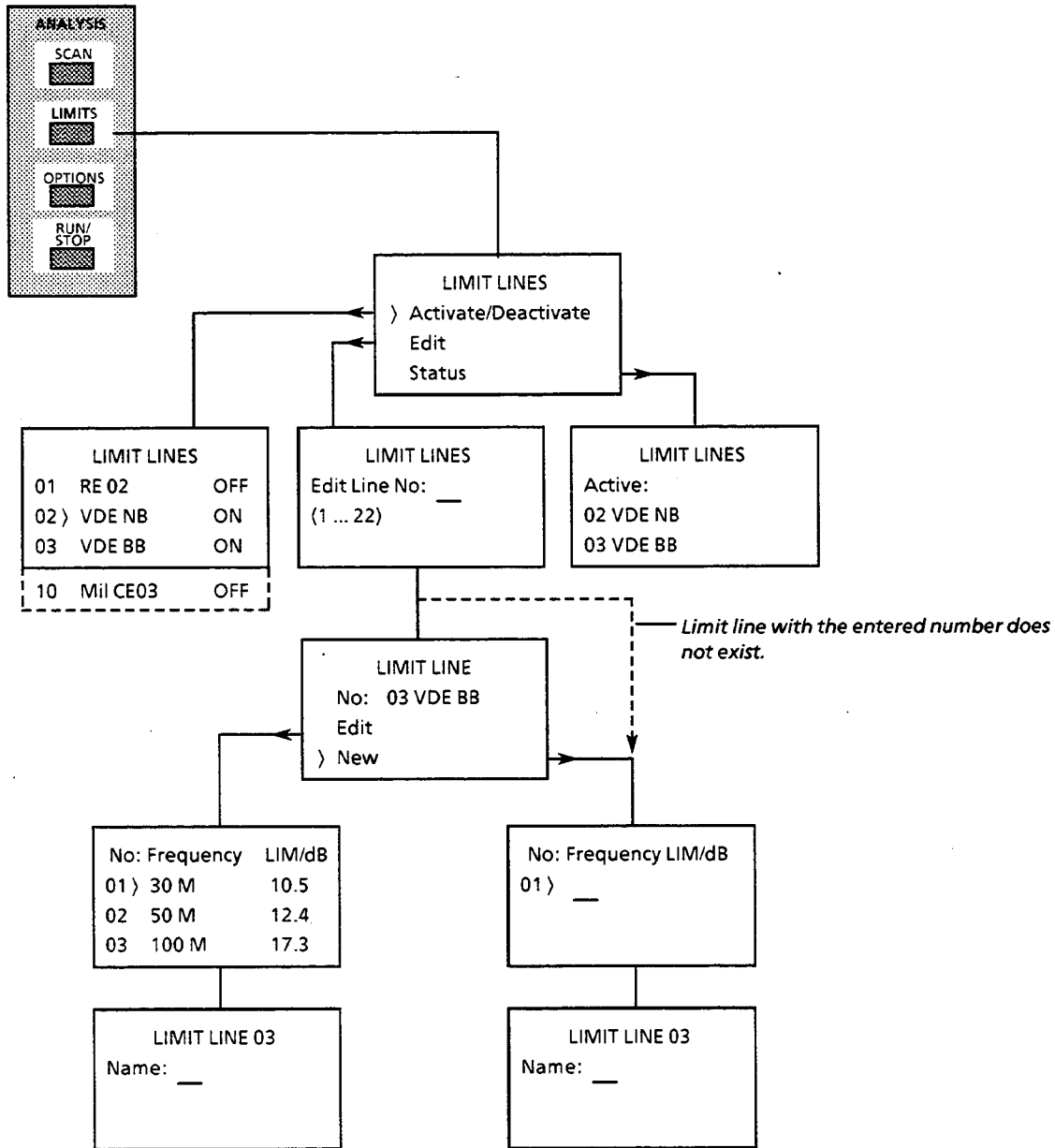

Fig. 3-18 Flowchart for new entry or editing of limit lines

Activating / Deactivating of Limit Lines
(*Activate/Deactivate*):

In this menu a stored limit line is activated or an active limit line is deactivated. If there is an active limit line, the name of the menu point is *Activate / Deactivate*; if there is no active one, the menu is only referred to as *Activate*. After having selected the menu point a submenu, in which all the defined limit lines together with their number, name and current status are listed, is called. If there is no defined limit line, the message "None defined" appears in the display. The cursor is placed on the active limit line with the lowest number, or, if there is no active one, on the line with the lowest number of all limit lines.

The cursor is placed on the factor to be edited using the ↓ and ↑ keys or by entering the appertaining two-digit number (e.g. 01 must be entered for factor 1). If the factor with the number entered is not defined, the message "*<xx> undef*" (<xx> = number entered) appears in the last line of the display. The status of the limit line can be changed (ON → OFF, OFF → ON) by pressing the ENTER key. If there are two active limit lines, the cursor jumps automatically to the second active line after having deactivated a line.

Only two limit lines, respectively can be active at one time. When trying to activate a third one, the message "*Max 2 Limits!*" is output. Before activating the desired limit line an already active one must be deactivated. The menu is exited using the ← key or EXIT.

**Editing of
Limit Lines:**

When calling the EDIT menu the limit line to be edited is requested in the first sub-menu. It must be entered by its appertaining number. If there is no limit line with the selected number, the blank table for entering the points appears. If a limit line with the selected number does already exist, its name is output in the following menu and a selection between editing (*Edit*) and new entry (*New*) is offered. In the case of new input the blank table appears. If "*New*" was selected by mistake, the former limit line may be restored by pressing the ← key prior to complete input of the first point.

**New Entry of
Limit Lines:**

New entry of limit values must be performed in the sequence of increasing frequencies with frequency and level of the limit value. The cursor is placed on the frequency of the first point at the beginning. Following frequency input (terminated by MHz) the cursor jumps automatically to the appertaining level value. Values of -200 to +200 are permissible for the level. When exceeding these limits the messages "*Max Level 200 dB*" or "*Min Level - 200 dB*" result. The input unit is always dB, i.e. the unit of the limit value is adapted to the unit valid during measurement, which usually depends on the transducer used. After having completed input of the point the cursor jumps automatically to the next one.

If the increasing order is not adhered to, the message "*Freq Sequence!*" is output and the frequency input is ignored, i.e. entry is not accepted.

If the maximum number of points has been entered, the input menu is automatically exited. It can also be exited beforehand by pressing the ENTER key while the cursor is in a blank frequency field or by using the → key. The limit line can finally be provided with a name (*Name*) in the following submenu. Input can be performed either via the external keyboard or via the auxiliary lines for text input (cf. section 3.2.4.1.2), if the keyboard is not connected. Maximal 8 characters are permitted for the name. If no name is desired, the field *Name* may be left blank.

**Editing of
Already Existing
Limit Lines:**

When editing limit values a point can be deleted, a new one can be inserted or only any frequency or level value can be changed. Inserting or deleting a point is possible, when the cursor points to the number of the point. It is deleted using the DELETE key and the subsequent values move up. A free line is created at the position of the cursor using INSERT and all following points are raised by one number. When entering the new frequency in the new line it must be ensured that the frequency order is kept as otherwise input is not accepted. If the limit value has already the maximum possible number of points, it is not possible to insert a new one. In this case the message "*Max <xx> values*" (<xx>: the maximum number of points which is dependent on the number of the limit line, cf. table 3-10) appears in the bottom line.

A frequency or a limit value can be changed when placing the cursor on the desired position. When entering a figure the old value is deleted and the new one is displayed. Stick to the increasing frequency sequence in this case, too.

The EDIT menu is exited either by way of the ← or → key or, when the cursor is on the last point by pressing the ENTER key. The menu for the name appears in the DATA INPUT display (cf. New Entry of Limit Lines).

Display of Active Limit Lines: In the menu Limit Status the limit lines currently activated are indicated in the second and third line. They are represented together with their number and name, if the latter is defined. If no limit line is activated, *none* is indicated in the menu.

3.2.4.3.3 Extended Functions of RF-Analysis (OPTIONS)

The *Options* of the ESPC offer new functions that serve for adapting the RF-analysis to specific measurement problems or to optimize measurement runs for various applications. A significant feature is data reduction. It is achieved by dividing the frequency range into subranges. During a pre-test the maximum interference is searched for in a subrange. A measurement is immediately carried out at this maximum in the desired indicating mode - usually quasipeak or average value. In any case it is thus ensured that the highest interference levels are measured with weighting. The relatively time-consuming measurement procedures must however only be carried out with a limited number of frequencies, so that total test time is considerably less. In the case of RFI voltage measurements with artificial networks it is also possible to switch over the phase for weighted measurement, if required. This ensures that the highest interference is detected. The user himself largely determines the measurement run by combining the various options in different ways. Thus the number of subranges (max. 400), parameters of the pre-measurement, type and phases of artificial network, type of weighted measurement and its measuring time and the threshold value for which a weighted measurement is to be performed can be freely determined by the user. How to carry out the measurement is described in section 3.4.

Operation:

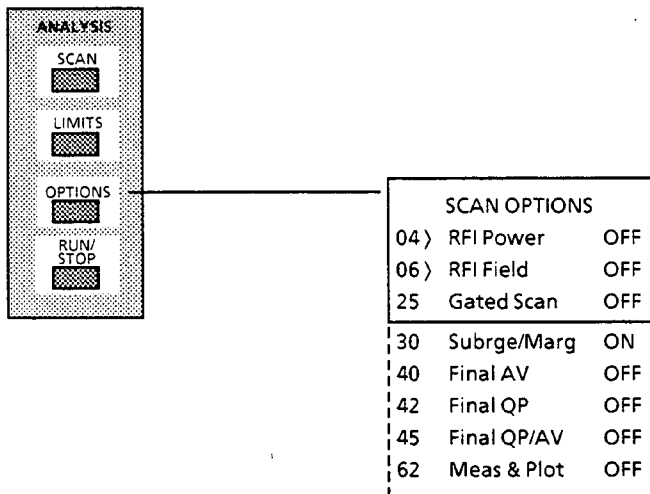

Fig. 3-19 Calling the SCAN OPTIONS menu

The cursor is placed on the desired option using the ↑ and ↓ keys or it is directly entered using its number. The status of the scan options is switched over by way of ENTER (OFF → ON, ON → OFF). Some of the scan options require additional entries. In this case, a submenu in which the necessary values can be input is called during switch-on. The main menu is exited when calling any other menu or by way of the EXIT key.

OPT 01, RFI Voltage:

The option together with an Artificial Network ESH2-Z5 or ESH3-Z5 and a plotter and/or printer allows to carry out a complete RFI voltage measurement with documentation of the measurement results. (How to use the function, cf. section 3.4).

Switching on the phase in the submenu *PRESCAN/MANUAL* also causes a connected Artificial Network to be switched on at the same time. This makes it possible to manually select the phases from the receiver. If the Artificial Network is switched off with *OFF*, the remote control is disconnected.

OPT 04, RFI Power:

With this option, the ESPC together with an absorbing clamp and a plotter and/or printer allows for semi-automatically carrying out a complete RFI power measurement with documentation of the measurement results. (How to use the function, cf. section 3.4)

OPT 06, RFI Fieldstrength:

This option supports preliminary RFI fieldstrength measurements in an RF cabin and subsequent measurements in the open field. (cf. section 3.4.3 for application of this option)

OPT 25, Gated Scan:

Default setting of the option is OFF.

With the option switched on, frequency scan starts with a positive edge at the input "External Trigger" (pin 1) of the USER INTERFACE. It continues as long as HIGH level is applied to the input. When the level changes to LOW, frequency scan stops. Following the next positive edge it starts again at the position where it was interrupted.

The function contributes to a considerable reduction in measuring time required for devices under test featuring intermittent interference or systems which are only irregularly activated. The trigger level must be generated by the device under test, itself.

OPT 30, SUBRGE/MARGIN:

Default setting is ON. This option is used in connection with option 01. The user can specify the number of subranges (*SUBRGE(S)*) at the maximum levels of which a final test is to be carried out and the level margin (*ACC MARGIN*) compared to the limit line at the frequency from which onward measurement is carried out. Application is described in section 3.4 in connection with options 04 and 06.

Operation:

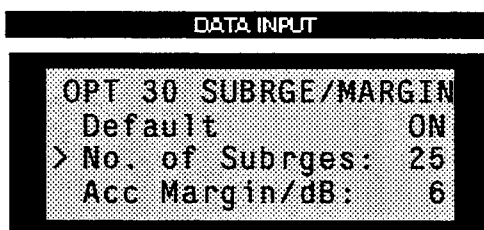

When calling option 30, a submenu appears, in which the required number of subranges and the difference relating to the limit line from which onward a weighted measurement is carried out can be entered. The values of the default setting are 25 subranges and a margin of 6 dB with respect to the limit line. New values can be input by placing the cursor on the desired line and entering a new value.

The permissible values for the number of subranges are 8, 16, 25, 50, 100, 200, 400 (maximum value). When entering a value other than the ones stated above, it is rounded up or down to the next permissible one. For the margin to the limit line all the values between -200 dB and +200 dB are permissible. A positive value leads to a margin that is below the limit line..

If no limit line is defined in a subrange, the final measurement is performed on all subrange maxima independently of their levels.

The menu can be exited using EXIT

Option 40: Final AV

Option 42: Final QP

Option 45: Final QP/AV:

Default setting is OFF.

With the options 40, 42 and 45 ON, quasipeak measurement, average measurement or both is automatically effected at the maximum levels of the subranges following a measurement with scan. One function only can be switched on at one time. When activating one option, the other two are automatically switched off. The options directly influence the scan parameters of the final measurement. Weighting depends on the activated option and is performed using the following detectors:

Option	Detector for over-view measurement
40 Final AV	AV
42 Final QP	Pk
43 Final QP/AV	Pk + AV

Application is described in section 3.4.

Operation:

- ▶ Place the cursor on one of the options 40, 42 or 45:
- ▶ Press ENTER.

With option 45 for example, the following submenu is called:

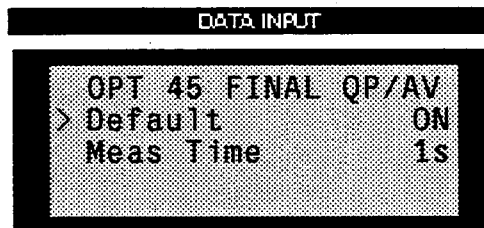

In this submenu measuring time required for measuring again at the maximum levels of the subranges is specified.

- ▶ Place the cursor on *Meas Time* for this purpose and then enter the desired measuring time.
- ▶ Set the basic setting (cf. menu) by way of *Default*.

The menu is exited using EXIT or ← and option 45 is displayed with ON in the option menu. When pressing ENTER while the status is ON, the option is deactivated (status OFF).

Option 62, Meas & Plot:

Default setting of the option is OFF.

To allow to follow the measurement run, the measurement curve can be output on plotter during frequency scan. Labelling and graticule are output prior to the measurement curve.

"Error Message"

If no plotter is connected or it is set to another address than specified in the SETUP menu, the message *Connect Plotter!* is read out in the display DATA INPUT. After having connected a plotter the scan is started by pressing a key in the ENTER area. When pressing only a ENTER key measurement is started without a plot.

In case the IEC bus is switched off (Spec Func 11 or operation with internal battery), the message "IEC Bus OFF LSF 11" is output. Switch on the IEC bus using Spec Func 11 and restart the plotting process in this case.

If a plotting process activated prior to starting a scan has not yet been terminated, the note "WARN: Plotter active" is output and the scan is not started in this case. Before restarting the scan using "RUN" wait until the data are completely output to the plotter or switch off option 62.

When starting the scan everything defined under the point *Report Setting* in the menu *Plot Contents* is plotted. If *Curve* is not activated in this menu, a warning results: "Warn: Curve OFF"

Option 63, Special Scan: When *Special Scan* is selected, one measurement at each of the frequencies defined in a frequency data set is carried out with the desired receiver settings. Thus it is possible to obtain a measurement result in minimum time, if the frequencies of emitted interferences are known.

Example:

Measurement of emitted interference at the clock frequency of a processor.

Frequencies for the special scan are entered using the SCAN key. Input menus are different from those of a conventional scan.

Operation:

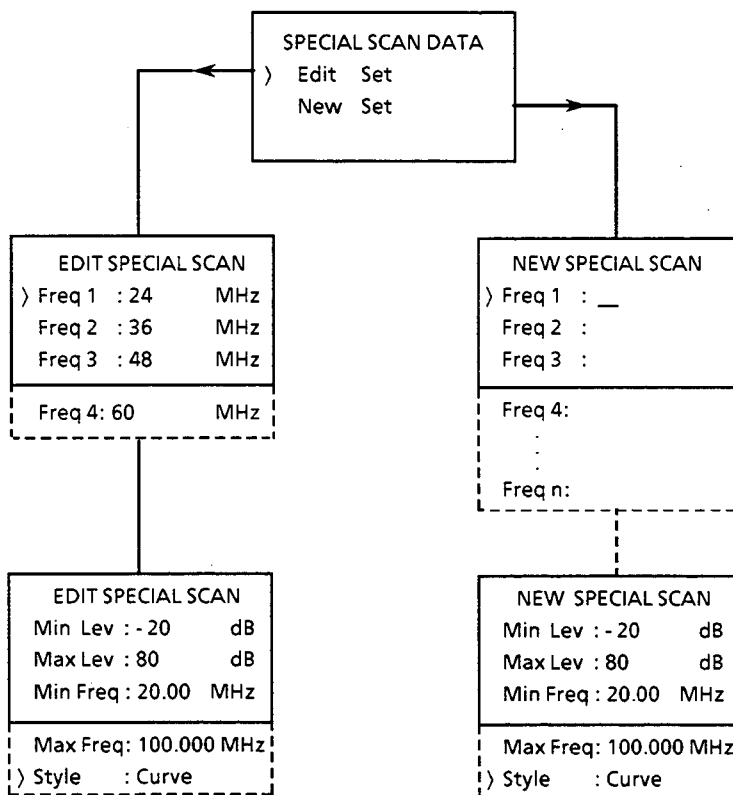

Fig. 3-20 Flowchart for input of a special scan

In the first menu it is possible to select between editing of an already existing data set and new entry. The following menus are essentially the same.

400 frequencies at the most can be entered. The individual frequencies must be entered in increasing sequence. Frequency inputs that are not in line with this order are not accepted. The error message *Freq Sequence!* results. When editing the data set, it is possible to insert additional frequencies using INSERT or delete them by way of DELETE.

The edit menu is exited by way of the ← or → keys or, if the cursor is on a blank input line or on the maximum possible interpolation value by the ENTER key.

Following the input of all frequencies, level and frequency limits must be entered for plotter or printer output.

The *Style* function allows you to select the way a measurement curve is represented on a printer or a plotter. Pressing the ENTER key switches between closed curve sections (*Curve*) and small vertical lines (*Line*).

3.2.4.3.4 Frequency Scan

A scan is started by pressing the RUN/STOP key. It runs in accordance with the set special functions (cf. section 3.2.3.12), transducer factor or transducer set (cf. section 3.2.4.2.1) and options. If several ranges are defined in an active transducer set, the receiver stops at the range intersections and requests changing of the transducer. The data measured are stored in the internal RAM (cf. Options and section 3.4) Max. 30.000 measured data can be internally stored. If more measured values are produced, they are not available any more for further processing (e. g. subsequent output via the IEC bus). Nevertheless, a complete diagram is always output, since only the 400 upper values of the scan are required. The stored data get lost, when switching off the receiver.

Operation:

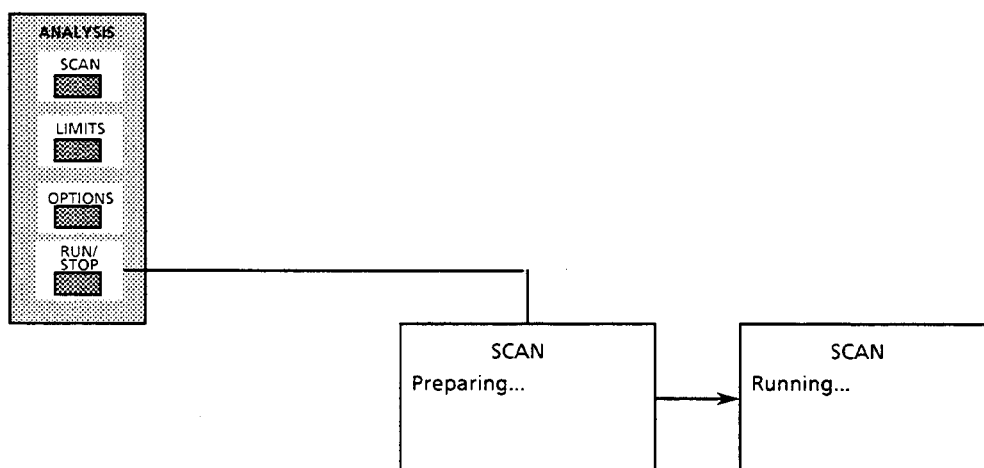
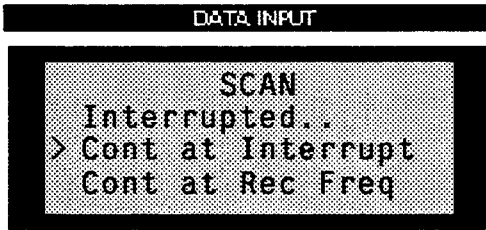

Fig. 3-21 Calling the SCAN menu

- ▶ Press RUN/STOP key.
Frequency scan is initiated. At the beginning the ESPC generates a data set which contains the correction values consisting of frequency response correction values from the total calibration and transducer factors for all frequencies. While establishing the data set *Preparing...* is indicated in the DATA INPUT display. Subsequently the frequency scan starts. The DATA INPUT display shows *Running...*

- ▶ Press RUN/STOP key.

Frequency scan stops. The receiver can now be operated manually to allow e.g. closer examination of the receive signal at a frequency by monitoring or switching over of the detector or measuring time. The following menu appears in the DATA INPUT display:



- ▶ Select *Cont at Interrupt*

Frequency scan continues at the position where it was interrupted with the settings defined in the scan data set.

- ▶ If the receiver frequency is lower than that at which the scan was stopped, the frequency scan continues at the position where the receiver is at the moment with the settings defined in the scan data set when selecting *Cont at Rec Freq*. If the frequency is higher, the scan is started at the frequency at which it was interrupted. Thus part of the frequency scan can be repeated, if there has been any irregularity. The measured values already stored are deleted and replaced by the new ones. If the results are simultaneously output via plotter, the old measured values are overwritten.

- ▶ If the scan was interrupted and the RUN/STOP key is pressed, frequency scan is stopped. The data already measured get lost. The measurement can only be started from the beginning by activating again the RUN/STOP key.

At the intersection of transducer set ranges it is requested to change transducer by the following menu:

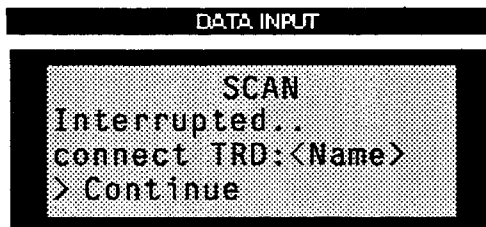

- ▶ After having changed the transducer, frequency scan continues when a key in the ENTER area is pressed.

Note: *If an active transducer factor or set is not defined over the whole range of the scan, invalid measured values result in the range where the transducer is not defined. To inform the user about it the following error message is output on the DATA INPUT display:*

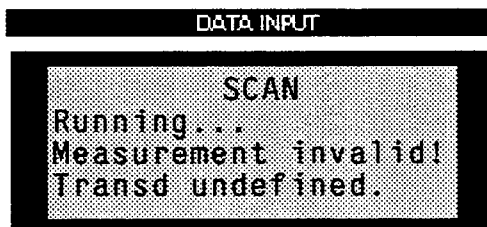

Valid measurements are carried out only at the frequencies where a valid transducer is defined.

After termination of the frequency scan a beeping tone is output, if the beeper is activated and the hint *Complete* appears in the DATA INPUT display.

3.2.4.4 Generating a Test Report (Report Keypad)

The result of a measurement run can be output both on a printer with Centronics interface and via IEC bus on a plotter with HP-GL interface. Any 24-pin printer, which is EPSON-compatible, HP DeskJet or HP Laser-Jet II, may be used. The contents of the plotter or printer output can be determined by the user himself.

The following outputs are feasible:

- Measured value diagram with limit lines,
- Measurement settings of the receiver,
- Measuring curves,
- User-definable heading,
- Measuring value table and
- Date and time.

Thus it is possible to e.g. output the diagram on plotter and simultaneously the measured value table on printer. Plotting can also be carried out during the frequency scan (cf. section 3.2.4.3.3).

In addition to final results of an RF analysis scan, the results of a prescan can be copied in tabular form to a printer. The parameter *Scan Res List* in the *Printer Setting* menu has to be switched ON. If a limit line is active and a margin was defined, only those values which exceed the limit and margin during a scan are printed out.

The menu for setting the printer is displayed in the following manner:

DATA INPUT	
PRINTER SETTING	
> Default	ON
Final Results	ON
Scan Res List	OFF

Title	ON
Scan Table	ON
Diagram	OFF
Page Count	ON
Epson 24	ON
DeskJet	OFF
LaserJet	OFF

Displayed after the REPORT SETTING key has been pressed. Set cursor to Printer and press one of the ENTER keys.

Can be scrolled using ↑ and ↓ keys

3.2.4.4.1 Selecting the Pre-setting of the Printer and Plotter

The user himself can largely determine the test report by selecting the presetting of the printer or plotter. He can select the level display range by entering the minimum level (*Min Lev*) and maximum level (*Max Lev*) when defining the scan parameters (cf. section 3.2.4.3.1). In addition the user can select between linear (*Lin*) and logarithmic (*Log*) scaling of the frequency axis. He can also specify what is to be part of the test report. When using the plotter for output, the colors for the individual components of the display can be chosen differently to provide for a more easy-to-understand plot.

The presettings are stored in the memory with battery back-up so that usually the settings must be effected only once. They are even maintained after having called the default setting of the ESPC with the help of RCL 0 (cf. section 3.2.4.5).

Operation:

The menus for determining the design of the measured value output and presettings of the printer or plotter are called using the SETTING key in the keypad REPORT. In the first menu (REPORT SETTING) the user can select between presetting of the plotter or printer. In addition the scaling of the frequency axis can be specified in this menu.

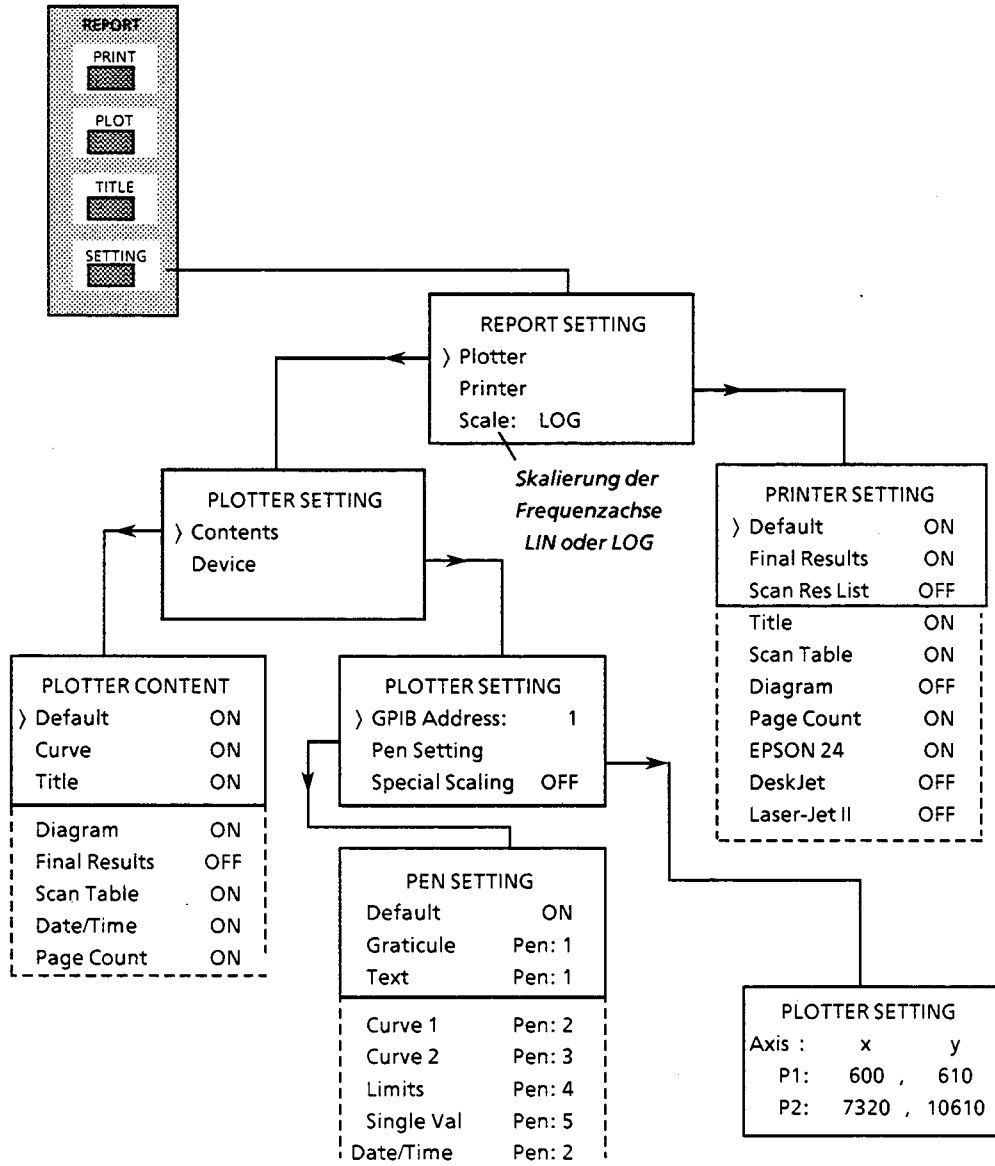

Fig. 3-22 Presettings for plotter or printer output

Scaling the Diagram:

Linear or logarithmic scaling can be chosen for the frequency axis. Default setting is logarithmic scaling. If the ratio between maximum and minimum frequency is, however, lower than 1.5, the measured value diagram is automatically output with linear frequency scaling.

The scaling can be switched over using the ENTER key, when the cursor is placed on scale (LOG ↔ LIN).

Presetting of the Plotter:

In the menu *PLOTTER SETTING* a distinction is made between contents (*Contents*) of the report and device setting (*Device*) of the plotter.

Contents

In the menu *PLOTTER CONTENTS* the various components of a plot can be activated or deactivated. These are

- the graticule with frequency and level labelling and, if defined, the limit lines (*Diagram*),
- the heading defined by the user (*Title*, cf. section 3.2.4.1.1),
- the measured value curve(s) (*Curve*),
- the table with measured values (*Final Results*),
- the table with the list of scan and partial scan settings used with the appertaining receiver parameters (*Scan Table*) and
- date and time
- page numbering (*Page Count*)

Default setting (cf. fig. 3-22) is output with graticule including labelling, heading, date/time and test curves. The measured value table is not part of the default setting as it can be output more conveniently and quicker on a printer.

Device

DEVICE SETTING is used to set the GPIB-address of the plotter, to assign the pens of the plotter to the graticule, labelling, test curves, limit lines and the measured values and to set the scaling of the test report. Values between 0 and 30 can be entered for the IEC-bus address. Other inputs are not accepted, i.e. the original value is maintained.

Pen Setting

A submenu in which the individual plotter pens can be assigned to the various components of the test report is called using the menu point *Pen Setting*. With default setting (Default ON) the pens are selected as shown in fig. 3-22. When selecting a different pen assignment, default changes to OFF. Figures from 0 to 8 are permissible for the pen number. Other inputs are ignored, i.e. the former value is kept. Entering the figure 0 means that no pen is selected.

Special Scaling

If another type of scaling of the test report than that specified by the plotter used is desired, the bottom left (P1) and the upper right (P2) corner of the report can be set separately with the help of the menu point "*Special Scaling*". When activating this menu point a submenu is called in which the values selected for P1 and P2 are entered. Values ranging from - 32768 to (+) 32767 are permissible for the coordinates. Illegal values are not accepted. The values for the coordinates depend on the plotter used and must be learnt from the manual of the plotter. The ESPC is preset for the use of the R&S-plotter DOP (cf. fig. 3-22).

The following table specifies useful coordinate settings for several plotter types.

Plotter type	P1		P2	
	X	Y	X	Y
DOP (R&S)	600	610	7320	10610
R9833(Advantest)	650	610	7200	10610
Color pro (HP)		Special	Special	Scaling OFF
HP 7475		Special	Special	Scaling OFF

After having ended the input the status of *Special Scaling* changes to "ON".

Presetting of the Printer:

The menu for setting the printer (PRINTER SETTING) offers the selection between the various elements of a report similarly as with plotter output (see above). Default setting means output of the title with measured value table and output of the scan settings (cf. fig. 3-22) on EPSON-compatible, 24-pin printer.

3.2.4.4.2 Input of the Labellings for Printer or Plotter Output

To provide complete documentation of the measurement results the printer or plotter report can be labelled individually. The following entries can be made:

- *Heading,*
- *Measurement Type,*
- *Equipment u. Test,*
- *Manufacturer,*
- *Operating Condition,*
- *Operator,*
- *Test Specification and*
- *Comment 1 and Comment 2 (two lines for comments).*

Operation:

The menu *TITLE*, in which the elements possible to label are stated, is called using the TITLE key in the keypad REPORT. The desired point is selected using the cursors. The following input menu varies depending on the instrument equipment available. If an external keyboard is connected, the desired text can be input using the same. Otherwise input can be made via the auxiliary line editor in the last two lines of the menu (operation cf. section 3.2.4.1.1).

In both cases 40 characters are maximally possible for each labelling element. Two lines with 60 characters each are permissible for the comment. Additional characters are not accepted.

The following menu tree shows the input of the labelling e.g. in the case of the title:

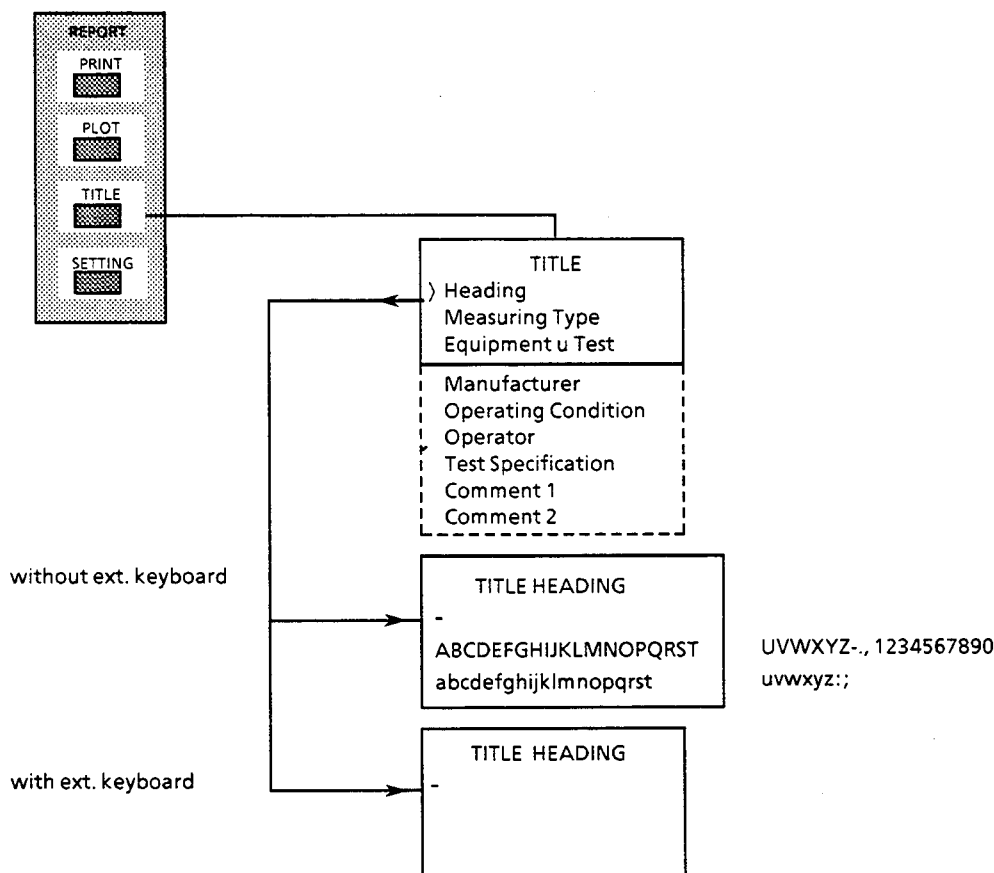

Fig. 3-23 Menu tree for input of the labelling

3.2.4.4.3 Output of the Measurement Results on Printer

When pressing the PRINT key the printer connected immediately starts to print the measurement results in the form they are configured in the *SETTING* and *TITLE* menus. If no printer is connected or it is not ready for operation, the message "Connect Printer!" is read out on the DATA INPUT display. After having connected a printer the printing process must be started again.

Printing is a background process, i.e. the receiver can be operated during printing. However, fast measurements take somewhat more time.

Printing can be stopped at any time using *Abort Printing*. In this case printing must be re-started for a further printout.

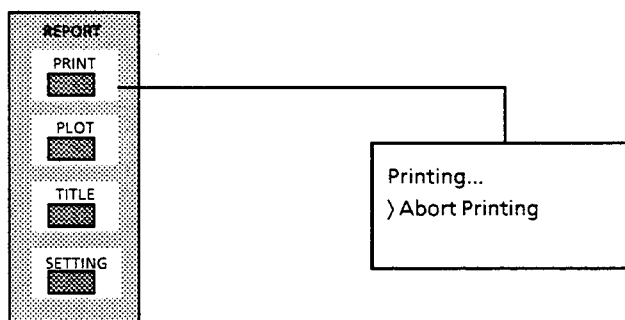

Fig. 3-24 Start of printer output

3.2.4.4.4 Output of the Measurement Results on Plotter

When pressing the PLOT key the plotter connected immediately starts to plot the measurement results in the form they are configured in the SETTING and TITLE menus. If no plotter is connected or the plotter connected has a GPIB-address different from that entered in SETTING, the message "Connect Plotter!" appears on the DATA INPUT display. After having connected a plotter or changed the address, plotting must be initiated again.

No other controller may be connected to the bus upon start of the plotter output, since otherwise the ESPC cannot adopt control of the IEC-bus (message on DATA INPUT display: "Bus Control required"). In such a case the controller must be disconnected from the IEC bus or pass control to the ESPC.

With the IEC bus out of operation (Spec Func 11, cf. section 3.2.3.12), start of plotter output is acknowledged by the message "IEC Bus OFF LSF 11". After the IEC bus has been switched on, the plotting procedure must be started again.

Pressing the PLOT key again when the plotting procedure has not yet been terminated causes the message: "WARN: Plotter active" to be read out in the DATA INPUT display. This message also appears when the plotter output is started and another plotting procedure which was initiated with option 62 (Meas&Plot) has not yet terminated.

The message *WARN: No Pen selected* indicates that an element of the measurement report, for which no pen was selected (*Pen = 0* in *PEN SETTING*), will be outputted.

Plotting is a background process, i.e. the receiver can be operated during the plotting process. However, fast measurements take somewhat more time.

If output of a measured value diagram and of a table is specified, the former is plotted on the first page and the table on the following pages. The user is requested to change the sheet on plotter by the following message in the DATA INPUT display.

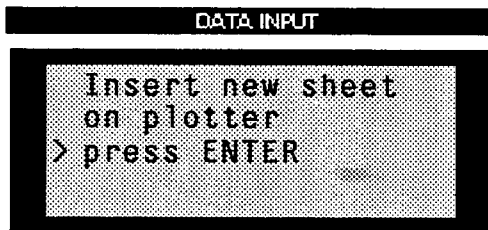

Labelling is repeated on every page.

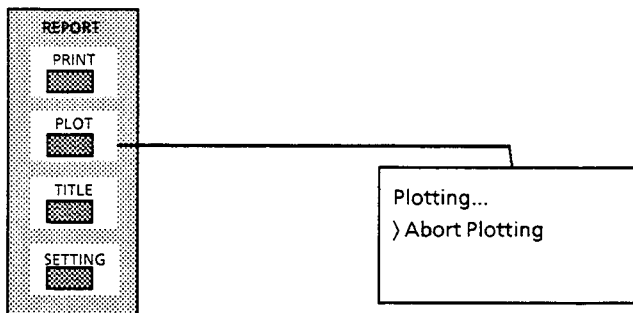

Fig. 3-25 Start of plotter output

Plotting can be stopped at any time using *Abort Plotting*. In this case plotting must be re-started, i.e. the plotting process cannot continue where it was aborted.

ROHDE & SCHWARZ
RFI POWER

24. Apr 91 05:13:33

EUT: Computer
 Manuf: Black & White
 Operator: Wolf
 Test Spec: EN55014-A2
 Comment: Operation without filter

Scan Settings (i Range):

Frequencies				Receiver Setting				
Start	Stop	Step	IF BW	Detector	M-Time	Atten	Preamp	OpRge
30M	300M	50k	120k	PK + AV	1ms	AUTO LN	OFF	60 dB

Final Measurement: * QP + AV Transducer No Start/MHz Stop/MHz Name
 Meas Time: 1 s 1 25.000 1000.000 MDS
 Subranges: 25
 Acc Margin: 10 dB

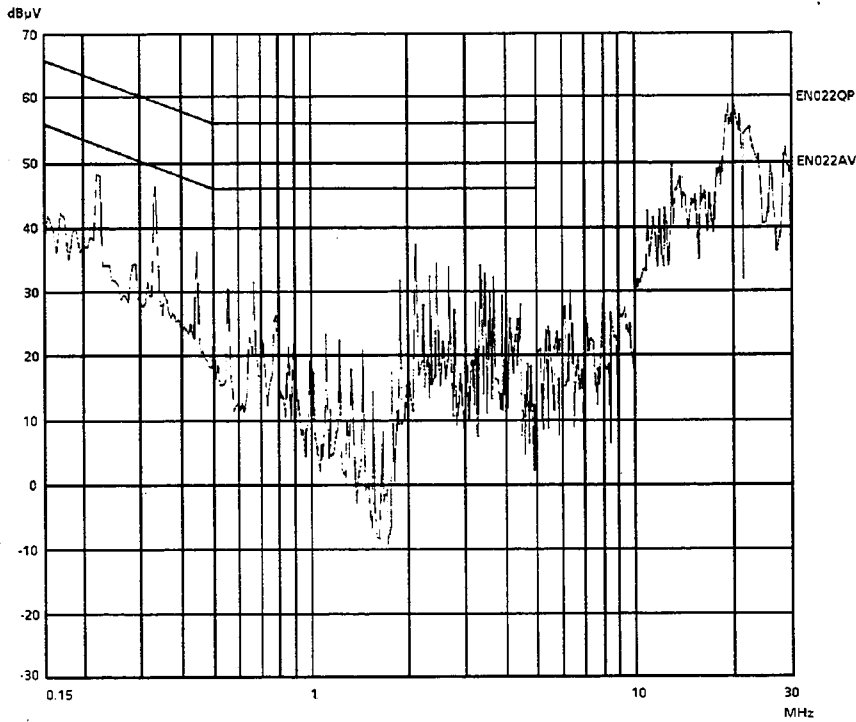

Fig. 3-26 Plotter output

3.2.4.5 Saving and Calling the Receiver Configuration

In the ESPC, 9 complete instrument settings (1 to 9) maximally can be saved. The setting 0 contains the default setting of the receiver and cannot be modified. All the settings are set to their default values using 0. The settings are stored in the internal CMOS-RAM and are thus maintained even after having switched off the instrument. The settings for measurements that are performed repeatedly must only be entered once and can be re-called at any time.

The following parameters are saved:

- All the current receiver settings, such as frequency, attenuation, operating range, detector, etc.
- the special functions activated,
- the transducer settings currently effective,
- the limit lines,
- the scan data set and
- the set scan options.

To facilitate the recovery of settings saved, they can be provided with a name.

Note: *As the limit lines, transducers and data sets for the "Special Scan" in turn contain extensive data sets, they are saved completely only once. The data set stored only contains a hint as to the respective limits, transducers or special scan data. If the latter are changed subsequently, it may occur that the initial transducer or limit cannot be reconstructed any more when re-calling an instrument setting.*

Operation:

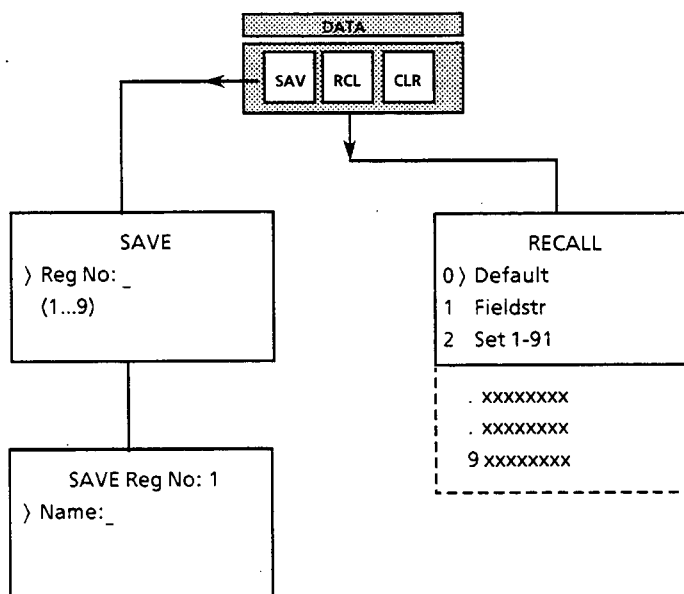

Fig. 3-27

Saving a Device Configuration:

The desired register is requested in the DATA INPUT display when pressing the SAV key in the DATA keypad. The permissible registers (1 to 9) are also shown in the display. If the register is already occupied, its contents are overwritten with the new data set. After having entered the respective number (<number> + ENTER) a further menu appears, in which a name for the register selected can be entered. After having input the name the currently effective configuration is saved.

Recalling a Device Configuration: The key RCL in the DATA keypad serves to call a menu in the DATA INPUT display in which all the occupied registers together with their number and name are represented in the form of a list. The desired register can be called either by entering the corresponding number or selecting it with the help of the cursor. It is not possible to call registers not occupied. In this case the receiver outputs the error message "Register empty".

Default setting of the ESPC (RCL 0):

Frequency:	100 MHz
Step size:	COARSE
Attenuation:	AUTO, LOW NOISE (RF-attenuation \geq 10 dB)
Detector:	AV
IF-bandwidth:	120 kHz
Operating range:	60 dB
Measuring time:	100 ms
Pre-amplifier:	off
Special functions:	Default setting (cf. 3.2.3.13)
Setup:	is not affected
Transducer:	all the transducers defined are deactivated
Limit lines:	all the limit lines defined are deactivated
Options:	none
Scan data set:	Default data set (cf. 3.2.4.3.1)
Printer/Plotter settings:	are not affected

3.2.5 Connecting External Devices

3.2.5.1 Connecting the Transducers (ANTENNA CODE)

The ANTENNA CODE socket is provided for the supply and coding of the conversion factors of transducers. It serves to code the conversion factors of current probes and antennas in 10-dB steps. In addition the receiver is informed on the quantity to be measured (fieldstrength, current and voltage). Active transducers can be supplied with ± 10 V by the socket.

The following R&S-accessories are available with suitable coding:

- Passive Probe 9 kHz to 30 MHz ESH2-Z3,
- Active Probe 9 kHz to 30 MHz ESH2-Z2,
- Rod Antenna 9 kHz to 30 MHz HFH2-Z1,
- Rod Antenna 9 kHz to 30 MHz HFH2-Z6,
- Loop Antenna 9 kHz to 30 MHz HFH2-Z2
- RF-Current Probe 100 kHz to 30 MHz ESH2-Z1
- Current probe 20 Hz ... 100 (200) MHz EZ-17
- VHF current probe 20 ... 300 MHz ESV-Z1
- Broadband dipole 20 ... 80 MHz HUF-Z1
- Preamplifier 20 ... 1000 MHz ESV-Z3

It is, however, recommended to enter the exact conversion factor via the transducer factors to achieve higher measurement accuracy (cf. section 3.2.4.2.1).

The coding can be rendered ineffective using the special function SPEC FUNC 12. This is useful if with an active transducer the supply is to be used, however the coding is not desired. If a transducer is used during the measurement, the coding at the ANTENNA CODE socket is automatically rendered ineffective.

For fieldstrength measurements in shielded rooms, if the ESPC is operated outside the room, the shield of the supply and coding cable must be fed through the screen of the room, such that there is no emitted interference inside the room. The ANTENNA CODE socket is assigned as follows:

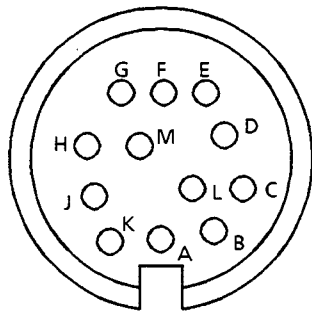

- A ground
- B + 10 V, max. 50 mA
- C $\mu\text{V}/\text{m}$ (electr. fieldstr.)
- D μA
- E 10 dB
- F 20 dB
- G 40 dB
- H 80 dB
- K - 10 V, max. 50 mA
- M - Reversing the sign of the factor

Fig. 3-28 Assignment of the 12-contact Tuchel-type female connector .

A 12-contact connector (Tuchel-type, R&S-order number 0018.5362.00) is used for coding. The inputs for the code must be connected to ground.

Example: An antenna for electric fieldstrength measurements has an antenna factor of 10 dB, i.e. a fieldstrength of 10 dB $\mu\text{V}/\text{m}$ produces a voltage of 0 dB μV at the RF-input.

- ▶ The pins C and E must be connected to ground.

3.2.5.2 AF-Output

An external loudspeaker, headphones or, e.g., an AF-voltmeter can be connected to the AF OUTPUT socket using a PL-55-connector. The internal resistance is 10 Ω , output power is higher than 100 mW. If a connector is connected, the internal loudspeaker is automatically switched off.

3.2.6 Inputs and Outputs at the Rear Panel

3.2.6.1 IF-Output 10.7 MHz (10.7 MHz OUTPUT)

The 10.7-kHz output is suitable for tests with oscilloscope, spectral analysis and examination of the modulation. The bandwidth is equal to the IF-bandwidth selected.

The output voltage (EMC) is 1 mV to 1 V in the 60-dB range
 and 1 mV to 30 mV in the 30-dB range.

3.2.6.2 Input for External Reference (EXT REF INP)

To increase the frequency accuracy of the ESPC, an external frequency standard can be connected to the connection EXT REF INPUT (pos. 32, fig. 3-2). A 10-MHz signal with a nominal level of 1 V at 50 Ω is necessary for this purpose. A level of 3 dB is usually sufficient.

Operation:

- ▶ Press SETUP key.
The setup menu appears on the DATA INPUT display .
- ▶ Set cursor to menu item Ext Ref using the \downarrow key.
- ▶ Switch the external reference ON or OFF by pressing one of two ENTER keys (toggle switch).

3.2.6.3 USER INTERFACE

The USER INTERFACE at the rear panel of the ESPC is a 25-contact CANNON-socket, to which five different signal groups are assigned. It contains the following interfaces:

- Serial Interface (RS232-C) for loading the firmware,
- Internal serial bus for control of accessories,
- 6 parallel TTL-control lines (port 1 to port 6),
- +5-V- and +12-V-voltage for supply of external devices and
- analog outputs for the display voltage.

The pin assignment is shown in the following figure:

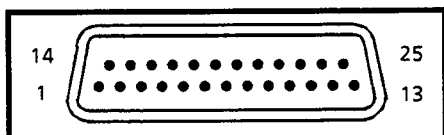

Pin	Signal	I/O	Meaning
1	EXTRIG	I	Ext. trigger, switchable pos./neg. trigger
2	RxD	I	Received Data: transmits ASCII data from computer to receiver
3	TxD	O	Transmitted Data: transmits ASCII data to the computer
4	DSR	I	Data Set Ready
5	DTR	O	Data Terminal Ready
6	RTS	O	Request To Send
7	AGND		Analog Ground
8	DCD	I	Carrier Detect
9	SCLK	O	Clock for Serial Bus (Clock Rate 4 MHz)
10	TDATA	O	Data line for serial bus
11	REC2	O	Recorder Output with Artificial Instrument
12	DGND		Digital Ground
13	+5 V		Supply for external accessory, $I_{max} = 0.1 \text{ A}$
14	PORT1	O	User Port Data 1
15	PORT2	O	User Port Data 2
16	PORT3	O	User Port Data 3
17	PORT4	O	User Port Data 4
18	PORT5	O	User Port Data 5
19	PORT6	O	User Port Data 6
20	CTS	O	Clear To Send
21	Strobe	O	Control signal for transfer of data to register
22	RI	I	Ring indicator
23	REC1	O	Recorder Output without Artificial Instrument
24	AGND		Analog ground
25	+12 V	O	Supply voltage for accessories, $I_{max} = 0.1 \text{ A}$

Fig. 3-29 Assignment of the user interface X 37 (USER INTERFACE)

3.2.6.3.1 Serial Interface (RS-232 C)

The serial RS-232-C-interface is provided for loading the instrument firmware. It allows the loading of new firmware versions using personal computer compatible with IBM-AT via its serial interface without opening the instrument. For more details refer to section 4.

The connection to the PC is established via a cable with a 25-contact connector (to the ESPC) and a 9-contact connector (to the PC), which is included in the ESPC-service kit (cf. Specifications, Recommended Accessories). It is also possible to use an adaptor from 25-contact to 9-contact that is commercially available, as the pin assignment of the ESPC is in accordance with the standard. The following table contains the pin assignment of the serial RS-232C-interface:

Table 3-11

Pin	Signal	I/O	Meaning
2	RxD	I	Received Data: transmits ASCII data from the computer to the receiver
3	TxD	O	Transmitted Data: transmits ASCII data to the computer
4	$\overline{\text{DSR}}$	I	Data Set Ready
5	$\overline{\text{DTR}}$	O	Data Terminal Ready
6	$\overline{\text{RTS}}$	O	Request To Send:
8	DCD	I	Carrier Detect
20	CTS	O	Clear To Send

3.2.6.3.2 TTL-Switching Outputs

Six port lines are provided for the control of external devices such as Artificial Mains Networks ESH2-Z5 and ESH3-Z6 or for switching antennas via external relays (Spec. Func 18). Thus the phases and the reference ground are switched over. The level corresponds to that of the TTL-logic (low < 0.4 V, high > 2.0 V). Entry of frequency ranges is described in Section 3.2.4.2.1.

Bedienung:

- ▶ Taste SETUP drücken, und mit der Taste ↓ den Cursor auf *User Port* setzen.
- ▶ Mit einer der Enter-Tasten ins User Port-Menü wechseln.
- ▶ Mit der Taste ↑ bzw. ↓ den gewünschten Schalausgang anwählen, und mit einer der Enter-Tasten auf *HIGH* oder *LOW* setzen.

Table 3-12

Anschiuß	Signal	Bedeutung	Funktion
12	GND	Ground	---
14	PORT 1	User port 1	High: antenna active in frequency range 1
15	PORT 2	User port 2	High: antenna active in frequency range 2
16	PORT 3	User port 3	High: antenna active in frequency range 3
17	PORT 4	User port 4	High: antenna active in frequency range 4
18	PORT 5	User port 5	High: antenna active in frequency range 5
19	PORT 6	User port 6	Switching output controlled via IEC bus

3.2.6.3.2 Trigger Input

The trigger input (USER PORT, pin 1) allows to start measurements depending on an external event. This input is activated using the special functions 51 and 52 (cf. section 3.2.3.12). The input is triggered by edges and requires TTL-level (low < 0.4 V, high > 2.0 V).

3.2.6.3.3 Analog Voltages

There are two outputs (REC1 and REC2) available for logging the analog display voltage using a YT-recorder or for observing the shape of the display voltage using an oscilloscope. Both outputs provide the analog display voltage. The output REC2 contains a low-pass with the time constant 100 ms, which corresponds to the meter time constant according to CISPR 16. The outputs provide a voltage which is dB-linear and feature the scaling 50 mV/dB in the 60-dB operating range and 100 mV/dB in the 30-dB operating range. Full scale deflection on the display instrument corresponds to a voltage of 3.75 V at the analog outputs (pin assignment cf. figure 3-29).

3.2.6.3.4 Supply Voltages

For supplying external devices with low current consumption, the device-internal supply voltages + 5 V (5.0 V to 5.5 V) and + 12 V (10.8 to 15 V) are brought out. The current-carrying capacity is 100 mA for both outputs. The receiver automatically switches off in the case of a short-circuit.

Table 3-14

Pin	Signal	Meaning
13	+ 5V	5-V supply
24	AGND	Analog ground
25	+ 12V	12-V supply

3.2.6.4 Printer Interface

The 15-contact socket PRINTER INTERFACE at the rear panel of the receiver is provided for connecting a printer. The interface is compatible with the CENTRONICS-interface. A special cable can be supplied for connecting the interface to the printer (EZ11-type, cf. Specifications, Recommended Accessories):

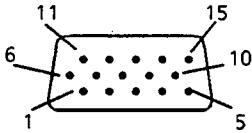

Pin	Signal	I/O	Meaning
1	$\overline{\text{PRISTB}}$	O	Pulse for transmitting a data byte
2	PRIDAT2	O	Data line 2
3	PRIDAT5	O	Data line 5
4	$\overline{\text{PRIACK}}$	I	Indicates that the printer is ready for reception of the next byte
5	PRISEL	I	The printer supplies HIGH, when it is selected
6	PRIDAT0	O	Data line 0
7	PRIDAT3	O	Data line 3
8	PRIDAT6	O	Data line 6
9	PRIBUSY	I	Signal HIGH, when the printer is busy
10	PRIRES	O	Initialization of the printer (active LOW)
11	PRIDAT1	O	Data line 1
12	PRIDAT4	O	Data line 4
13	PRIDAT7	O	Data line 7
14	AGND		Analog Ground
15	$\overline{\text{PRIFAU}}$	I	Fault of printer (active Low)

Fig. 3-30 Pin assignment of the Printer Interface

3.2.6.5 IEC-Bus

The ESPC is equipped with a remote control interface according to the standard IEC 625. It is connected to the socket at the rear panel of the instrument.

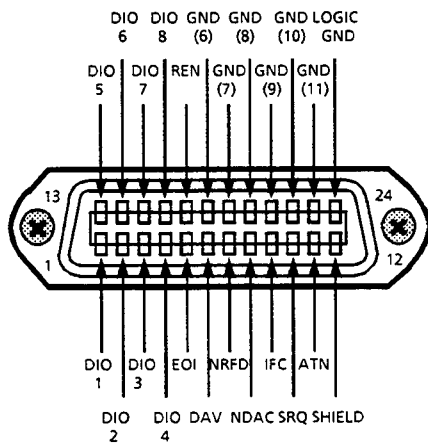

Pin	Signal	Pin	Signal
1	Data I/O1	13	Data I/O5
2	Data I/O2	14	Data I/O6
3	Data I/O3	15	Data I/O7
4	Data I/O4	16	Data I/O8
5	EOI	17	REN
6	DAV	18	Ground
7	NRFD	19	Ground
8	NDAC	20	Ground
9	IFC	21	Ground
10	SRQ	22	Ground
11	ATN	23	Ground
12	Shield	24	Logic Ground

Fig. 3-31 Pin assignment of the IEC-bus socket

The characteristics of the interface can be learnt from the IEC-standard. The interface functions and setting commands are described in section 3.3.

Note: *In order to achieve a long operating time per battery charge, the IEC-bus interface is switched off during operation with internal battery. If remote control via IEC-bus is desired with battery operation, it can be switched on using the Special Function 11 (cf. section 3.2.3.12).*

3.2.6.6 Connecting a Keyboard

A 5-contact DIN*-socket is provided for connecting a keyboard. Due to its low emitted interference it is recommended to use the keyboard PSA-Z1 (order no. 1009.5001.31). It is however also possible to use any other MF-compatible keyboard.

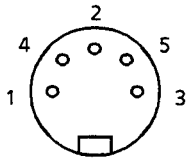

Pin	Signal
1	Keyboard Clock
2	Data
3	free
4	ground
5	+ 5-V supply

Fig. 3-32 Assignment of the KEYBOARD socket

*) German Industrial Standard

Tabelle 3-14 Funktionstasten F1 bis F12 auf einer externen Tastatur

Key	F1	F2	F3	F4
	Frequency	IF Bw	Detektor	Meas time
Shift	Print	Plot	Title	Rep Setting
Ctrl	Step	Coarse	Fine	Lock

Key	F5	F6	F7	F8
	Auto	Att down	Att up	Mode
Shift	Setup	Transducer		Selftest
Ctrl	Stepsize		Cal Short	Cal Total

Key	F9	F10	F11	F12
	Demod	Generator	Preamp	Op Range
Shift	Scan	Limits	Options	Run / Stop
Ctrl	Specfunc	Save	Recall	

3.3 Remote Control (IEC-Bus)

The test receiver ESPC features an IEC-bus device as standard equipment. The interface complies with the standards IEEE 488.1 and IEC 625-1. The ESPC furthermore considers the standard "IEEE Standard Codes, Formats, Protocols, and Common Commands ANSI/IEEE Std 488.2 - 1987" also approved of by the IEC commission. The standard IEEE 488.2 describes common commands, data transfer formats, terminator definitions, protocols of passing control. Program examples in R&S-BASIC and Quick BASIC can be found in section 3.5.

The IEC-bus connection socket is situated on the rear panel of the ESPC. It is a 24-contact Amphenol connector complying with the IEEE 488 standard (cf. section 3.2.6.7). The interface contains three groups of bus lines:

1. Data bus with the 8 lines DIO1 to DIO8

Data transmission is bit-parallel and byte-serial with the characters in ISO 7-bit code (ASCII-code), cf. table 3-18.

2. Control bus with 5 lines

ATN (Attention)

becomes active Low when addresses, universal commands or addressed commands are transmitted to the connected devices.

REN (Remote Enable)

enables the device to be switched to the remote status.

SRQ (Service Request)

enables a connected device to send a Service Request to the controller by activating this line.

IFC (Interface Clear)

can be activated by the controller in order to set the IEC interfaces of the connected devices to a defined status.

EOI (End or Identify)

can be used to identify the end of data transfer and is used with a parallel poll.

3. Handshake bus with 3 lines

It is used to control the data transfer timing via the IEC-bus.

NRFD (Not Ready For Data)

an active Low on this line signals to the talker/controller that at least one of the connected devices is not ready to accept data present on the data bus.

DAV (Data Valid)

is activated by the talker/controller shortly after a new data byte has been applied to the bus and signals that this data byte is valid.

NDAC (Not Data Accepted)

is held at active Low until the connected devices have accepted the data byte present on the bus.

According to the IEC 625-1 standard, devices controlled via the IEC bus can be equipped with different interface functions. The following interface functions are applicable to the ESPC:

Table 3-14 Interface functions

Control characters	Interface functions
SH1	Source Handshake function, full capability
AH1	Acceptor Handshake, full capability
L4	Listener function, full capability, unaddress if MTA
T6	Talker function, full capability, unaddress if MLA
SR 1	Service Request function, full capability
PP1	Parallel Poll function, full capability
RL1	Remote/Local switchover function, full capability
DC1	Device Clear function, full capability
DT1	Device Trigger function, full capability
C1 C2 C3 C11	Controller function, (system controller) transmits IFC transmits REN takes and passes control

3.3.1 Setting the Device Address

The IEC-bus address of the receiver is set in the SETUP menu (cf. section 3.2.4.2.1). The address can be entered using the numeric keys in the range from 0 to 30 and remains stored in the non-volatile memory when the test receiver is switched off. The ESPC is set to address 18 (upon delivery, cold start or firmware update).

The controller uses the IEC-bus address to address the ESPC as IEC-bus talker or -listener. "Talk Only" is not provided in the case of the ESPC.

3.3.2 Local / Remote Switchover

The ESPC is always in the "Local" state at turn-on (manual operation). If the ESPC is addressed as Listener by a controller (e.g. using the R&S-BASIC commands "IECOUT" or "IECLAD"), the test receiver enters the Remote state and remains in this state after data transfer has been completed. This is indicated by the "REMOTE" LED on the front panel.

Note: *If the ESPC is supplied via internal battery, the IEC bus is switched off following switch-on to reduce power consumption. The IEC bus can be switched on at any time using special function 11.*

In this mode the receiver cannot be operated manually via the front panel. Rotary knob and keys (with the exception of the "LOCAL" key) are disabled, no menu is displayed. There are two methods to return to the LOCAL state:

- by the addressed command "Go To Local" (GTL) from the controller.
- by pressing the LOCAL key.
Data output from the controller to the ESPC should be stopped before by pressing the LOCAL key, as otherwise the ESPC will immediately enter the Remote state again. The LOCAL key can be disabled by the universal command Local Lockout (LLO) sent by the controller in order to prevent undesired switchover to the Local state. Returning to local mode is possible by way of GTL. The Local Lockout function is again effective when re-entering the Remote state. Activation of the Remote Enable line (REN) by the controller definitely renders LLO ineffective. In R&S-BASIC a combination of the commands IECNREN and IECREN, for example, may be used.

3.3.3 Interface Messages

This group of messages are transmitted to a device via the eight data lines by the controller where the ATN-line is active, i.e low. Only active controllers are able to transmit interface messages. Differentiation is made between universal commands and addressed commands.

3.3.3.1 Universal Commands

Universal commands act, without previous addressing, on all devices connected to the IEC-bus.

Table 3-15 Universal commands

Command	Basic command with R&S controllers	Function
DCL (Device Clear)	IECDCL	Aborts processing of the currently received commands and sets the command processing software to a defined initial status. This command does not affect the device settings.
LLO (Local Lockout)	IECLLO	The LOCAL key is disabled.
SPE (Serial Poll Enable)	IECSPE	Ready for serial poll.
SPD (Serial Poll Disable)	IECSPD	End of serial poll.

3.3.3.2 Addressed Commands

The addressed commands act only on those devices previously addressed as listeners by the controller (e.g. R&S-BASIC command "IECLAD").

Table 3-16 Addressed commands

Command	Basic command with R&S controllers	Function
SDC (Selected Device Clear)	IECSDC	Aborts processing of the currently received commands and sets the command processing software to a defined initial status. This command does not affect the device settings.
GTL (Go to Local)	IECGTL	Change to Local state (manual operation)
GET (Group Execute Trigger)	IECGET	Start of level measurement

A device is addressed as listener until it is unaddressed by the controller (R&S-BASIC command: IECUNL).

Table 3-17 ASCII/ISO- and IEC-character set

Control characters					Numbers and special characters				Upper-case letters				Lower-case letters				
0	NUL		16	DLE		32	SP	48	0	64	@	80	P	96	`	112	p
1	SOH	GTL	17	DC1	LLO	33	!	49	1	65	A	81	Q	97	a	113	q
2	STX		18	DC2		34	"	50	2	66	B	82	R	98	b	114	r
3	ETX		19	DC3		35	#	51	3	67	C	83	S	99	c	115	s
4	EOT	SDC	20	DC4	DCL	36	\$	52	4	68	D	84	T	100	d	116	t
5	ENQ	PPC	21	NAK	PPU	37	%	53	5	69	E	85	U	101	e	117	u
6	ACK		22	SYN		38	&	54	6	70	F	86	V	102	f	118	v
7	BEL		23	ETB		39	'	55	7	71	G	87	W	103	g	119	w
8	BS	GET	24	CAN	SPE	40	(56	8	72	H	88	X	104	h	120	x
9	HT	TCT	25	EM	SPD	41)	57	9	73	I	89	Y	105	i	121	y
10	LF		26	SUB		42	*	58	:	74	J	90	Z	106	j	122	z
11	VT		27	ESC		43	+	59	;	75	K	91	[107	k	123	{
12	FF		28	FS		44	,	60	<	76	L	92	\	108	l	124	
13	CR		29	GS		45	-	61	=	77	M	93]	109	m	125	}
14	SO		30	RS		46	.	62	>	78	N	94	^	110	n	126	~
15	SI		31	US		47	/	63	? / UNL	79	O	95	-	111	o	127	DEL
Addressed commands			Universal commands		Listener addresses				Talker addresses				Secondary addresses and commands				

Code for control characters:

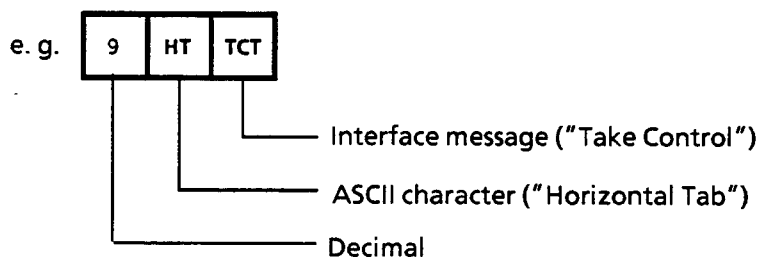

3.3.4 Device Messages

Device messages (acc. to IEC 625-1) are transmitted via data lines, in which case the ATN line is not active, i.e. High. The ASCII code (ISO 7-bit code) is used. A differentiation is made between:

- Device-independent commands (common commands acc. to IEC 625, cf. section 3.3.4.3)
- Device-specific commands (cf. section 3.3.4.4)

Commands with a "?", such as FREQUENCY? are referred to as "query messages" and request the ESPC to output the respective value where the same format is used as in the command table. The data and values read in by the controller can thus be directly returned to the ESPC. In this example the output of the test receiver may be "FREQUENCY 9000" where the basic unit (here: Hz) is always valid.

3.3.4.1 Commands Received by the Test Receiver in Listener Mode (Controller to Device Messages)

Input buffer:

All the commands and data sent to the receiver are stored temporarily in the 4096-byte input buffer. It is however also possible to process longer command lines in which case the part received before is processed internally in the receiver.

Terminators:

Each command line must be ended by a terminator (exception: continued command lines). Permissible terminators are:

- <New Line> (ASCII-Code 10 decimal)
- <End> (EOI line active) together with the last character of the command line or the character <New Line>.

The terminator is set using the device-specific commands TERMINATOR LFEOI - <New Line> together with <EOI> - and TERMINATOR EOI - only <EOI> for transmission of binary data blocks (cf. section 3.3.4.4).

As the character <Carriage Return> (ASCII code 13 decimal) is permissible as a filler without effect before the terminator, the combination of <Carriage Return> and <New Line> that is for example sent by the R&S-Controller PCA is also permissible.

All IEC-bus controllers from Rohde & Schwarz send terminators accepted by the test receiver as standard. A command line may require more than one line on the controller screen since it is only limited by the terminator. Most IEC-bus controllers add automatically the terminator to the data transmitted.

Separators:

A command line may contain several commands (program message units) when separated from each other by a semicolon (;).

Command Syntax:

A command may consist of the following parts:

- Only a header
Example: *RST
- Combination of headers
Example: CALIBRATION:SHORT
- Header and question mark ("query")
Example: UNIT?

These commands request the test receiver to transfer the desired data to its output buffer. These data can be read in by the controller as soon as the device will be addressed as a talker.

- Header and numeric value
Examples: MEAS:TIME 50 MS
 FREQUENCY 1.045E2

According to the IEC-bus standard IEEE 488.2, the header and numeric value must be separated at least by one space (ASCII code 32 decimal). In the case of device-specific commands, the number can be supplemented by a unit (e.g. "MHz", "S", etc.).

- Header and mnemonic
Example: DETECTOR AVERAGE
- Header and string
Example: LIMIT:TEXT 'VFG 1046'
 or LIMIT:TEXT "VFG 1046"

The two different types of notation allow to use them in different programming languages without any difficulties. The character ' is preferably used in R&S-BASIC.

The headers and their meanings are explained in section 3.3.4.4. Lower-case letters are equivalent to upper-case letters. Thus units can be used in the usual form, e.g. dBm instead of the notation using upper-case letters "DBM".

The IEC-bus syntax makes it possible to insert additional spaces at the following points:

- at the beginning of a header
- between header and numeric value, mnemonic or string
- between numeric value and unit
- before and after commas (,) and semicolons (;)
- before the terminator.

Numeric values:

Only decimal numbers are allowed as numeric values, the following notations are permissible:

- With and without sign
Example: 10, +10, -10
- With and without decimal point, any position of the decimal point is permissible.
Example: 1.234 -200.5 .123

- With or without exponent to base 10, "E" or "e" can be used as the exponent character.
Example: 451 451E-3 +4.51e-2
- The exponent is permissible with or without a sign, a space is also permissible instead of the sign
Example: 1.5E+3 1.5e-3 1.5E 3
- Specification of the exponent only (e.g. E-3) is not permissible, 1E-3 is correct.
- Leading zeros are permissible in the mantissa and exponent.
Example: +0001.5 -03.7E-03
- The length of the numeric value, including the exponent, may be up to 20 characters. The number of digits for the mantissa and exponent is only limited by this condition. Digits that exceed the resolution of the device are rounded up or down; they are, however, always considered for the order of magnitude.

Command line

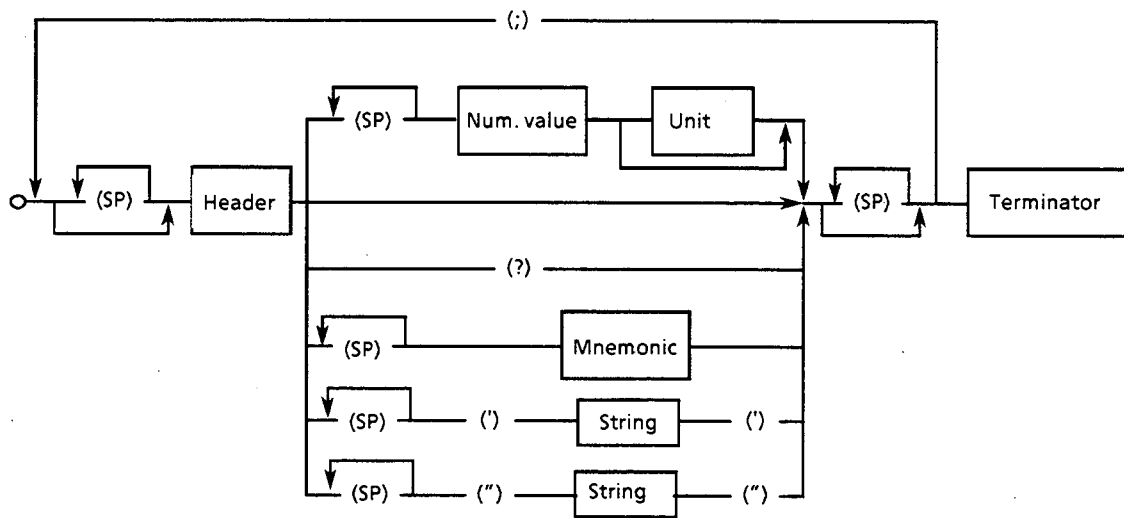

Numeric value

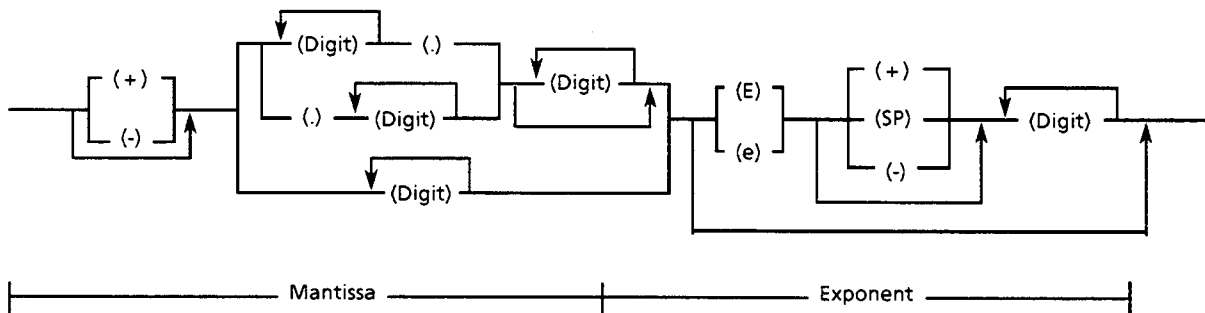

SP: Any character with ASCII code 0 to 9 and 11 to 32 decimal, especially space.

Fig. 3-33 Syntax diagram of a command line

3.3.4.2 Messages Sent by the Test Receiver in Talker Mode (Device to Controller Messages)

The ESPC sends messages via the IEC-bus, if it

- has been requested to make data available in its output buffer by one or more query messages with a question mark within one command line,
- indicates by setting bit 4 in the status byte (Message Available) that the requested data are now available in the output buffer,
- has been addressed as a talker (e.g. by the R&S-BASIC command "IECIN").

It is necessary for the command line with the data requests to be transmitted directly before talker addressing; if another command line is present in between, the output buffer is cleared and bit 2 in the event status register is set (query error; cf. section 3.3.5).

The output buffer has a capacity of 4096 byte.

A query message is formed by adding a question mark to the respective header, e.g. FREQUENCY?.

If the ESPC is addressed as a talker directly after the query message, the bus handshake is disabled until the requested data are available. This may take several seconds since e.g. with *CAL? a calibration is performed before addressing. In this case it is more useful to wait for the MAV-bit (cf. section 3.3.5).

The syntax for data output is exactly the same as for commands received by the ESPC. <New Line> together with END (EOI active) is always used as terminator. The transmission of header and numeric value enables the messages sent by the ESPC as a talker to be returned unchanged from the controller to the test receiver. Thus a setting performed via the front panel can be read, stored in the controller and returned later to the receiver via the IEC-bus.

Notes: *If the ESPC receives several query messages, it also returns several messages within one line separated by semicolons (;).*

Several numeric values (day, month and year) can be sent as a reply to certain query messages (e.g. SYSTEM:DATE?). They are separated by commas (,).

Header and numeric values are always separated by spaces. Headers only consist of upper-case letters and the characters ":" "_" and "".*

The messages sent by the ESPC do not contain units. In the case of physical variables, the numeric values are referred to the basic unit (cf. section 3.3.4.4).

Output of the header can be switched on or off using the commands "HEADER ON" and "HEADER OFF".

Output message line

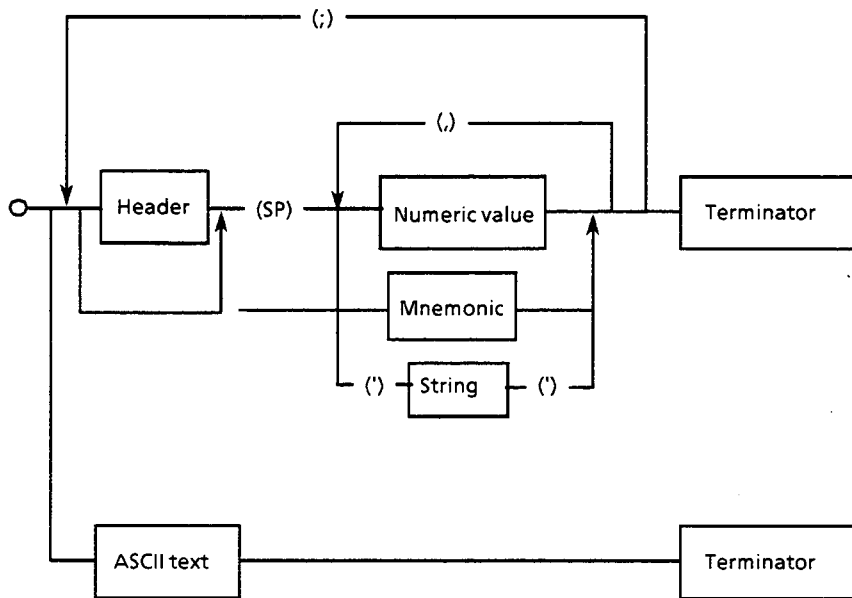

Numeric value

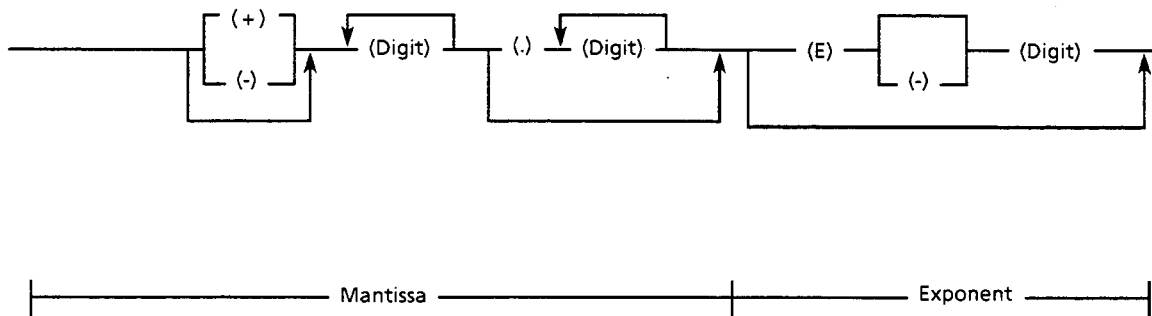

Fig. 3-35 Syntax diagram of messages sent by the receiver

3.3.4.3 Common Commands

The common, device-independent commands are grouped as follows:

- Commands referring to the Service Request function with the associated status and mask registers
- Commands for device identification
- Commands referring to the Parallel Poll function
- Commands for triggering sequences
- Commands for device-internal sequences (reset, calibrate, self-test) and for synchronizing sequences.

The common commands are taken from the new IEEE488.2 (IEC 625-2) standard. This ensures that these commands have the same effect in different devices. The headers of these commands consist of an asterisk "*" followed by three letters.

Table 3-18 Device-independent commands (common commands) received by the EPC

Command	Numeric value/ Range	Meaning
*RST	---	<p>Reset</p> <p>The receiver is set to its default status as it is possible with RCL 0 on the front panel.</p> <p>This command does not change the status of the IEC-bus interface, the set IEC-bus address, the mask registers of the Service Request function and the output buffer.</p>
*PSC	0 to 65535	<p>Power On Status Clear (reset on power-up)</p> <p>If the numeric value is higher than 0, the Service Request Enable mask register (SRE) and the Event Status Enable mask register (ESE) are cleared during power-up.</p> <p>If the value is equal to 0, the registers mentioned above retain their contents when the device is switched on and off. Bit 7 in the Event Status register is set when switching on the test receiver. If the Event Status and Service Request Enable register have the appropriate configuration prior to switch-off, a Service Request may be enabled (cf. section 3.3.5).</p>
*OPC	---	<p>Operation Complete (ready-signal)</p> <p>Sets bit 0 (Operation Complete) in the Event Status register (ESR), if all previous commands have been processed.</p>
*CLS	---	<p>Clear Status.</p> <p>Sets the status registers ESR and STB to zero. The mask registers of the Service Request function (ESE and SRE) are not changed.</p> <p>This command does not change the status of the IEC-bus interface, the set IEC-bus address, the mask registers of the Service Request function and the output buffer</p>
*ESE	0 to 255	<p>Event Status Enable</p> <p>The Event Status Enable mask register is set to the specified value which is interpreted as a decimal number (see section 3.3.5)</p>

Command	Numeric value /Range	Meaning
*SRE	0 to 255	<p>Service Request Enable</p> <p>The Service Request Enable mask register is set to the specified value which is interpreted as a decimal number (cf. section 3.3.5).</p>
*PRE	0 to 65535	<p>Parallel Poll Enable</p> <p>The Parallel Poll Enable mask register is set to the specified value which is interpreted as a decimal number.</p>
*PCB	0 to 30	<p>Pass Control Back</p> <p>The numeric value specifies the address of the controller to which the IEC-bus control is to be returned after completion of the plotter output.</p>
*TRG	---	<p>Trigger</p> <p>Level measurement of the ESPC is re-started, a current measurement is aborted. This command has the same function as the message GET. Measurement values are however not made available for output as the IEC-bus standard permits output only following a query command.</p> <p>The device-specific commands are provided for this purpose:</p> <ul style="list-style-type: none"> ● LEVEL:LASTVALUE? the value of the last level measurement, which was triggered by e.g. *TRG, is made available in the output buffer. ● LEVEL? level measurement is started and the measured value is subsequently made available in the output buffer. ● LEVEL:CONTINUE? the value of the last level measurement is made available in the output buffer and a new level measurement is started. Same function as a sequence consisting of the commands LEVEL:LASTVALUE? and *TRG.
*RCL	0 to 9	<p>Recall</p> <p>Recalls a stored device setting (1 to 9). *RCL 0 sets the ESPC to its default status analog to the command *RST. The command has the same function as the RCL key.</p>
*SAV	1 to 9	<p>Save</p> <p>Saves a current device setting or a report configuration. Same function as the SAVE key.</p>
*WAI	---	<p>Wait To Continue</p> <p>Only processes the subsequent commands when all previous commands have been completely executed (cf. section 3.3.7).</p>

Table 3-19 Common Commands leading to data output

Command	Output message Data value		Meaning
	No. of digits	Range	
*IDN?	30	alphanumeric	Identification Query The following identification text is sent via the IEC-bus as a reply to the *IDN? command (always without header). Example: Rohde&Schwarz, ESPC,0,1.00, 2.00 Rohde&Schwarz = Manufacturer ESPC = Model 0 = reserved for serial number, (not used with ESPC) 1.00 = Firmware version (for example) 2.00 = OTP firmware version
*PSC?	1	0 or 1	Power On Status Clear Query Reading the status of the Power On Clear flag (cf. *PSC)
*OPC?	1	0 or 1	Operation Complete Query (ready message) The message "1" is entered into the output buffer and bit 4 (message available) is set in the status byte when all previous commands have been completely executed. Bit 0 (operation complete) is also set in the Event Status register (cf. section 3.3.7).
*ESR?	1 to 3	0 to 255	Event Status Register Query The contents of the Event Status register is output in decimal form and the register then set to zero.
*ESE?	1 to 3	0 to 255	Event Status Enable Query The contents of the Event Status Enable mask register is output in decimal form. The gap in the range of values results from the fact that bit 6 (rsv) cannot be set. The value results from ORing of the other bits (cf. fig. 3-37).
*STB?	1 to 3	0 to 255	Status Byte Query The contents of the status byte is output in decimal form.
*SRE?	1 to 3	0 to 63 and 128 to 191	Service Request Enable Query The contents of the Service Request Enable mask register is output in decimal form. The gap in the range of values results from the fact that bit 6 (rsv) cannot be set. The value results from ORing of the other bits (cf. fig. 3-37).
*TST?	1 to 3	s. Tab. 3-21	Self-Test Query A device self-test is executed. The output value "0" indicates proper termination of the self-test. Values > "0" signal faults in the respective module(s).
*IST?	1	0 or 1	Individual Status Query Reads the current device status (Parallel Poll message to IEEE488.1). "0" means the current status is FALSE, "1" means TRUE.
*PRE?	1 to 3	0 to 255	Parallel Poll Enable Query The contents of the Parallel Poll register is output in decimal form.
*STB?	1 to 3	0 to 255	Status Byte Query The contents of the status byte is output in decimal form.
*CAL?	1 to 3	s. Tab. 3-21	Calibration Query The receiver is calibrated. If the calibration is completed successfully, "0" is output as a reply; otherwise a number between 25 and 167 the meaning of which can be learnt from table 3-21 is output.
*OPT?	1 to 15	alphanumeric	Option Query The configuration of the test receiver fitted with options ESPC-B2 and ESPC-B3 can be queried.

Table 3-20 Meaning of the Error Messages during Calibration

Output value	Meaning
06	IF bandwidth calibration error
25	The gain at the reference frequency 1 MHz cannot be controlled.
65	The IF gain switch is defective so that its gain error cannot be corrected.
81	The 30-dB operating range is defective and cannot be used.
83	The 60-dB operating range is defective.
103	Quasi-peak weighting in Band A is defective.
105	Quasi-peak weighting in Band B is defective.
107	Quasi-peak weighting in Band C is defective.

Tabelle 3-20a A filter range of the preselection is defective; frequency response at the respective frequency is more than 6 dB

Output value	Frequency
129	100 kHz
131	200 kHz
133	500 kHz
135	1 MHz
137	1,8 MHz
139	1,9 MHz
141	2,4MHz
143	2,9 MHz
145	3,9MHz
147	5,9 MHz
149	7,9 MHz
151	8,4 MHz
153	8,9 MHz
155	9,9 MHz
157	14,9 MHz
159	19,9 MHz
161	24,9 MHz
163	25,4 MHz
165	25,9 MHz
167	27,9 MHz
169	29,4 MHz
171	29,9 MHz
173	30,4 MHz
175	30,9 MHz
177	40,9 MHz
179	50,9 MHz
181	60,9 MHz
183	70,9 MHz
185	79,9 MHz

Output value	Frequency
187	80,4 MHz
189	90,9 MHz
191	100,9 MHz
193	110,9 MHz
195	120,9 MHz
197	130,9 MHz
199	140,9 MHz
201	150,9 MHz
203	160,9 MHz
205	170,9 MHz
207	180,9 MHz
209	190,9 MHz
211	199,9 MHz
213	200,4 MHz
215	210,9 MHz
217	220,9 MHz
219	230,9 MHz
221	240,9 MHz
223	250,9 MHz
225	260,9 MHz
227	270,9 MHz
229	280,9 MHz
231	290,9 MHz
233	300,9 MHz
235	310,9 MHz
237	320,9 MHz
239	330,9 MHz
241	340,9 MHz
243	350,9 MHz

Output value	Frequency
245	360,9 MHz
247	370,9 MHz
249	380,9 MHz
251	390,9 MHz
253	400,9 MHz
255	410,9 MHz
257	420,9 MHz
259	430,9 MHz
261	440,9 MHz
263	450,9 MHz
265	460,9 MHz
267	470,9 MHz
269	480,9 MHz
271	490,9 MHz
273	499,9 MHz
275	500,4 MHz
277	510,9 MHz
279	520,9 MHz
281	530,9 MHz
283	540,9 MHz
285	550,9 MHz
287	560,9 MHz
289	570,9 MHz
291	580,9 MHz
293	590,9 MHz
295	600,9 MHz
297	610,9 MHz
299	620,9 MHz
301	630,9 MHz

Output value	Frequency
303	640,9 MHz
305	650,9 MHz
307	660,9 MHz
309	670,9 MHz
311	680,9 MHz
313	690,9 MHz
315	700,9 MHz
317	710,9 MHz
319	720,9 MHz
321	730,9 MHz
323	740,9 MHz
325	750,9 MHz
327	760,9 MHz
329	770,9 MHz
331	780,9 MHz
333	790,9 MHz
335	800,9 MHz
337	810,9 MHz
339	820,9 MHz
341	830,9 MHz
343	840,9 MHz
345	850,9 MHz
347	860,9 MHz

Output value	Frequency
349	870,9 MHz
351	880,9 MHz
353	890,9 MHz
355	900,9 MHz
357	910,9 MHz
359	920,9 MHz
361	930,9 MHz
363	940,9 MHz
365	950,9 MHz
367	960,9 MHz
369	970,9 MHz
371	980,9 MHz
373	990,9 MHz
375	999,9 MHz
377	1000,4 MHz
379	1050,9 MHz
381	1100,9 MHz
383	1150,9 MHz
385	1200,9 MHz
387	1250,9 MHz
389	1300,9 MHz
391	1350,9 MHz
393	1400,9 MHz

Output value	Frequency
395	1450,9 MHz
397	1500,9 MHz
399	1550,9 MHz
401	1600,9 MHz
403	1650,9 MHz
405	1700,9 MHz
407	1750,9 MHz
409	1800,9 MHz
411	1850,9 MHz
413	1900,9 MHz
415	1959,9 MHz
417	1960,9 MHz
419	2000,9 MHz
421	2050,9 MHz
423	2100,9 MHz
425	2150,9 MHz
427	2200,9 MHz
429	2250,9 MHz
431	2300,9 MHz
433	2350,9 MHz
435	2400,9 MHz
437	2450,9 MHz
439	2499,9 MHz

Table 3-21 Meaning of the Return Values of the Self-test

Value	Meaning
0	The self-test was completed without any error
1	+ 5-V-supply voltage out of tolerance
2	+ 10-V-supply voltage out of tolerance
3	-10-V-supply voltage out of tolerance
4	+ 28-supply voltage out of tolerance
15	Any other defect of the module CPU-board
18	Component of the real-time clock is defective
19	Serial bus is defective
99	Synthesizer is defective
100	Front end is defective
106	IF selection board is defective
107	2nd mixer is defective
111	Detector board is defective

3.3.4.4 Device-specific Commands

The query messages are identified by an added "?". They enable the ESPC to transmit device settings or measured values to the controller. The structure of the data output format is the same as that of data input thus making it possible that the data read by the controller can be returned to the test receiver without further processing in the controller. If no unit is stated, the respective basic unit is used (Hz, s, dB, %). The used syntax is in accordance with the new standard "IEEE 488.2" that has been valid since 11/87. Program examples concerning IEC-bus programming are stated in section 3.5.

Note: When reading the data in the controller please do make sure that the settings of the terminators are correct. The R&S-BASIC command for ASCII-texts is IEC TERM 10; for binary data IEC TERM 1.

Some headers can be abbreviated. The shortest possible notation is marked by bold letters in the tables 3-23 to 3-27

Table 3-22 Receiver Functions

Command	Data	Unit	Meaning
A TENUATION A TENUATION? :AUTO :AUTO? :MODE :MODE? :ZSD?	0 to 70 dB I NCREMENT D ECREMENT O N O FF L OWNOISE L OWD I STORTION ---	D B --- --- ---	RF-attenuation Auto-range on off Attenuation mode Zero Scale Deflection
B ANDWIDTH:IF :IF?	200 Hz to 120 kHz	H Z K HZ M HZ G HZ	IF-bandwidth of the receiver
C ALIBRATION:: C ORRECTION	O N O FF	---	Considering the calibration correction values during level measurement on/off
D EMODULATION D EMODULATION?	A 3 A 0 F M O FF	---	Demodulation mode
D ETECTOR D ETECTOR?	A VERAGE P EAK Q UAS I PEAK	---	Weighting mode (Detector)

Command	Data	Unit	Meaning
FREQUENCY FREQUENCY?	150 kHz (200 Hz) to 1000 (2500) MHz	HZ KHZ MHZ GHZ	Receiver frequency (The settable range depends on the options fitted)
	INCREMENT DECREMENT		Step up Step down
:STEPSIZE	0 Hz to 1000 (2500) MHz	HZ KHZ MHZ GHZ	Step size of frequency variation
:STEPSIZE?			
:VARIATION :VARIATION?	STEP COARSE FINE LOCK	---	Step size of frequency variation using rotary knob
:EXTREF :EXTREF?	ON OFF		Switching on/off external reference
LEVEL?	---	---	Starting a level measurement and making the measured value available
:CONTINUE?	---	--	Making the value of the last level measurement available in the output buffer and starting a new measurement.
:LASTVALUE?	---	---	Making the value of the last level measurement available in the output buffer.
:FORMAT :FORMAT?	ASCII BINARY	---	Measured value output with ASCII characters. Measured value output in binary format.
MEASUREMENT:TIME MEASUREMENT:TIME?	1 ms to 100 s	S Ms	Measuring time
RANGE RANGE?	30 dB 60 dB	DB	Operating range
SPECIALFUNC SPECIALFUNC?	Number, ON/OFF (,Number, ON/OFF...) 0 1 2 10 12 13 16 17 18 20 30 32 33 51 52	---	Special functions: Default setting CISPR-bandwidths Coupled measuring times Background lighting Coding socket Beeper Limit check Transducer check Transducer switch Unit dBm Double measurement modes: Peak + AV Peak + Quasi Peak Quasi Peak + AV External trigger positive edge External trigger negative edge
UNIT?	---	---	Polling the level unit

Table 3-23 RF-analysis

Command	Data	Unit	Meaning
GRID:FREQAXIS GRID:FREQAXIS? :MINLEVEL :MINLEVEL? :MAXLEVEL :MAXLEVEL?	LIN LOG -200 to +200 -200 to +200	--- DB DB	Pitch of axes of the diagram of RF-analysis Minimum level of the diagram of RF-analysis Maximum level of the diagram of RF-analysis
LIMIT LIMIT? :TEXT :TEXT? :DEFINE :DEFINE? :VALUE?	1 to 22 [,ON] 1 to 22 [,OFF] "ASCII text" max. 8 characters Number, Frequency 1, level 1, Frequency 2, level 2,.. n[,limit 1[,limit 2]] n: number of limit lines, 0 to 2 limit 1: 1st limit limit 2: 2nd limit	--- --- HZ KHZ MHZ GHZ DB DB	Selecting and switching on or off limit lines Name of limit line Definition of limit line by frequency-level pairs in increasing order Output of interpolated intermediate values at the current receiver frequency. The value 0 is returned if no limit lines have been switched on.
SCAN SCAN? :RUN :INTERRUPT :CONTINUE :STOP :RANGES :RANGES? :FREQUENCY:START :START? :STOP :STOP? :STEPMODE :STEPMODE? :STEPSIZE :STEPSIZE? :SAVE	1 to 5 1 to 5 Receiver frequency range, Receiver frequency range, LIN LOG 0 to 30 MHz 0 to 100 %	--- --- HZ, KHZ, MHZ, GHZ HZ, KHZ, MHZ, GHZ --- HZ, KHZ, MHZ, GHZ PCT ---	Selection of a partial scan Starting a scan Interrupting a scan Continuing an interrupted scan Stopping a scan Number of scans to be executed Start frequency of partial scan Stop frequency of partial scan Type of step size, the same for all partial scans Step size, in Hz for linear steps, in % for logarithmic frequency switching The scan settings for the start and stop frequency as well as the step size are adopted and checked whether they are consistent using this command. Error messages refer to the previous settings for the partial scan ranges.
:RECEIVER:MEASUREMENT:TIME :MEASUREMENT:TIME? :DETECTOR :DETECTOR?	1 ms to 100 s AVERAGE PEAK QUASISPEAK	S MS ---	Measuring time per measured value of partial scan Weighting mode for partial scan

Command	Data	Unit	Meaning
:BANDWIDTH:IF :BANDWIDTH:IF?	200 Hz to 120 kHz	HZ, KHZ, MHZ, GHZ	IF-bandwidth for partial scan
:ATTENUATION :ATTENUATION?	0 to 70 dB	DB	RF-attenuation for partial scan
:ATTENUATION:AUTO :ATTENUATION:AUTO?	ON OFF	---	Auto-range on/off
:ATTENUATION:MODE :ATTENUATION:MODE?	LOWNOISE LOWDISTORTION	---	IF-attenuation for partial scan
:RANGE :RANGE?	30 dB, 60 dB	DB	Operating range
:DEMODULATION :DEMODULATION?	A3, A0, FM, OFF	---	Demodulation for partial scan
SCAN:OPTION			
:SUBRANGES :SUBRANGES?	8 16 25 50 100 200 400	---	Special functions of RF-analysis Number of subranges
:FASTSCAN	ON OFF	---	Fast Scan with fixed RF attenuation
:MARGIN :MARGIN?	-200 to 200 dB	DB	Margin from acceptance line to limit line
:GATEDSCAN :GATEDSCAN?	ON OFF		Option Gated Scan
:SPECIALSCAN :SPECIALSCAN?	ON OFF		Switching on/off the option Special Scan.
:STYLE :STYLE?	CURVE LINE	---	The measurement curves can be represented either in the form of a closed curve (CURVE) or vertical lines (LINE).
:MAXLEVEL :MAXLEVEL?	-200 to 200 dB	DB	Maximum level of the RF analysis diagram
:MINLEVEL :MINLEVEL?	-200 to 200 dB	DB	Minimum level of the RF analysis diagram
:MAXFREQ :MAXFREQ?	Receiver frequency range	HZ, KHZ; MHZ, GHZ	Maximum frequency of the RF analysis diagram
:MINFREQ :MINFREQ?	Receiver frequency range	HZ, KHZ; MHZ, GHZ	Minimum frequency of the RF analysis diagram
:FREQUENCIES :FREQUENCIES?	Number, Frequency1, Frequency2,	HZ, KHZ; MHZ, GHZ	Frequency values for the option Special Scan; max. 400 values in increasing sequence

Command	Data	Unit	Meaning
SCAN:BLOCK?		---	Output of the scan results in the form of blocks (cf. section 3.3.8 and 3.5)
:COUNT	Number	---	Number of the measured values that are transmitted in a block (the max. number depends on the structure of the data). The value 0 means: measured value output during scan is switched off.
:COUNT?			
	MAX		The output buffer is used to its maximum.
	MAX?		Max. number of block elements.
	SUBRANGE		All the measured values of a subrange are combined to form a block, if the size of the output buffer is sufficient.
:ELEMENT	COMBINED	---	All level values of subrange are combined to form a block, if the size of the size of the output buffer is sufficient.
	TRACE		Only the results of the 400 subrange maxima are transmitted..
	SUBRMAX	---	Es werden nur die Ergebnisse der mit SCAN:OPTION:SUBRANGES definierten Benutzerteilbereiche übertragen.
	DET1		Level values detector 1
	DET2		Level values detector 2
	VALID		Validizy bytes
:FORMAT	ASCII		Output format for scan results (cf. section 3.3.8.)
:FORMAT?	BINARY		
	DUMP		
	SDUMP		
:SIZE?	---		Size of a block element when the measured values are output in the form of bytes (this size is variable for output in ASCII format)
:TEMPLATE?	---		Composition of the individual components of a block element (see chapter 3.3.8).
:RESULTS	--	----	Using this command, scan results can be output at a later date. This command sets the appropriate bits in the ERD register, however does not make available the data in the output buffer.
:CLEAR	----	---	Clearing the memory with measured values

Table 3-25 Transducer

Command	Data	Unit	Meaning
TRANSDUCER	OFF	---	Switching off consideration of transducer factors
:FACTOR :FACTOR?	1 to 22		Selecting a transducer factor
:TEXT :TEXT?	"ASCII text" max. 8 characters		Name of transducer
:DEFINE :DEFINE?	Number Frequency 1, level 1, Frequency 2, level 2, ...	HZ, KHZ, MHZ, GHZ, DB	Definition of transducer factors by frequency-level pairs in increasing order
:VALUE?		---	Output of the interpolated intermediate value at the current receiver frequency
:SELECT :SELECT?	1 to 22		Activating a transducer factor
:UNIT :UNIT?	DB, DBUV, DBUV.M, DBUA DBUA.M, DBPW	---	Unit of transducer factor
:INTERPOLATION :INTERPOLATION?	LIN LOG	---	Linear or logarithmic Frequency axis with transducer interpolation
:SET	1 to 5	---	Selecting a transducer set
:SET:SELECT :SET:SELECT?	1 to 5, NONE		Activating a transducer set
:RANGES :RANGES?	1 to 5		Number of ranges of a transducer set
:NUMBER :NUMBER?	1 to 5		Selecting a transducer set range
:START :START?	9 kHz to 30 MHz	HZ, KHZ, MHZ, GHZ	Start frequency of the selected transducer set range
:STOP :STOP?	9 kHz to 30 MHz	HZ, KHZ, MHZ, GHZ	Stop frequency of the selected transducer set range
:DEFINE :DEFINE?	Number, factor1, factor2, ...	---	Selecting the transducer factors that are combined in a transducer set range.
:UNIT :UNIT?	DB, DBUV, DBUV.M, DBUA DBUA.M, DBPW	---	Unit of the transducer set
:TEXT :TEXT?	"ASCII-text" max. 8 characters		Designation of the transducer set

Table 3-26 Test Report

Command	Data	Unit	Meaning
PLOTTER:START	---	---	Starting plotter output (transfer of controller function is required (cf. section 3.3.9, program examples cf. 3.5).
:SETUP:ADDRESS	0...30	---	Die eingestellte IEC-Bus -Adresse des Plotters wird vom Empfänger für die Ausgabe von Test Reports verwendet. Sie muß sich von der eigenen Adresse des Empfängers unterscheiden.
:SETUP:FORMAT :SETUP:FORMAT?	ON OFF	---	Special scaling of plotter output on/off
:LEFT :LEFT?	-99.999 to 99.999 Plotter-Units	---	Definition of the limits P1 and P2: Left margin
:RIGHT :RIGHT?	-99.999 to 99.999 Plotter-Units	---	Right margin
:TOP :TOP?	-99.999 to 99.999 Plotter-Units	---	Top margin
:BOTTOM :BOTTOM?	-99.999 to 99.999 Plotter-Units	---	Bottom margin
:SETUP:PEN :SETUP:PEN?	ON OFF	---	Selection of pen for plotter output on/off Pen for:
:GRID :GRID?	0 to 8	---	Diagram
:LIMIT :LIMIT?	0 to 8	---	Limit line
:CURVE1 :CURVE1?	0 to 8	---	Measurement curve 1
:CURVE2 :CURVE2?	0 to 8	---	Measurement curve 2
:TEXT :TEXT?	0 to 8	---	Labelling
:SINGLEVALUES :SINGLEVALUES?	0 to 8	---	List of measured values
:DATE :DATE?	0 to 8	---	Data
:CONTENT:DEFAULT :CONTENT:DEFAULT?	ON OFF	---	Elements of a test report: Default setting
:CURVE :CURVE?	ON OFF	---	Measurement curve(s)
:HEADER :HEADER?	ON OFF	---	Header of protocol
:DIAGRAM :DIAGRAM?	ON OFF	---	Diagram
:LIST :LIST?	ON OFF	---	List of measured values
:SCANTABLE :SCANTABLE?	ON OFF	---	Table with scan data
:DATE :DATE?	ON OFF	---	Data
:PAGE :PAGE?	ON OFF	---	Paging

Command	Data	Unit	Meaning
PRINTER PRINTER?	DESKJET LASERJET EPSON24	---	Selection of printer
PRINTER:START :STOP	---	---	Starting printer output Stopping printer output
:CONTENT:DEFAULT :CONTENT:DEFAULT?	ON OFF	---	Elements of a test report: Default setting
:CURVE :CURVE?	ON OFF	---	Measurement curve(s)
:HEADER :HEADER?	ON OFF	---	Header of protocol
:DIAGRAM :DIAGRAM?	ON OFF	---	Diagram
:LIST :LIST?	ON OFF	---	List of measured values
:PAGE :PAGE?	ON OFF	---	Paging
:SCANTABLE :SCANTABLE?	ON OFF	---	Table with scan data
REPORT:HEADER:COMPANY :COMPANY?	"ASCII text" (max.40 characters)	---	texts for the protocol header Test company
:PROGRAM :PROGRAM?	"ASCII text" (max.40 characters)	---	Measurement program
:EUT :EUT?	"ASCII text" (max.40 characters)	---	Equipment under test
:MANUFACTURER :MANUFACTURER?	"ASCII text" (max.40 characters)	---	Manufacturer
:CONDITION :CONDITION?	"ASCII text" (max.40 characters)	---	Operating conditions
:OPERATOR :OPERATOR?	"ASCII text" (max.40 characters)	---	Operator
:SPEC :SPEC?	"ASCII text" (max.40 characters)	---	Test specifications
:REMARK1 :REMARK1?	"ASCII text" (max.60 characters)	---	Remark/comment
:REMARK2 :REMARK2?	"ASCII text" (max.60 characters)	---	Remark/comment

Table 3-26 Common Commands

Command	Data	Unit	Meaning
DISPLAY	ON OFF	---	Switching on/off LCD display on front panel
ERA?	---	---	Event Status register A for specifying the instrument states
ERAE ERAE?	0 to 65535	---	Event Status Enable register A
ERB?	---	---	Event Status register B for indicating synthesizer errors.
ERBE ERBE?	0 to 65535	---	Event Status Enable register B
ERC?	---	---	Event Status register C for specifying the validity of a measured value (section 3.3.8)
ERCE ERCE?	0 to 65535	---	Event Status Enable register C
ERD?	---	---	Event Status register D for specifying the scan states
ERDE ERDE?	0 to 65535	---	Event Status Enable register D
HEADER	ON OFF	---	Switching on and off output of header during poll
LISN LISN? :PHASE :PE	ESH2Z5 ESH3Z5 N L1 L2 L3 GROUNDED FLOATING	---	Selecting the LISN to be controlled Setting the phase; with ESHS3-Z5, N and L1 are permissible only Setting the PE
PRESET	---	---	Resetting of device settings without resetting IEC-bus interface. It corresponds to the function RCL0.
SERVICE:SELFTEST:CALGEN	ON OFF	---	Switching on/off the calibration generator
SYSTEM:ERRORS?	---	---	Polling device-dependent errors (cf. table 3-31)
:DATE :DATE?	dd,mm,yy	---	Date of real-time clock
:TIME :TIME?	hh,mm,ss	---	Time of real-time clock
TERMINATOR	LFEOI EOI	---	Listener terminator: Linefeed (10 decimal) with EOI only EOI for binary data
USERPORT	1 to 6, ON 1 to 6, OFF	---	Setting the user port

Table 3-27 Commands for reading out device configurations

Command	Data	Unit	Meaning
SYSTEM:SETUP	Block data	---	The complete receiver configurations (without transducer and limit lines) can be read out in the form of arbitrary length block data. The data can be reprogrammed in the same form. Block size approx. 12.5 kbyte
:BANDWIDTH?	---	--	Polling the bandwidths of the IF filters integrated in the device. Output in ASCII format; the values are separated by commas.
:RECEIVER :RECEIVER?	Block data	---	Complete receiver settings, such as SYSTEM:SETUP?, however without SAVE or RECALL data can be read out in the form of arbitrary length block data. The data can be reprogrammed in the same form.
:LIMIT :LIMIT?	Block data	---	All limit lines can be read out in the form of arbitrary length block data. The data can be reprogrammed in the same form. Block size approx. 6 kByte
:TRANSDUCER :TRANSDUCER?	Block data	---	The complete transducer factors and transducer sets can be read out in the form of arbitrary length block data. The data can be reprogrammed in the same form. Block size approx. 11 kByte
:LABEL :LABEL?	n,"label",n,"label" n: register "label": name of register	---	The names of the SAVE/RECALL registers can be programmed and queried. After the query, the complete list from 1 to 9 is provided. Any combination can be programmed.

3.3.5 Service Request and Status Register

In line with the new IEC-bus standard the ESPC features the following registers:

- Event Status (ESR)
- Event Status Enable (ESE)
- Status byte (STB)
- Service Request Enable (SRE) and
- Parallel Poll Enable (PRE).

The individual registers have the following meanings:

a) Event Status (ESR):

The Event Status register is an extended version of the status byte used in earlier IEC-bus programmable measuring instruments. In this register the ESPC specifies special events that can be polled by the controller. The respective bit associated with the event or status is set to 1. This bit remains set until it is cleared by reading the Event Status register (command *ESR?) or by one of the following conditions:

- the commands *RST or *CLS
- switching on the power supply voltage (the power-on bit is however set afterwards).

Table 3-28 Meaning of the individual bits of the Event Status register

Bit No.	Meaning
7	Power On Is set when the device is switched on or the power returns following a power failure.
6	User Request This bit is set in the ESR by activating the LOCAL key. If the mask register is set appropriately, the ESPC can generate a Service Request of the controller.
5	Command Error Is set, if one of the following errors is detected during analysis of the received commands: <ul style="list-style-type: none"> ● syntax error ● illegal unit ● illegal header ● a numeric value was combined with a header that requires no subsequent numeric value.
4	Execution Error Is set, if one of the following errors was detected during execution of the received commands: <ul style="list-style-type: none"> ● A numeric value is out of the permissible range (for the respective parameter) ● A received command is incompatible with a currently active device setting.
3	Device-dependent Error Is set, if function errors occur.
2	Query Error Is set, if: <ul style="list-style-type: none"> ● an attempt is being made by the controller to read data from the ESPC when no query command has been issued before ● the data prepared in the output buffer are not read and instead a new command is sent to the ESPC. The output buffer is cleared in this case.
1	Request Control Is set, if the ESPC requires the IEC-bus for control purposes (e.g. plotter).
0	Operation Complete Is set in response to the commands *OPC and *OPC? when all the pending commands have been processed and executed.

b) Event Status Enable (ESE):

This register is set by the controller and forms the mask for the Event Status register. The user can select which bits in the Event Status register also effect the setting of the sum bit ESR (bit 5 in the status byte) thus enabling a service request. The sum bit can only be set when at least one bit in the ESR and the appropriate bit in the ESE are set to 1. The sum bit is automatically cleared, when the condition stated above no longer prevails, e.g. when the bits in the ESR have been cleared by reading out the ESR or, when the ESE-register has been changed. The ESE-register is set to zero upon switching on the power supply when the power-on-status-clear flag is 1 (*PSC 1). The command "*ESE value" serves to set the Event Status Enable mask register where "value" is the contents of the register in decimal form. The current value of the register can be read out again using *ESE?

c) Status byte (STB):

There are the following ways for reading the status byte:

- By way of the command *STB?
The contents is output in decimal form. The status byte is not changed by the readout and the Service Request is not cleared.
- By way of a Serial Poll
The contents is transmitted in binary form. As a result the RQS-bit is set to zero and the Service Request inactive, the remaining bits of the status byte are not changed.

The status byte is cleared:

- By way of the command *CLS, provided that the output buffer is empty.
This command clears the Event Status register (ESR) and the output buffer, thus setting the bit ESR in the status byte to zero. This in turn brings about the clearing of the RQS-bit and the Service Request message.
- By reading the ESR using *ESR? or by setting the ESE to zero using *ESE 0 or by reading the contents of the output buffer.

Table 3-29 Meanings of the individual bits of the status byte

Bit	Bus line	Designation	Meaning
0	DIO 4	ERD	Sum bit of the Event Status register D for specification of the scan states.
1	DIO 5	ERC	Sum bit of the Event Status register C for identification of the validity of a measured value.
2	DIO 6	ERB	Sum bit of the Event Status register B for specifying synthesizer loop errors.
3	DIO 7	ERA	Sum bit of the Event Status register A for specificatio of device states.
4	DIO 6	MAV	Message available, i.e. output buffer is not empty, a message available, e.g. a measured value can be read.
5	DIO 6	ESR	Sum bit of the Event Status register
6	DIO 6	RQS	Request Service

d) Service Request Enable (SRE)

This mask register for the status byte can be set by the controller. The conditions that enable a Service Request can thus be selected. The command SRE 32, for example, sets the mask register such that a Service Request is only generated when the ESR-bit is set. When switching on the power supply the SRE-register is reset (= 0) provided that the Power On Clear flag has the value "1". The SRE-register is not changed by DCL and SDC.

According to the standard, the bit positions 0 to 3 and 7 can be freely assigned for further events. In the case of the ESPC the bits 0 to 3 (ERA, ERB, ERC and ERD) are used to specify certain events and states.

e) Parallel Poll Enable Register

The Parallel Poll Enable register has a capacity of 16 bit. Each bit in this register has a corresponding bit in the status byte or in a device-specific register. If the bit-for-bit operation of the Parallel Poll Enable register with the two ones stated above does not result in 0, the IST-bit (Individual Status) is set to 1. The IST-bit is sent as a reply to a parallel poll of the process controller, thus allowing the identification of the reason for the service request. (The IST-bit can also be read using "*IST?"). Figure 3-41 illustrates the relations.

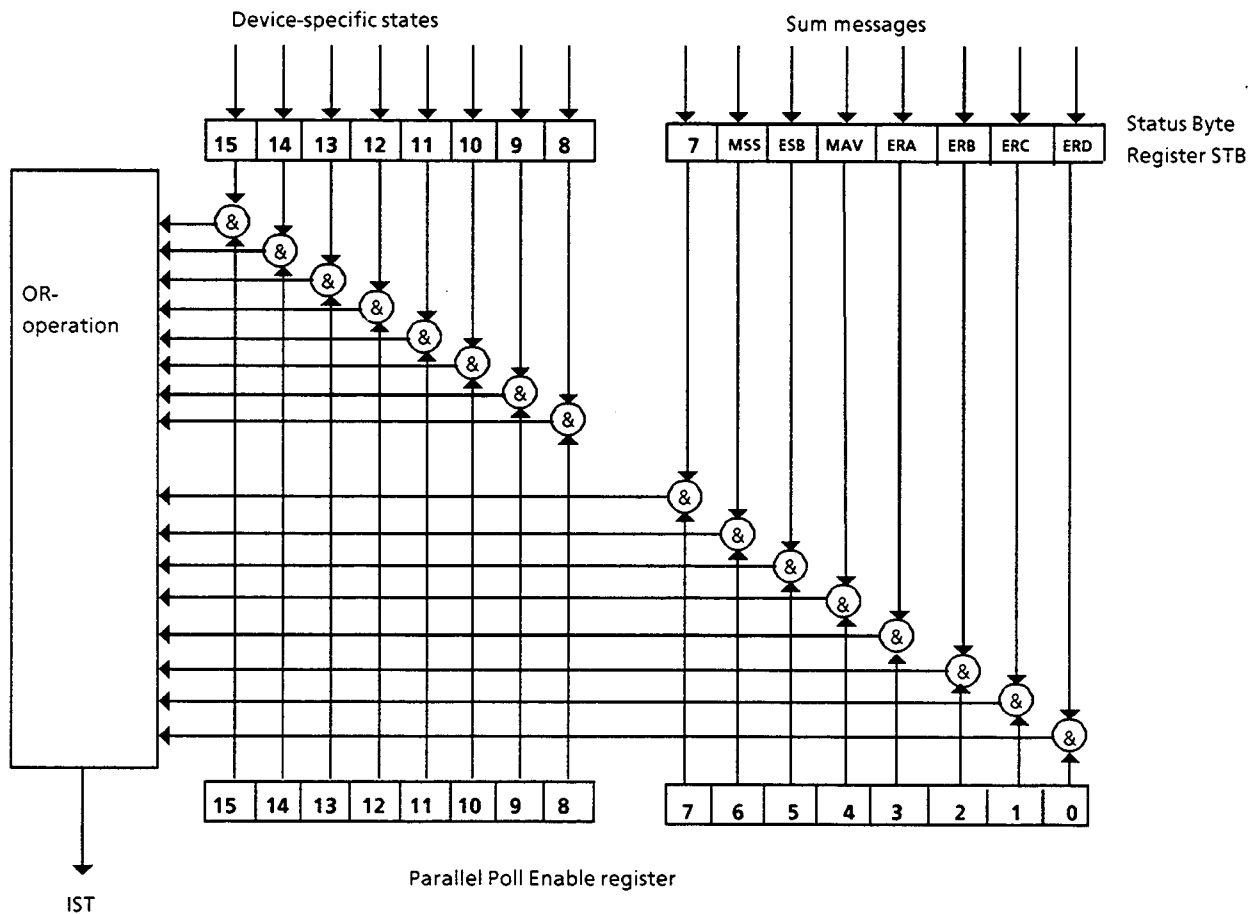

Fig. 3-36 Parallel Poll Enable Register PRE

f) Assignment and relation of the individual registers

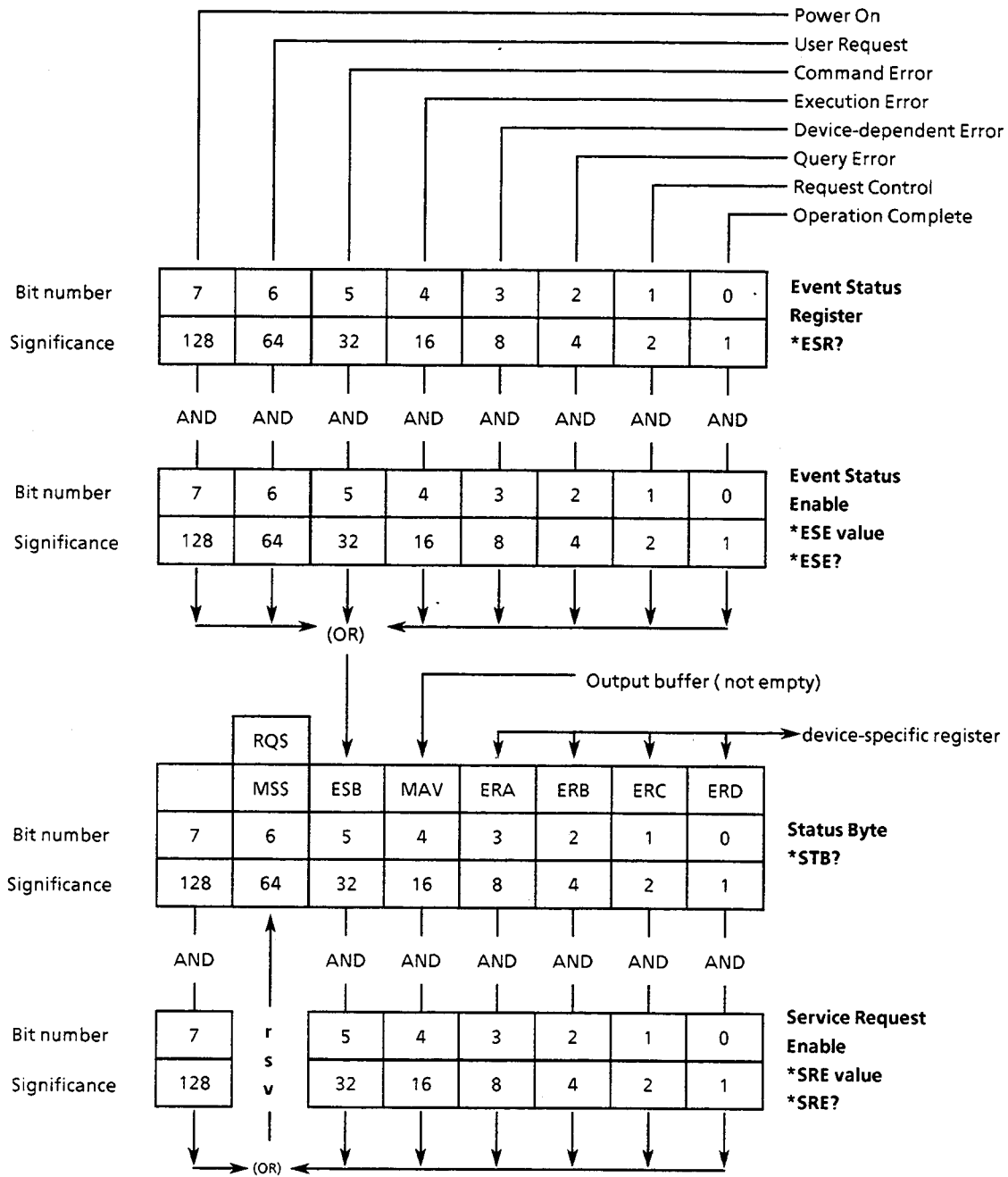

Fig. 3-37 Status register

g) Event Status Register A:

The assignment of the extended event register ERA for identifying the device status is explained by means of the following diagram :

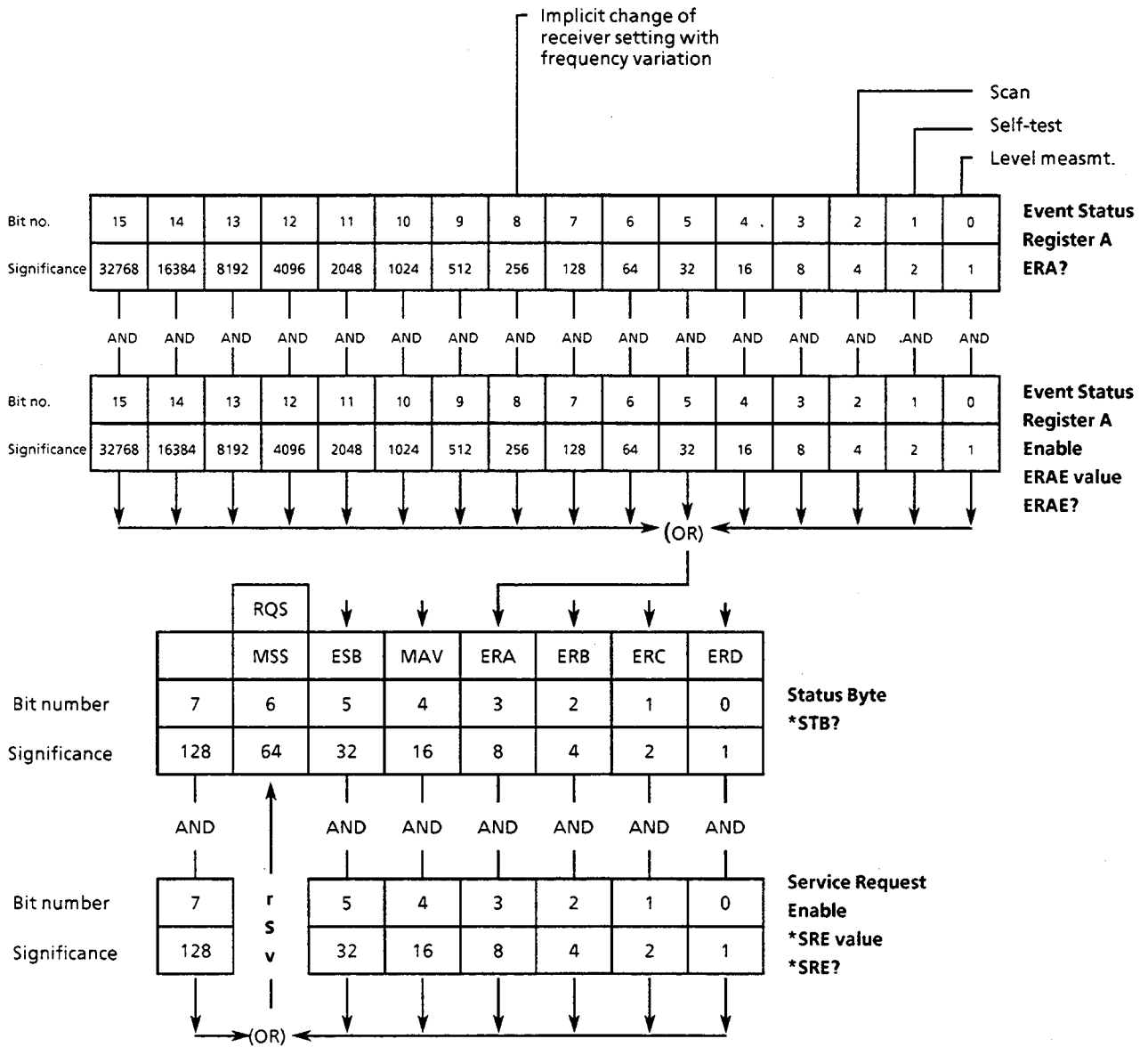

Fig. 3-37 Status register ERA

Bit 8 is set if a receiver setting other than the frequency setting has been automatically changed by a frequency variation.

The other bits indicate the active functions. They are reset after terminating these functions.

h) Event Status Register B:

The assignment of the extended event register ERB for indicating the synthesizer loop error and the switch on/off of the external reference is explained by means of the following diagram:

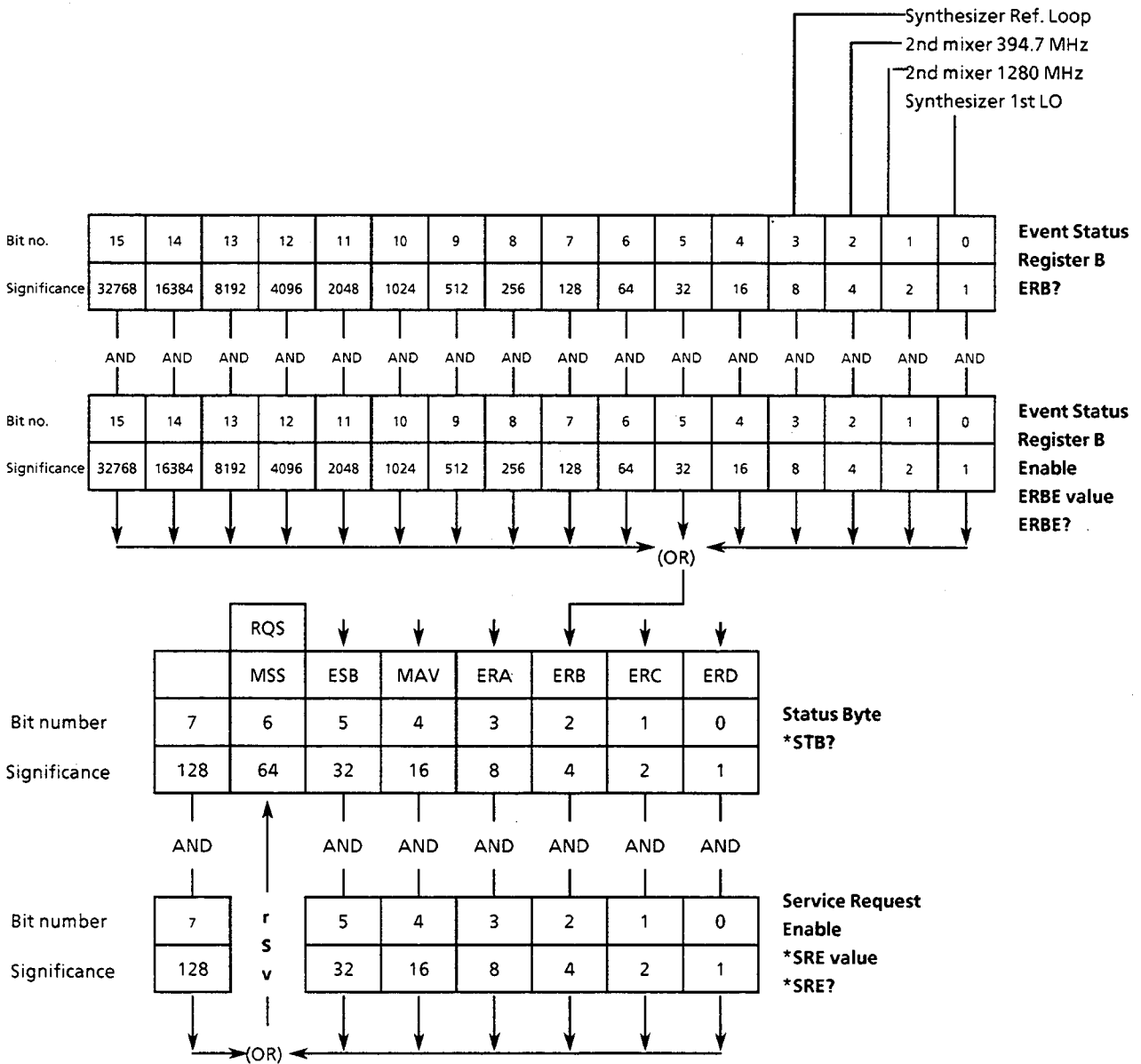

Fig. 3-38 Status register ERB

The bits are set when a synthesizer loop error occurs.

i) **Event Status Register C:**

The assignment of the extended event register ERC for indicating the validity of the measured values is explained by means of the following diagram:

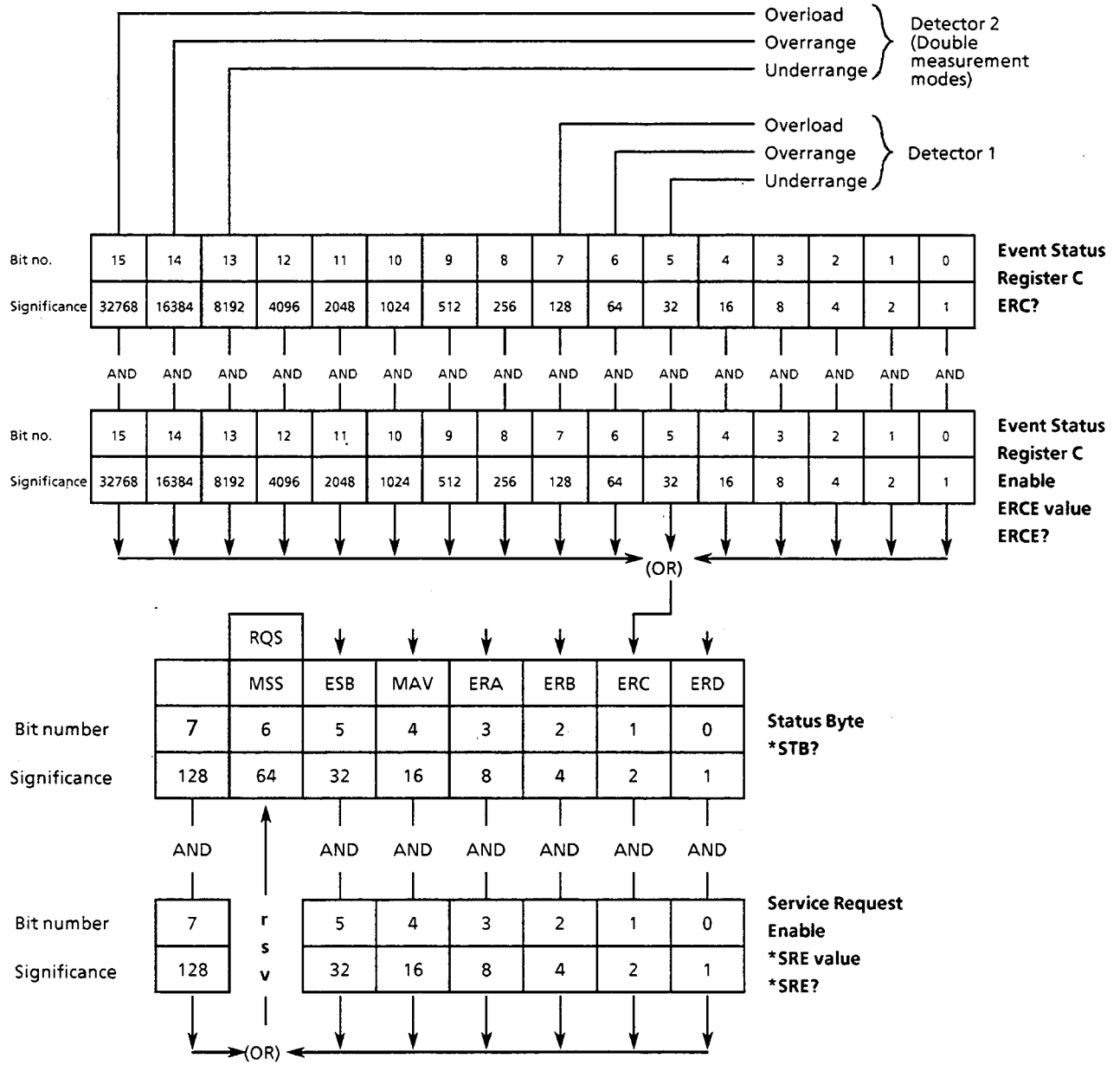

Fig. 3-39 Status register ERC

j) Event Status Register D:

The assignment of the extended event register ERD for identifying the scan status is explained by means of the following diagram:

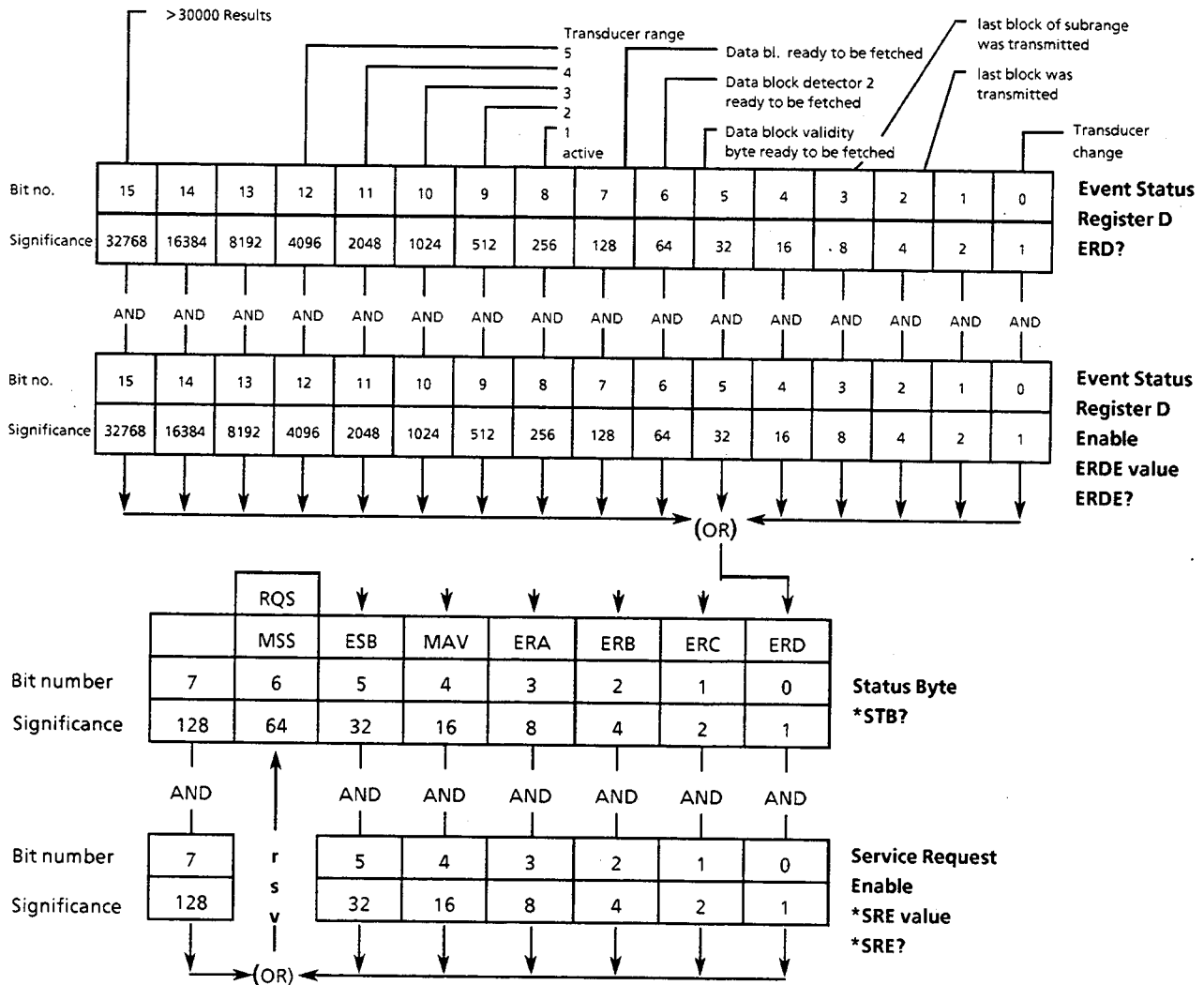

Fig. 3-40 Event Status register D

If an antenna switchover point is reached during a scan, the transducer change bit in the event status register D is set. The index of the active transducer set is identified by setting the associated bit in the register.

If the number of set measured values (SCAN:BLOCK:COUNT) is ready for output during or after a scan, the data block ready bit in the event status register D is set.

If unformatted output (SCAN:BLOCK:FORMAT DUMP or SDUMP) has been selected, bit 7 indicates the presence of level measurement values from detector 1 while bit 6 is for detector 2 and bit 5 signals that the validity byte can be fetched.

3.3.6 Resetting of Device Functions

The following table shows various commands and events that cause individual device functions to be reset:

Table 3-30 Resetting of various device functions

Event	Switching on the operating voltage		DCL, SDC (Device Clear, Selected Device Clear)	Commands		
	Power On Clear Flag			*RST	*CLS	RCL 0
	0	1				
Device default setting	--	--	--	yes	--	yes
Set ESR to zero	yes	yes	--	---	yes	---
Set ESE and SRE to zero	--	yes	--	--	--	--
Clear output buffer	yes	yes	yes	--	--	--
Clear Service Request	yes	1)	2)	--	3)	--
Reset command processing and input buffer	yes	yes	yes	--	--	--

1) Yes, but "Service Request on Power On" is possible.

2) Yes, if only conditioned by a message in the output buffer.

3) Yes, if not conditioned by a message in the output buffer.

3.3.7 Command Processing Sequence and Synchronization

The commands received by the ESPC are first stored in an input buffer which can accommodate up to 4096 characters. Once the terminator has been received, the commands are processed in the sequence in which they were sent. During this time, the IEC-bus can be used for communication with other devices. Command lines which exceed the capacity of the input buffer are processed in several sections. The bus is occupied during this time.

The commands *OPC and *OPC? (operation complete) are used as feedbacks to inform on the time at which processing of the received commands was terminated and a scan (if any) has been completely executed.

*OPC sets bit 0 in the Event Status register, and a Service Request can then be enabled if all previous commands have been executed.

*OPC? additionally provides a message in the output buffer and sets bit 4 (MAV) in the status byte.

This synchronization can be established within a command line by the command *WAI, i.e. all subsequent commands are only executed when the previous commands have been completely executed.

3.3.8 Output of Measurement Results via IEC-Bus

a) Single Measurements

The result of a single measurement is provided following a request by one of the device-specific commands LEVEL?, LEVEL:LASTVALUE? or LEVEL:CONTINUE?. The latter is especially suited for time-critical applications since the value of the last measurement can be read in immediately using an IEC bus command and the controller can subsequently process this measured value while the test receiver is already performing a new level measurement. The availability of the measurement result in the output buffer is indicated by setting the MAV bit (message available) in the Event Status register. If the associated mask register has been configured appropriately, a Service Request is thus enabled. (Program example cf. section 3.5).

The data can be output in binary or ASCII format. Selection is effected by the commands LEVEL:FORMAT BINARY or LEVEL:FORMAT ASCII. Binary output is made with 2 byte where the measured value was multiplied by 100 to obtain an integer. Resolution is 0.01 dB and the output in ASCII format is performed correspondingly e.g. with the header LEVEL 12.56.

With a double measurement mode set the measured value of the second detector is also output. In ASCII format the value is separated from the first value by a decimal point, e.g. LEVEL 12.56,7.98. In binary format two more bytes are added without using any separators.

The associated header can be switched on and off using the commands HEADER ON and HEADER OFF.

The validity of a measured value is indicated via the Extended Status register ERC. The individual bits indicate exceedings of the display range or overload of the test receiver. The low-order byte (bits 0-7) is used for detector 1, the high-order byte (bits 8-15) for detector 2 in the case of double measurement modes. If only one detector is switched on, the low-order byte is used..

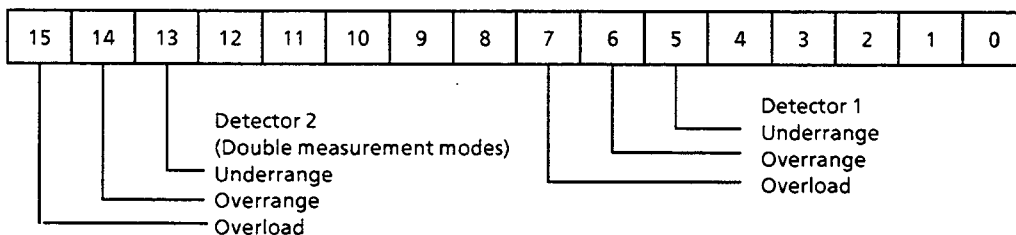

Fig. 3-41 Assignment of the Event Register ERC

The conditions overload, overrange and underrange can be used for generating a Service Request by setting a suitable bit in the associated Enable register ERCE and bit 3 in the Service Request Enable register.

b) Scan

For output of the scan results various formats are available. If complete information on each test point is desired, it is possible to output with each frequency the appertaining level values, a status word, the appertaining transducer factor, if switched on, one or two limit values at the respective frequency and a limit value byte providing information on whether the limit value(s) have been exceeded. The command "SCAN:BLOCK:ELEMENT COMBINED" serves to select this output form.

"SCAN:BLOCK:ELEMENT TRACE" serves to output only the highest level values of the 400 scan subranges. They correspond to the values contained in a test report output on printer or plotter. They are suited for graphical representation of the measurement results without loading the evaluation program and test receiver with the transmission and evaluation of unnecessary data

"SCAN:BLOCK:ELEMENT SUBRMAX" is used to select a similar format. However only the number of subrange maxima defined by the user by way of the command "SCAN:OPTION:SUBRANGES n" is output.

The block elements stated above can be further distinguished by output in binary format and in ASCII format. The commands "SCAN:BLOCK:FORMAT BINARY" and "SCAN:BLOCK:FORMAT ASCII" serve to select between the formats. Please note that in ASCII format the length of a block element may reach more than twice the size of an element in binary format and that internal data processing takes longer than with binary format.

Another form is the unformatted output described below. Three more types of block elements are available for this kind of output.

The table provides an overview on the assignment of the possible block elements to the formats:

	ASCII	BINARY	DUMP	SDUMP
COMBINED	✓	✓		
TRACE	✓	✓		
SUBRMAX	✓	✓		
DET1	✓	✓	✓	✓
DET2			✓	✓
VALID			✓	✓

To ensure that data transmission is as fast as possible and the scan is not slowed down by unnecessary IEC bus traffic, the scan measurement results are output in the form of blocks. The block size can be selected by the user using the command "SCAN:BLOCK:COUNT value" where "value" is the number of individual measurements that can be transmitted together. The output of measurement values is suppressed during a scan using SCAN:BLOCK:COUNT 0. The number of blocks is calculated automatically depending on the output buffer size after having programmed SCAN:BLOCK:COUNT MAX.

SCAN:BLOCK:COUNT SUBRANGE is used to set the number of values to be transmitted such that the "measured value ready" bits (see below) are set only when a complete subrange is ready. In case the number of data appertaining to a subrange exceed the size of the output buffer transmission must be performed in sections. Bit 3 in the extended Event Register ERD is set to indicate complete transmission of a subrange.

Formats ASCII and BINARY:

Please note that block size and format must be defined prior to the start of RF analysis.

During a scan the measurement values are stored internally until the selected block size is reached or the output buffer is filled. In this case bit 7 in the Event register ERD is set. This in turn triggers a Service Request of the receiver, if bit 7 in the Event Enable register ERDE is set. The stored results can then be requested using the command SCAN:BLOCK?. The measurement values collected are transmitted at one go.

The space a single measurement requires in the output buffer depends on the measurement mode and the use of transducer factors and limit lines. The elements of the data blocks can be polled using `SCAN:BLOCK:TEMPLATE?`. A word the respective bits of which represent the components of a block element is returned. If a bit has the value 1, the respective element is contained in the data block.

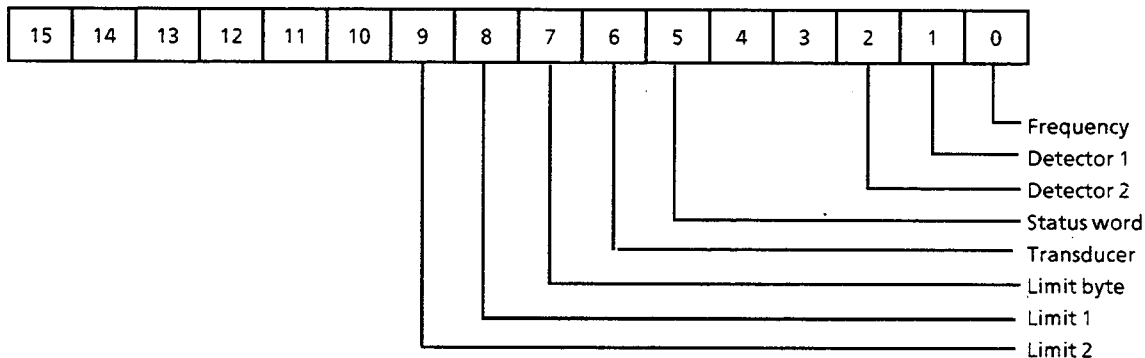

Fig. 3-42 Format of template word

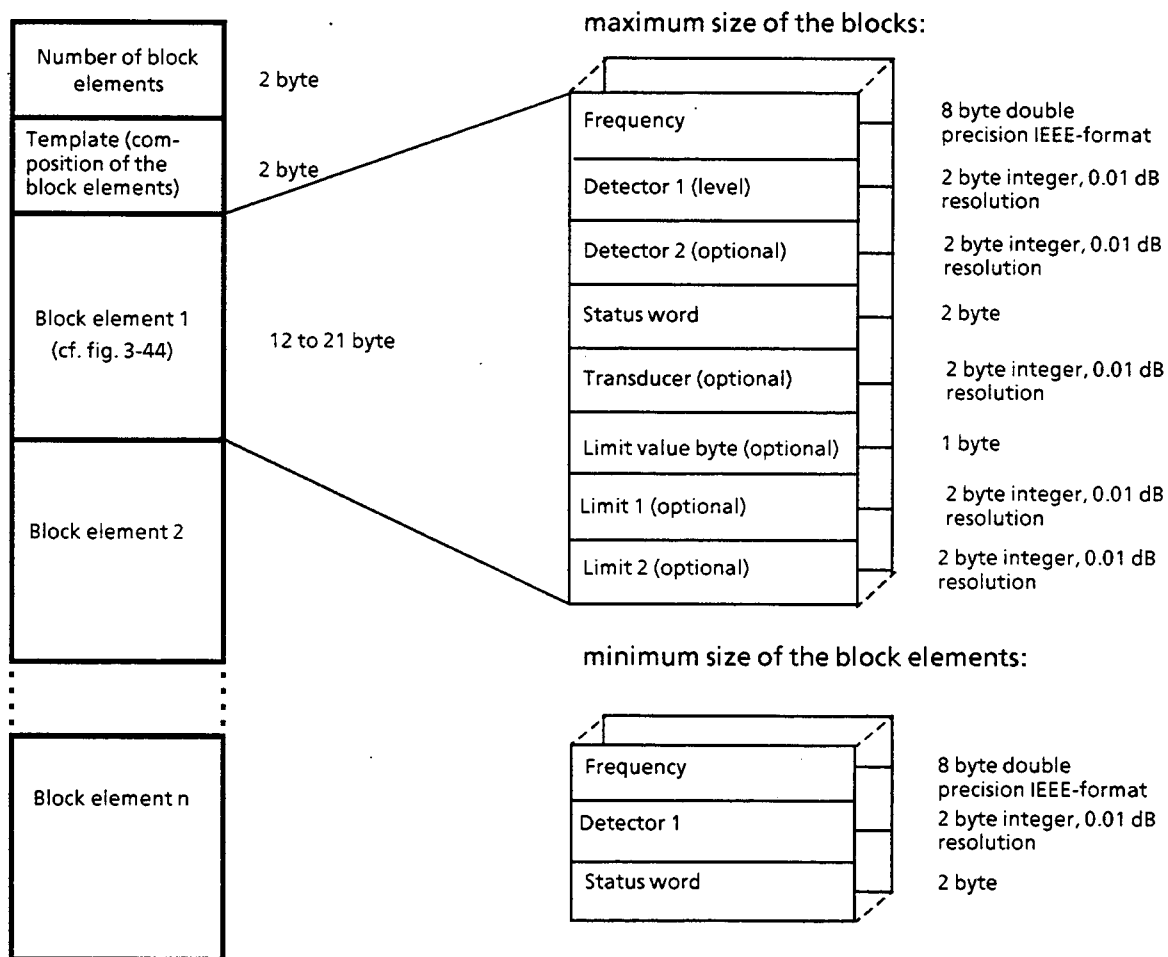

Fig. 3-43 Composition of a data block in binary format

Fig. 3-44 Examples of block elements in binary format

ASCII-format of the Block Elements:

Frequency,detector1[,detector2],status word[,transducer][,limit byte][,limit 1] [,limit 2]

The frequency is transmitted in the basic unit Hz, level (detector(s), transducer and limits) in dB with a resolution of 0.01 dB and the status word as well as the limit byte as decimal values.

The format of the status word corresponds to the extended Event register ERC.

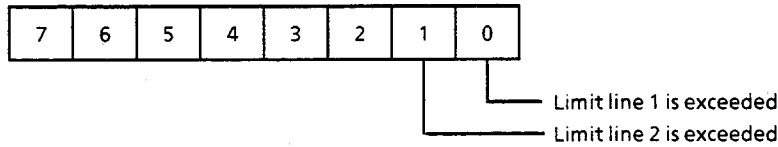
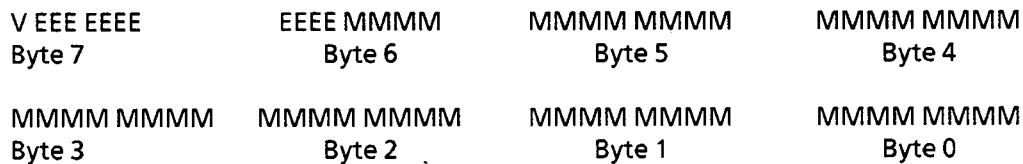

Fig. 3-45 Format of the limit byte

IEEE-number format for floating decimal point variables (Double precision for frequencies):



V = 1 bit sign, E = 11 bit exponent, M = 52 bit mantissa

The sign bit 1 means a negative number, 0 a positive number.

The exponent in the E-field is specified as a complement on two to the basic value 1024.

The mantissa is normalized, i.e. MSB is always assumed to be "1". An effective precision of 53 bit is thus achieved.

The decimal value is obtained by multiplying the mantissa by 2 ^ (E-1023). Make sure that the MSB of the mantissa is 1 at any rate, i.e. the value of the mantissa may only be higher than or equal to 1 and lower than 2.

The bytes are always arranged in increasing order.

Formats for DUMP and SDUMP

For applications requiring the data to be made ready for use as fast as possible the results of RF analysis can be output unformatted.

"SCAN:BLOCK:FORMAT DUMP" and "SCAN:BLOCK:FORMAT SDUMP" serve to select this type of output.

The data are transferred in the form they are present in the internal measured value memory of the ESPC. Each value is represented in the data block by a 2-byte integer number with a resolution of 0.01 dB in binary format. The results are arranged in increasing sequence. Since the receiver frequencies are not output, assignment of the level values to the frequencies must be performed using the start and stop frequencies and step widths of the scan data set.

With a double detector selected, the level values of the second detector are stored internally in a separate measured value memory. This applies also to the validity bytes which are contained in another memory and are arranged in increasing sequence.

Since the data can be transferred directly from the measured value memory, only one of the three types of results can be output. The command "SCAN:BLOCK:ELEMENT DET1" is used to select detector 1, "SCAN:BLOCK:ELEMENT DET2" detector 2 and "SCAN: BLOCK:ELEMENT VALID" the validity byte, respectively. It is possible to make a selection while a scan is running.

The number of measured values transferred in one block can also be defined using the command "SCAN:BLOCK:COUNT n". With the number set to the value 0, output is not performed during analysis. Please note in this case that the maximum size a block can reach is not limited by the size of the output buffer, which is 4096 bytes. The limit is however 60,000 bytes as each of the measured value memories has a capacity of 30,000 values each represented by 2 bytes.

Since the output is not performed via the output buffer the command "SCAN:BLOCK?" must not be combined with other polling commands with unformatted output being selected.

As a rule, no header is output.

Users of R&S-BASIC must observe that a string can achieve a maximum length of 32 kbytes. For this reason a maximum of approx. 16,000 values each represented by two bytes can be transferred at one time.

With a corresponding amount of measured values being ready to be fetched a message is given by bits set in the extended Event Register ERD.

Results from detector 1 are indicated by bit 7, results from detector 2 by bit 6 and the validity byte by setting bit 5, respectively. This assignment allows to use a universal program routine during the evaluation of the ERD register contents.

The mechanism of data transfer is not affected by how far RF analysis has proceeded. Even with the scan already terminated the availability of measured values not yet fetched is indicated by repeated setting of the appropriate bits in the ERD register.

Scans providing more results than the measured value memory with a storage capacity of 30,000 values can accept are exceptions. With its capacity exhausted, the measured values are stored in a temporary buffer. If the latter is also fully used, or the configured number of measured values per block is reached, RF analysis can only be continued after all results, i. e. from detector 1, or, as the case may be, from detector 2 and the validity byte have been read out.

With format DUMP, bit 2 is set in the ERD register (last block has been transmitted) either after all measured values from detector 1 *or* from detector 2 *or* all validity bytes have been transferred.

With format SDUMP (Synchronized DUMP), bit 2 is set only after all measured values *and* all validity bytes have been read out.

The status word which is assigned in the same way as in the Event register ERC is saved internally in a byte. With unformatted output, the internal format is output, which is different from the status word in the block formats ASCII and BINARY.

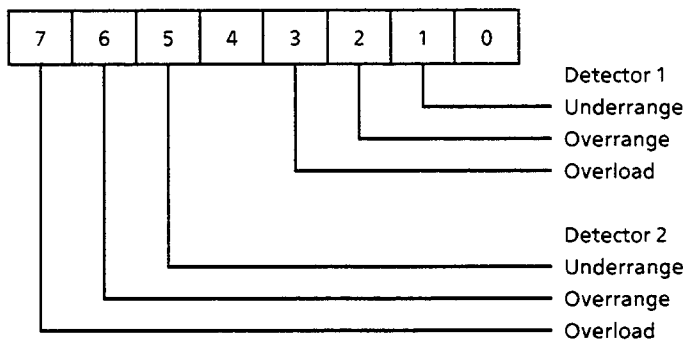

Fig. 3-46 Format of the validity byte with unformatted output of scan results.

The scan results can be queried as often as desired even after termination of scans carried out in LOCAL or REMOTE mode. There are two ways to query the results:

- 1) Execution of command SCAN:BLOCK?. The presence of measured values causes a data block to be made available and the bits in the ERD register to be set.
- 2) Execution of command SCAN:RESULTS. Only the bits in the ERD register are set, which has the advantage that afterwards the same mechanism as in a parallel transmission can be applied. Using this command, transmission always starts with the first value in the measured value memory.

3.3.9 Transfer of the IEC-Bus Controller Function

The ESPC must be able to activate the control line ATN (Attention) so that it is possible to send commands to other IEC-bus devices. Only the active IEC-bus controller (Controller in Charge) is entitled to do so. The ESPC needs to be Controller in Charge in order to program IEC-bus controlled plotters and thus output test reports.

The test receiver can obtain the controller function in the following ways:

1. There is no process controller connected to the IEC-bus.

This is recognized by the ATN-line and is usually the case when the ESPC operates in the Stand-Alone mode.

The ESPC can then configure itself as IEC-bus controller and end the controller function following completed plotter output (Release Control).

2. A process controller is IEC-bus controller.

This is always true, when the ESPC is controlled by a controller connected to the IEC-bus.

In this case IEC-bus control is transferred to the test receiver via talker addressing and passed back to the controller after plotter output has been terminated ("Pass Control Back").

3.3.10 Error Handling

Errors that are detected in connection with IEC-bus operation are indicated by setting a bit in the Event Status register. These are bit 2 for a query error, bit 4 for an execution error and bit 5 for command error. Device-specific errors are signaled by setting bit 3 (device-dependent error).

These bits remain set until the Event Status register is read out or cleared by the commands *RST or *CLS. A Service Request can thus be enabled and the type of error can be evaluated by way of program control.

A more detailed error message can be obtained by way of the command SYSTEM:ERROR?. A decimal value is output, which can be interpreted in accordance with table 3-31.

Table 3-31 Error messages

0	no error
-100	internal error
-101	syntax not correct
-102	wrong data type
-113	unknown command or command not clear
-130	wrong or unclear unit
-141	wrong or unclear character data
-161	illegal block data
-221	input not allowed
-222	date is out of the permissible range, if not already specified by error message >0
-400	overflow of output buffer
-410	output data were not read and overwritten
-420	no output data available during the attempt to read them
3	setting not allowed in this connection
4	date is out of permissible range
9	unit not correct
16	minimum frequency exceeded (e.g. transducer factors)
17	maximum frequency exceeded
18	minimum level exceeded
19	maximum level exceeded
20	wrong order of frequency values
100	no scan defined during the attempt to program scan data

3.4 Applications

The *options* of the RF-analysis serve to specify the measurement sequences that are optimal for the different applications of the ESPC. The options are divided into groups and some of them can be combined with each other.

The semi-automatic measurement sequences described below can be applied when the interference is stable within the measuring time. Manual measurement is recommended to be used for intermittent, quickly drifting and cyclic interferences with long cycle times.

The most important criteria of automatic measurement are

- time-efficiency
- high reliability and accuracy
- reproducibility of results
- automatic and complete display of results

RFI measurements sometimes are very time-consuming due to the time-constants specified by the standard for quasi-peak weighting which cause settling procedures requiring long measuring times for each measured value. The standards furthermore prescribe search procedures to determine the interference radiation maxima such as shifting the absorbing clamp, varying the height of the measuring antenna or turning the device under test in another direction. Thus, performing measurements including quasi-peak weighting for each frequency and each setting of the measurement configuration would lead to unacceptably long measuring times. Therefore, R&S developed a system reducing the time-consuming measurement procedures to a minimum while providing high reliability concerning the acquisition of measured values.

The interference spectrum is first analyzed to optimize the measurement sequence as to time. **Data reduction** is subsequently performed so that a **final measurement** must be carried out at few frequencies only.

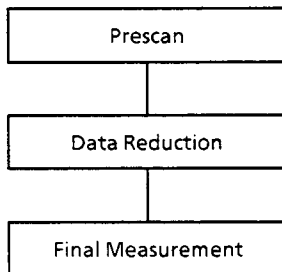

The data reduction is of decisive importance. Option 30 is used for this purpose (subrange maxima and acceptance analysis):

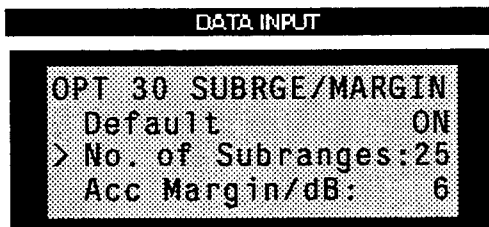

Frequencies with especially high interference levels can be determined already during prescan with the help of option 30. It implies two methods for data reduction:

- Determination of subrange maxima, i.e. the interference spectrum is only further examined at those frequencies with the highest interference levels within one frequency subrange. The entire frequency range is divided up into up to 400 subranges. A subrange maximum is determined for each subrange during the prescan.
- Acceptance analysis, i.e., the interference spectrum is only further examined at those frequencies with levels exceeding a line which is parallel to the limit value line. Thus, measuring frequencies with the noise levels being far below the limit value is no longer necessary. The safety margin between the assumed acceptance line and the limit line is freely definable by the user as Acceptance Margin.

Two values have therefore to be specified:

- the number of *subranges* (a value out of 8, 16, 25, 50, 100, 200, 400; default value: 25)
- the *acceptance margin* (Acc. Margin/dB; default value: 6 dB). This applies to each of two limit lines.

A menu for selecting and entering these values is displayed when calling the option 30. Upon pressing the → key, the cursor is located at the line >Default..., if the default values have not yet been set, otherwise the cursor is set to the number of *subranges*. If *Default* is set to *OFF*, the default values can be activated by pressing the ENTER key. The cursor can be moved to the desired line using the ↑ ↓ keys. The values for *No of Subrges* and *ACC Margin/dB* can be set using the numeric keys and are accepted by way of ENTER. Both, switching on the option and changing the values can also be performed after the prescan has been executed, since 400 subrange maxima are always stored.

Options 40 to 45 serve to specify the detectors for the final measurement at the frequencies determined during the data reduction. If none of the options 40 to 45 is switched on, a final measurement is not performed.

Option 62 defines that the interference spectrum is output via the plotter simultaneously with the measurement.

When the option 63 (Special Scan) is selected, entering <RUN> does not lead to a scan according to the RF-analysis data set but only to scanning the frequencies of a frequency list entered by means of this option or the frequencies of a list resulting from the data reduction.

Calling the options (cf. section 3.2.4.3.3):

- ▶ Press the OPTIONS key.
The options are listed on the DATA INPUT display:

```
DATA INPUT
Scan Options
>01 RFI Voltage OFF
>04 RFI Power OFF
06 RFI Field Str OFF
-----
26 Gated Scan OFF
30 Subrge/Margin ON
40 Final AV OFF
42 Final QP OFF
45 Final QP/AV OFF
62 Meas.+ Plot OFF
63 Special Scan OFF
```

visible when calling
via the OPTIONS key

can be scrolled using the
↑ ↓ keys

The options 01, 04 and 06 are used for defining the measuring configurations for the different applications of the EMI Test Receiver ESPC:

- Option 01 for RFI voltage measurement using the artificial mains network
- Option 04 for RFI power measurement using the absorbing clamp and
- Option 06 for RFI fieldstrength measurement.

RFI voltage and RFI current measurements can be performed in the range from 30 MHz without using any specific option.

3.4.1 Measuring the RFI Voltage in the Frequency Range up to 30 MHz

RFI voltage measurements up to 30 MHz are carried out either using artificial mains networks or probes with an impedance of 1.5 k Ω or ≥ 100 k Ω .

The following R&S-accessories are used for RFI voltage measurements

- Active Probe, $Z_{in} \geq 100$ k Ω ESH2-Z2
- Passive Probe, $Z_{in} = 1.5$ k Ω ESH2-Z3
- Artificial Mains Network (four-wire system) ESH2-Z5
- T-network ESH3-Z4
- Two-line V-network ESH3-Z5
- V-network 5 μ H//50 Ω ESH3-Z6
- 4-wire-T-network EZ -10

The probes and V-networks serve to test the unsymmetrical RFI voltage whereas the T-networks are suitable for asymmetrical ones. The frequency range of RFI voltage measurements is generally limited to the range 9 kHz to 30 MHz in national and international standards. RFI voltage measurements on automotive accessories involve frequencies of up to 108 MHz.

Detailed information on which artificial mains networks are to be used in which cases is given in the latest versions of the standards - CISPR Standards, European Standards, VDE-Regulations, FCC Rules & Regulations, etc.

a) Test Setup

To avoid measurement errors caused by ambient interference the device under test and measuring sensor (artificial mains network or probe) should be operated inside the shielded room, whereas the test receiver together with printer and plotter should be set up outside the room.

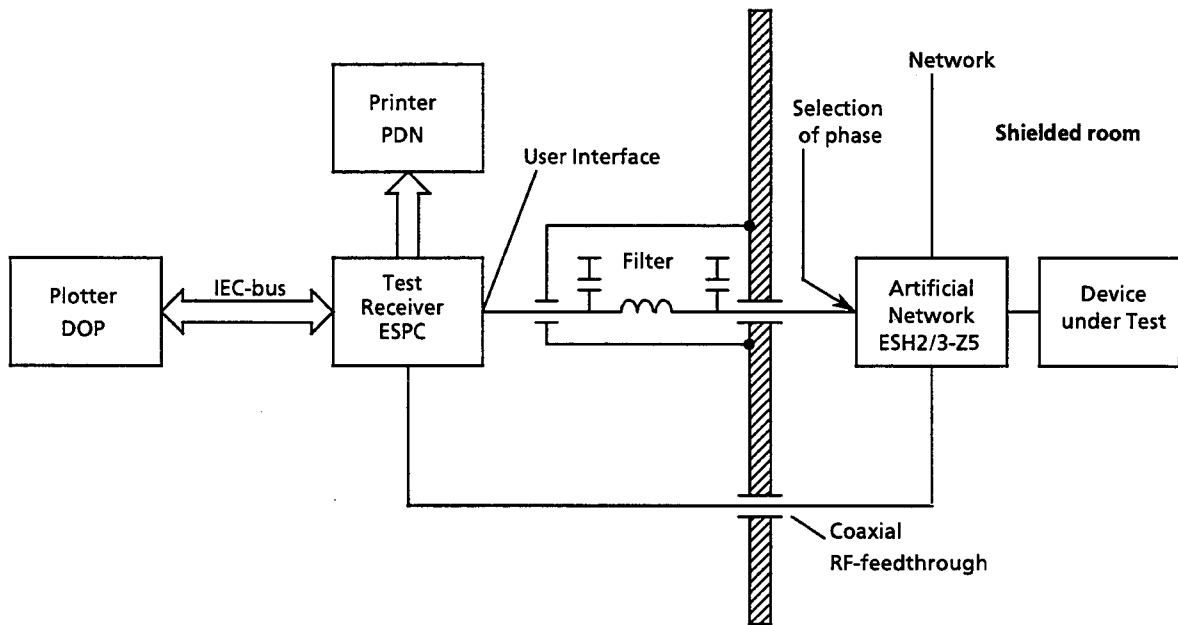

Fig. 3-47 Block diagram of a test setup with artificial mains network and device under test in a shielded room

The Test Receiver ESPC itself can be set up inside the shielded room due to its low radiation. Simultaneous operation of printer and plotter inside the room may however cause problems if the setup is unfavourable. In this case the output of the test report should be performed upon the measurement.

The following connections between ESPC user interface and artificial mains network serve for automatic phase selection when using the artificial mains networks ESH2-Z5 and ESH3-Z5:

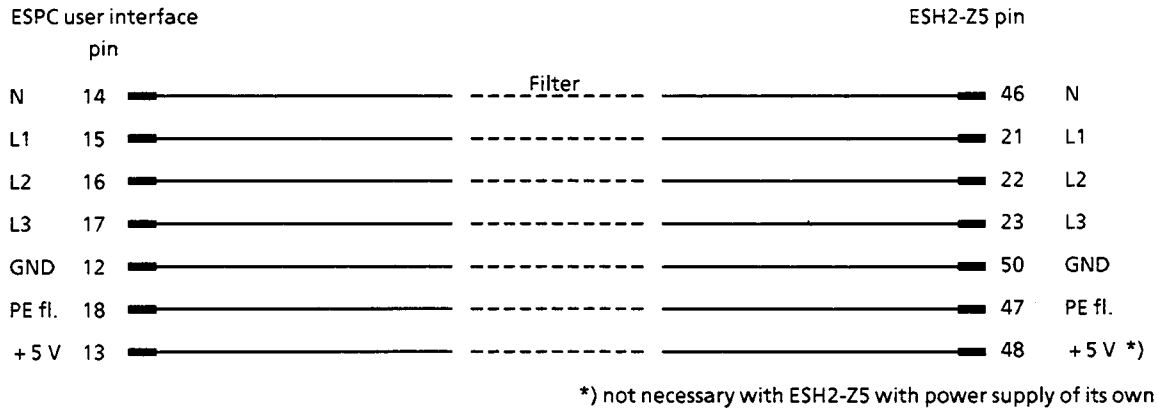

Fig. 3-48 Connection between ESPC and ESH2-Z5 (cable EZ-13)

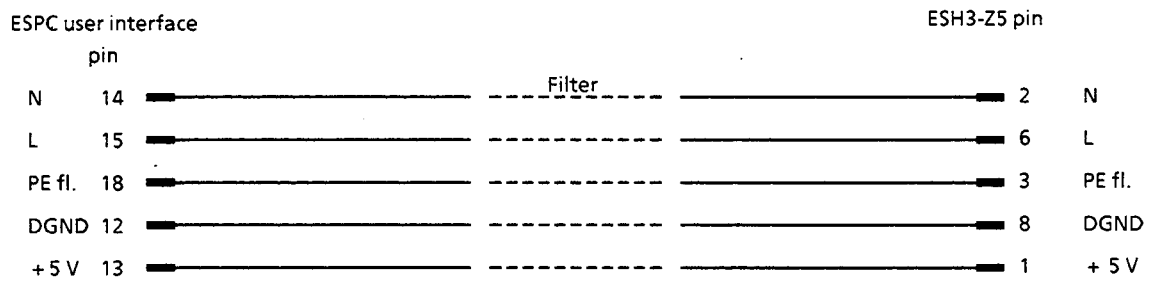

Fig. 3-49 Connection between ESPC and ESH3-Z5 (cable EZ-14)

The supply voltage + 5 V and some of the control lines must be fed through the wall of the shielded room for control of the phase selection and PE simulating network of the Artificial Mains Networks ESH2-Z5 and ESH3-Z5.

The connecting cables EZ-14 and EZ-5 can be supplied for the Four-line Network ESH2-Z5 and the cables EZ-14 and EZ-6 are designed for the Two-line Network ESH3-Z5.

Proposed arrangement of the connecting cables EZ-14 | EZ-5 | EZ-6

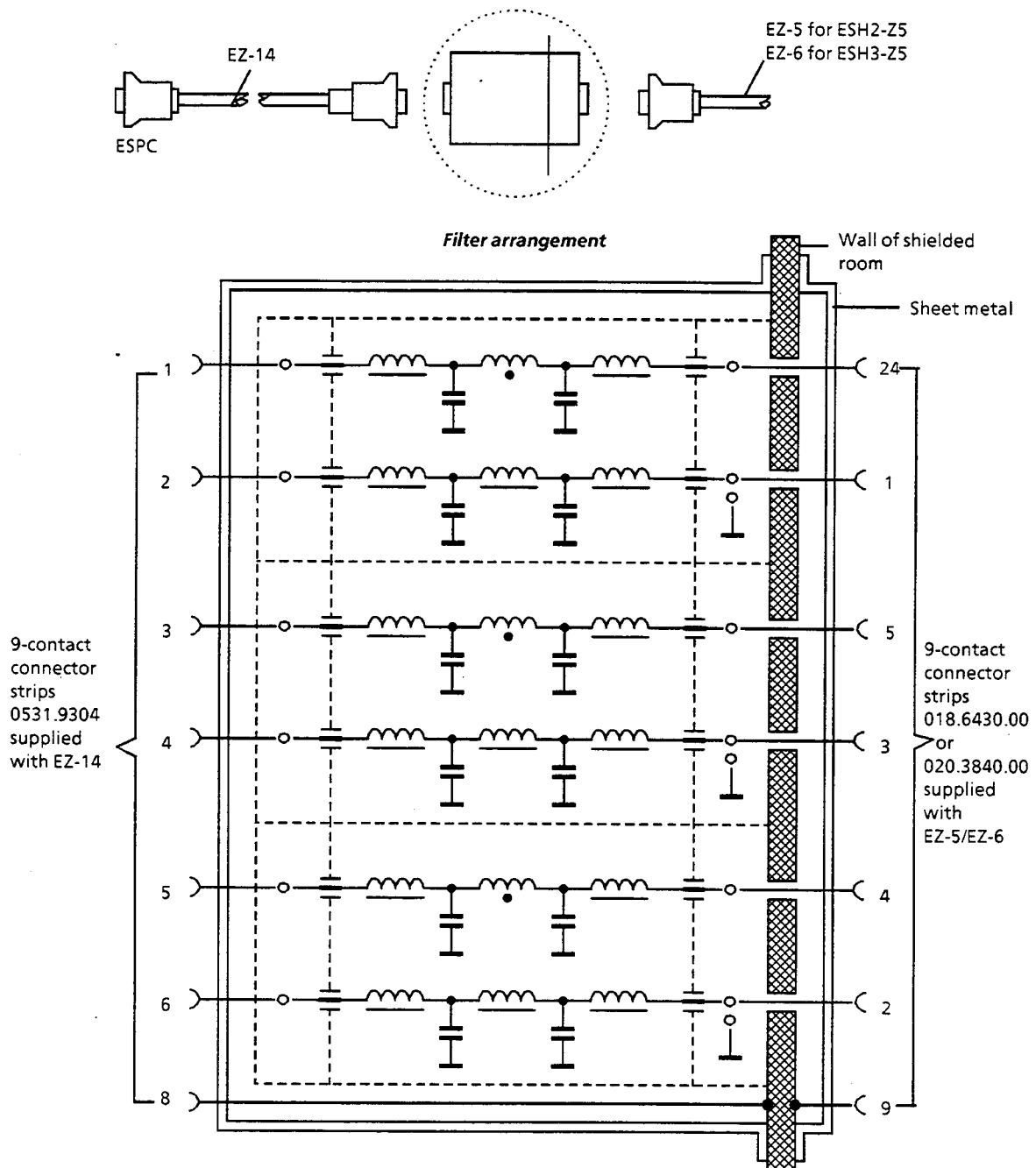

Fig. 3-50 Arrangement of the connecting cables EZ-5, -6 and -14 with AF-filters to provide the 5-V supply and control information for the Artificial Mains Networks ESH2-Z5 and ESH3-Z5 in a shielded room.

Note: If the ESPC is operated inside the shielded room, the filter arrangement will be rendered unnecessary. The cable EZ-14 serves to control the ESH3-Z5, the cable EZ-13 is used to control the ESH2-Z5.

Recommended low-pass filters used for the feedthroughs into the shielded room:
Siemens order no.: B 84311-C30-B3 contains low-pass filters for 2 lines. 3 units are therefore necessary for the ESH2-Z5, 2 units for the ESH3-Z5.

The setup of the device under test in the shielded room is specified in the standards relevant to the subject, e.g. VDE 0877 part 1.

b) Setting of the Test Receiver

The scan setting of the test receiver determines the data of the prescan. For RFI voltage measurements it usually comprises a range of 0.15 to 30 MHz or two ranges from 0.009 or 0.01 to 0.15 and 0.15 to 30 MHz; for measurements according to FCC Part 15 the range is from 0.45 to 30 MHz.

Further data:

Frequency range/MHz	.009 - .15	.15 - 30
Stepsize/kHz	.1	5 ¹⁾
Bandwidth (IF BW)/kHz	.2	10
Detector	Pk + Av	Pk + Av ²⁾
Meas. Time/s	.05	.02 ³⁾
Attenuation	Auto Low Noise	Auto Low Noise
Operating range/dB	60	60

- 1) With pure broadband interference, frequency-proportional step size (LOG step) can be used instead of steps half the bandwidth
- 2) For measurements according to standards with narrowband and broadband interference limit values or average and quasipeak limit values, the special function 30 with which it is possible to measure simultaneously peak and average value during one scan is useful. If there is only one limit value, it is sufficient to switch on one detector, e.g. Pk or Av.
- 3) The measuring time per measured value is determined by the type of interference signal. It must be selected such that the highest value is recorded in the case of fluctuations during time. Minimum measuring times of 20 or 10 ms are therefore required for network-synchronous pulse interferences (50 Hz or 100 Hz, 60 or 120 Hz).

The scan option 01 serves for RFI-voltage measurements. It is used to specify the following features:

- Type of artificial mains network (LISN).
If none of the artificial mains networks ESH2-Z5 or ESH3-Z5 is defined, it is assumed that the measurement is performed using a probe or a single-phase artificial mains network. As some standards also demand RFI current measurements, it can be measured instead of the RFI voltage using an RF current probe, when the transducer factor has been entered in the unit dB μ A (cf. section 3.4.2). Specification of the artificial mains networks in option 01 is no longer necessary.
- Details relating to the sequence (phase on which the pre-analysis is carried out; phases on which the final measurement is to be performed)

Operation

- ▶ Press the **OPTIONS** key.
The menu *SCAN OPTIONS* is called.
- ▶ Press one of the **ENTER** keys.
OPT 01 RFI VOLTAGE switches from *OFF* to *ON*.
- ▶ Press the **→** key.
The first menu is called:

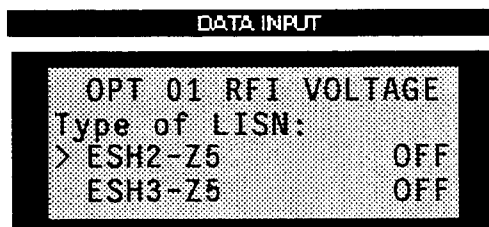

- ▶ Specify the type of artificial mains network (LISN).
If both artificial mains networks are *OFF*, the RFI voltage measurement is carried out only on one line. It must be specified, if the test is performed using a probe or a single-phase LISN (ESH3-Z4, ESH3-Z6) or an RF-current probe. One LISN maximally can be selected. If another one is switched *ON*, the first one becomes automatically *OFF*. Only when one of the two LISNs is selected, the next menu appears.

- ▶ Press one of the ENTER keys to select the LISN
 - ▶ Press the → key.
The next menu is called, the test configuration for the prescan is specified as follows:
- * Using the ESH3-Z5:

```

DATA INPUT
OPT 01 PRESCAN/MANUA
> Phase L1      ON
  Phase N      OFF
  PE grounded   ON

```

Only one phase can be switched on. If *PE grounded* is *OFF*, the PE simulating network is switched on.

- * Using the ESH2-Z5:

```

DATA INPUT
OPT 01 PRESCAN/MANUA
> Phase L1      ON
  Phase L2      OFF
  Phase L3      OFF
  Phase N      OFF
  PE grounded   ON

```

Only one phase can be switched on. If *PE grounded* is *OFF*, the PE choke is switched on.

- ▶ Press the → key.
The next menu is called, the test configuration for the prescan is specified as follows:

- * Using the ESH3-Z5:

```

DATA INPUT
OPT 01 FINAL MEAS
> Phase L1      ON
  Phase N      ON
  PE grounded   OFF
  PE floating   ON

```

In this example it is measured on both phases. If both *PE grounded* and *PE floating* are set to *ON*, four measurements are carried out on each frequency determined by data reduction to find out the configuration with the highest RFI voltage. In line with a resolution by the CISPR/G it is measured on both phases only using a PE simulating network , i.e. *PE grounded OFF* and "*PE floating ON*."

* Using the ESH2-Z5:

DATA INPUT	
OPT 01 FINAL MEAS	
> Phase L1	ON
Phase L2	OFF
Phase L3	OFF
Phase N	ON
PE grounded	ON
PE floating	ON

As already described with the ESH3-Z5, four measurements are carried out at each frequency in this case.

c) Measurement Sequence, Measurement and Analysis Procedure

The prescan is started by activating the RUN/STOP key. It can further be interrupted by pressing this key once and aborted by pressing the key twice (for more details cf. section 3.2.4.3.4).

At the end of each subrange the phase with the highest RFI voltage is determined and the QP-measurement is started, if one of the following options is selected (measuring time for the final measurement can be set separately in each case, cf. section 3.2.4.3.2):

Option 40 Av Meas. = ON: Comparison of the Av-values of the RFI-voltages on all phases provided in the menu *Final Measmt* with the possible PE-configuration(s) and determination of the phase with the highest Av-level at the frequency of the subrange maximum. (The option 40 requires the Av-detector during prescan; it is therefore automatically set with this option).

Option 42 QP Meas. = ON: Comparison of the QP values of the RFI voltages on all phases provided in the menu *Final Measmt* with the possible PE-configuration(s) and determination of the phase with the highest QP level at the frequency of the subrange maximum. (The option 42 requires the Pk detector during prescan; it is therefore automatically set with this option).

Option 45 QP/Av Meas. = ON: With the Pk maximum of the subrange:

Comparison of the QP values of the RFI voltages on all phases provided in the menu *Final Measmt* with the possible PE-configuration(s) and determination of the phase with the highest QP level.

With the Av-maximum of the subrange:

Comparison of the Av-values of the RFI-voltage on all phases with the possible PE-configuration(s) and determination of the phase with the highest Av-level. (The option 45 requires the SF 30 (Pk and Av) during prescan; it is therefore automatically set with this option.)

Option 62 Meas + Plot = ON: Plotting of the interference spectrum during the measurement. When starting the scan, everything defined under *Report Setting* in the menu is plotted. If *Curve* in this menu is switched off, the warning *Warning Curve OFF* appears.

3.4.2 Measuring the RFI Current in the Frequency Range up to 30 MHz

a) Test setup

To avoid measurement errors as a result of ambient interference, the device under test and RF-current probe should be operated in a shielded room whereas the test receiver with printer and plotter should be set up outside the room.

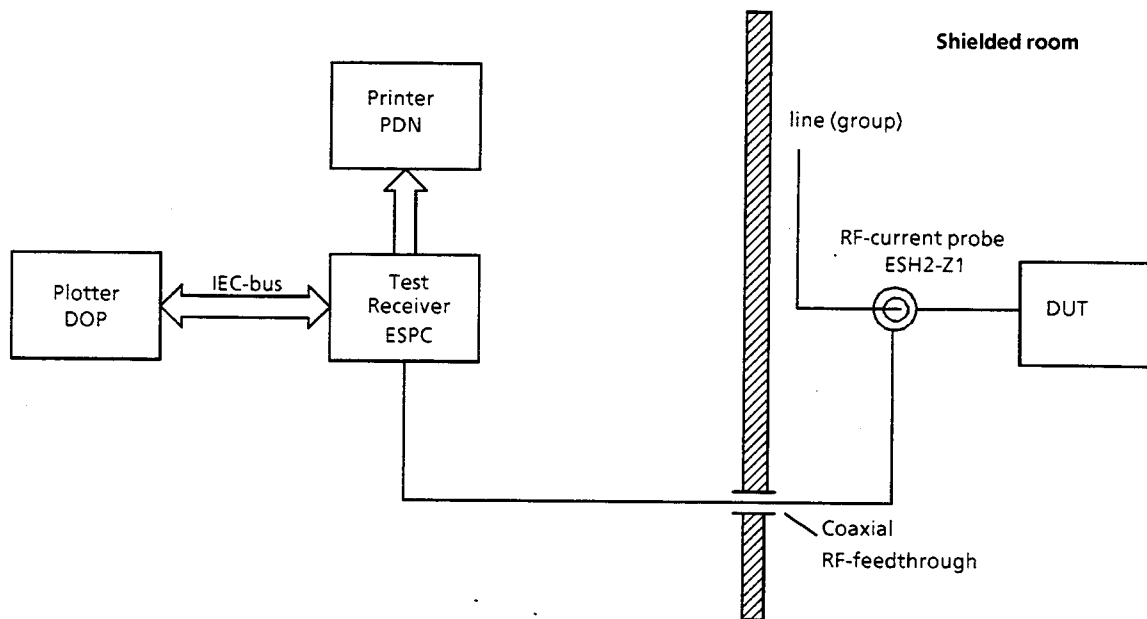

Fig. 3-51 Block diagram of a test setup with RF-current probe (ESH2-Z1) and device under test in a shielded chamber

b) Setting of the Test Receiver

The **measurement configuration** is specified by the option 01. If, as described in section 3.4.1., there is no artificial mains network selected, preparations can be made for RF-current measurements by selecting the transducer with the unit dB μ A.

The scan setting specifies the run of the **prescan** (recommended setting data, section 3.4.1.).

The **data reduction** is defined by the option 30.

For the **final measurement** the options 40 to 45 are of significance.

The option 62 specifies whether the interference spectrum is to be plotted during or only after the measurement.

c) Measurement Sequence, Measurement and Analysis Procedure

The explanations given in section 3.4.1.3 are also true in this case. There is, of course, no comparison between the RFI currents on the different phases.

3.4.3 Measuring the RFI Voltage or the RFI Current in the Frequency Range above 30 MHz

According to commercial standards RFI voltage measurements are usually performed in the frequency range above 30 MHz using either artificial networks for this frequency range or directly at the car antenna according to VDE 0879 Part 2 (draft). Probes such as the R&S probes ESH2-Z2 and ESH2-Z3 are generally not used above 30 MHz.

The R&S accessories listed below can be used for RFI voltage measurements above 30 MHz:

- T-network ESH3-Z4
- 4-wire-T-network EZ-10
- V-network 51JH//50 Ω ESH2-Z6

The V-networks are used to test V-terminal voltages whereas the T-networks are suitable for asymmetrical ones. RFI voltage measurements are generally carried out at frequencies within the range from 9 to 30 MHz according to national and international standards. The frequency range for RFI voltage measurements at car accessories, however, extends from 150 kHz to 108 MHz. The ESPC is thus only suitable for these measurements to a limited extent.

For detailed information on which artificial mains networks to be used or on the required test setups refer to the latest versions of the standards - CISPR Publications, European Standards, VDE Regulations, FCC Rules & Regulations, VCCI Recommendations, etc.

Though not prescribed by the commercial standards, RFI current measurements using RF current probes such as the ESV-Z1 or EZ-17, are very common when determining interference sources and testing devices for interference suppression.

a) Test Setup

To avoid measurement errors caused by ambient interference the device under test and the measuring sensor (artificial mains network) should be operated inside a shielded room, whereas the test receiver together with printer and plotter should be set up outside.

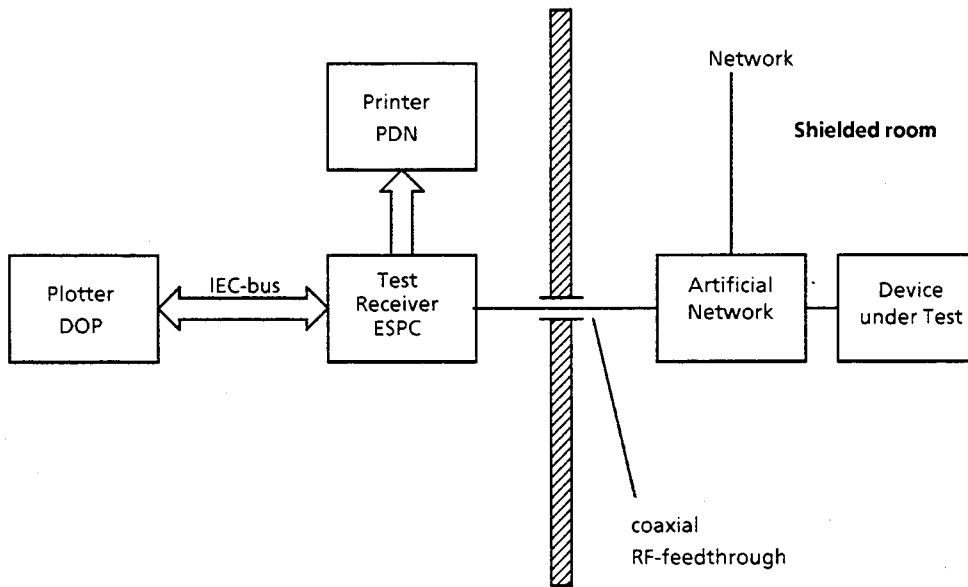

Fig. 3-52 Block diagram of a test setup with artificial network and device under test in a shielded room

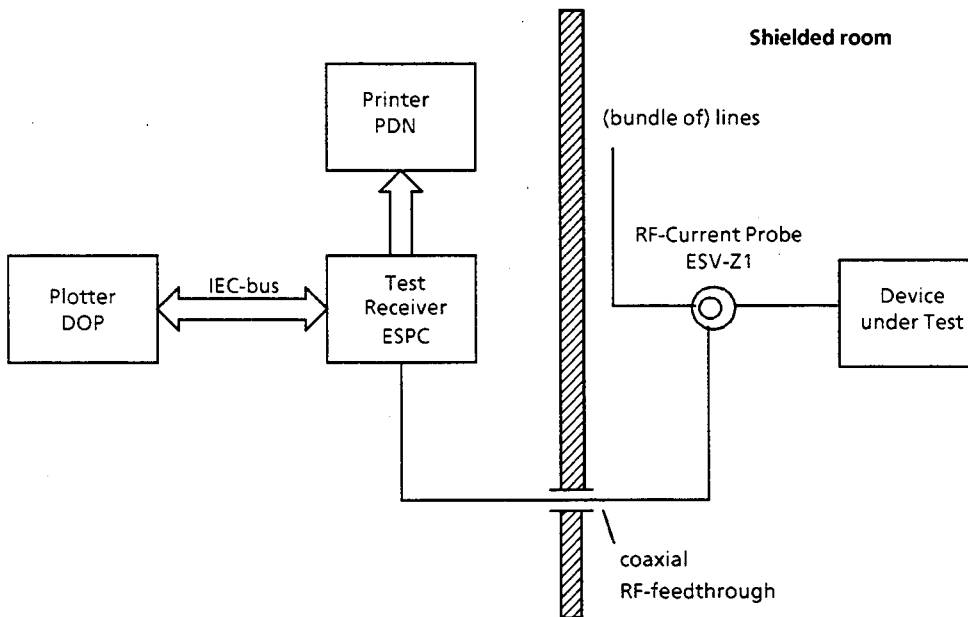

Fig. 3-53 Block diagram of a test setup with RF current probe and device under test in a shielded room

Due to its low interference radiation the test receiver ESPC can be set up inside the shielded room. Simultaneous operation of printer and plotter inside this room may, however, cause problems, if the setup is unfavourable. In this case the test report should be output subsequent to the measurement.

b) Setting of the Test Receiver

The scan setting of the test receiver determines the data of the prescan. For RFI voltage measurements at car accessories, e.g., it covers a range from 0.15 to 108 MHz. The remaining measuring range for the ESPC is then 30 to 108 MHz.

Scan data:

Frequency range/MHz	0,15 - 108
Stepsize/kHz	60 1)
Bandwidth (IF BW)/kHz	120
Detector	PK + AV 2)
Meas. Time/s	.02 3)
Attenuation	Auto Low Noise
Operating Range/dB	60

- 1) With pure broadband interference, frequency-proportional step size (LOG step) can be used instead of steps half the bandwidth.
- 2) For measurements according to standards with narrowband and broadband interference limit values or average and quasipeak limit values, the special function 30 allowing for simultaneous measurement of peak and average value during one scan is useful. If there is only one limit value, it is sufficient to switch on one detector only, e.g. Pk or Av.
- 3) The measuring time per measured value is determined by the type of interference signal. It should be selected such that the highest value is recorded in the case of time-dependent variations. Minimum measuring times of 20 or 10 ms are therefore required for network-synchronous pulse interferences (50 Hz or 100 Hz).

The subsequent scan options are suitable for RFI voltage and current measurements:

There is no special option for RFI voltage or current measurements in the range of > 30 MHz. A final measurement is immediately performed at the end of each subrange, if the options 30, 40 to 45 are selected.

Phase selection as is possible with the artificial mains networks ESH2-Z5 and ESH3-Z5 below 30 MHz is not offered.

The conversion factor of the current probe or the insertion loss of the artificial mains network are to be entered via the transducer factor.

- 30 Subrge/Margin is determined as explained in the introduction to section 3.4.
Suitable settings:
No of Subranges 16 or 25
Acc. Margin/dB 10
- 40 The options 40 to 45 determine the type of detector for final measurement.

c) Test Run, Measurement and Analysis Procedure

- ▶ The prescan is initiated by pressing the RUN/STOP key. It can be interrupted by pressing this key once and aborted by pressing the key twice (cf. section 3.2.4.3.4).

At the end of each subrange a final measurement is performed, if one of the options 40 to 45 is selected.

Option 40 Final AV = ON: Final measurement of the RFI voltage (RFI current) within the measuring time defined by option 40, the average detector being at the frequency of the subrange maximum.

Option 42 Final QP = ON: Final measurement of the RFI voltage (RFI current) at the frequency of the subrange maximum within the measuring time defined by option 42. Option 42 automatically switches on the Pk detector during prescan.

Option 45 Final QP/Av = ON: Final measurement of the RFI voltage (RFI current) within the measuring time defined by option 45. This option automatically switches on special function 30 (Pk + Av) during the prescan, i.e., with AV maximum of the subrange the final measurement is carried out using the Av detector, with Pk maximum of the subrange the QP detector is used for final measurement.

Option 62 Meas + Plot = ON: The interference spectrum is output on plotter simultaneously with the measurement.

3.4.4 RFI-Fieldstrength Measurements in the Frequency Range up to 30 MHz

a) Test Setup

RFI-fieldstrength measurements in line with the commercial standards are performed in the frequency range from 9 kHz to 30 MHz using the R&S-Loop Antenna HFH2-Z2. The shielded room offers the advantage of preventing ambient interferences, it may however impair the magnetic field especially in the case of small dimensions. Therefore, measurements in the shielded room can usually not replace open air tests.

Test Setup with Measurements in the Shielded Room

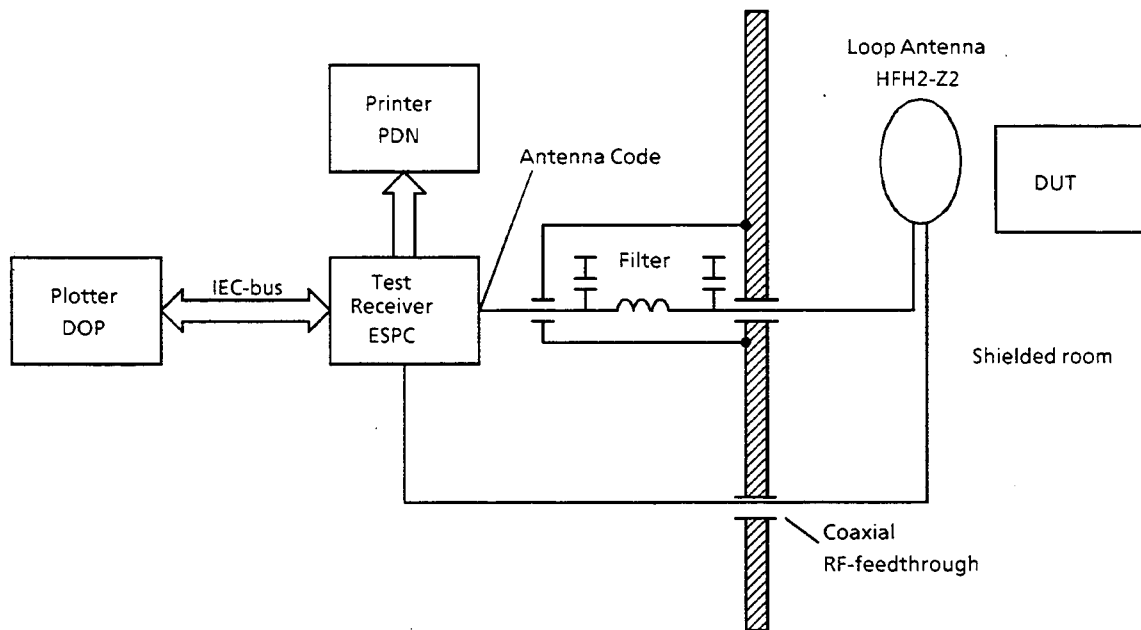

Fig. 3-54 Block diagram of a test setup with the Loop Antenna HFH2-Z2 and device under test in the shielded chamber

For the Loop Antenna HFH2-Z2 the supply voltages + 10 V and -10 V, the codings of the antenna factor and of the dimension "electric fieldstrength" ($\text{dB}\mu\text{V}/\text{m}$) must be fed through the wall of the shielded room. The connecting cables HZ-3 (3 m) and HZ-4 (10 m) can be used for this purpose.

If the magnetic fieldstrength is indicated in $\text{dB}\mu\text{A}/\text{m}$, a transducer factor of -31.5 dB must be entered.

Proposed arrangement of the connecting cables EZ-13 | EZ-5 | EZ-6

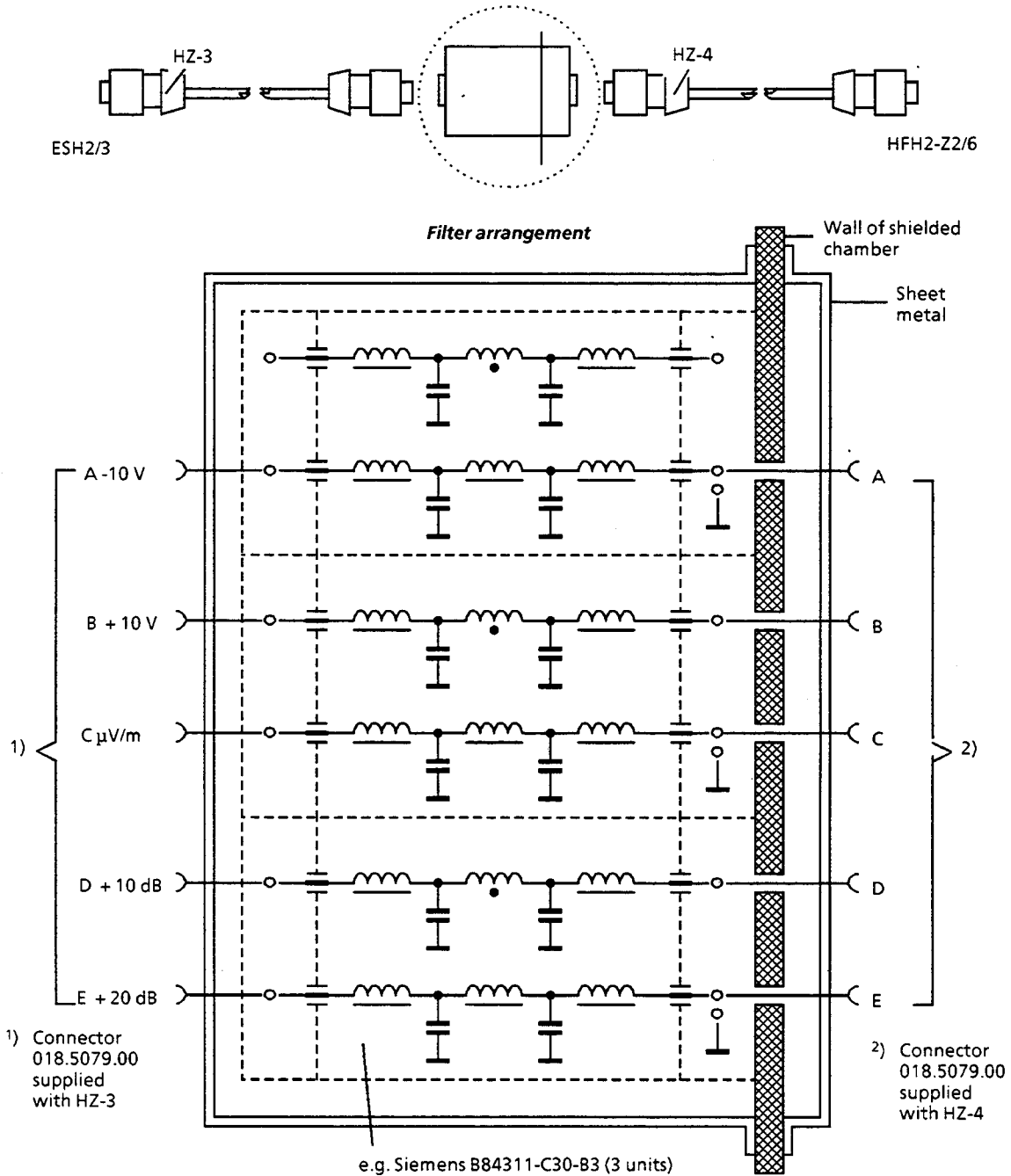

Fig. 3-55 Arrangement of the connecting cables HZ-3/4 with AF-filters for supplying and coding the Active Antennas HFH2-Z2 and -Z6 in shielded rooms

Note: *If the connectors are arranged favourably, the AF filters can also be used for control of the artificial mains networks (cf. section 3.4.1).*

If the transducer factor is used, the feedthroughs of the coding lines can be dispensed with. If the power supply unit is used for the Active Antenna HZ-9 inside the shielded room, the feedthroughs for the supply voltages can also be dispensed with.

Test Setup with Open Air Measurements:

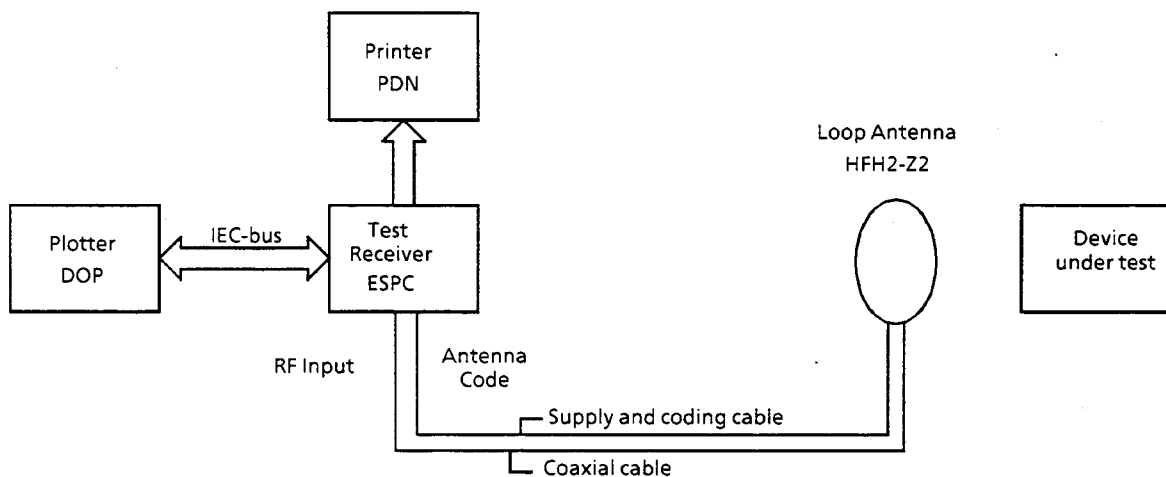

Fig. 3-56 Block diagram of a test setup with open air test. Make sure that the antenna is isolated from printer and plotter.

b) Setting of the Test Receiver

An automatic scan can only be recommended for measurements carried out in the shielded room, for example as a pre-measurement to roughly determine the fieldstrength and interference frequencies and subsequently check on individual frequencies in open air.

Measurement configurations need not be specified. Before starting the scan it is useful to align the antenna and device under test to maximum level indication of the frequency with the highest RFI fieldstrength (e.g. on the operating frequency of a switching power supply or on the line frequency of a screen).

The scan setting determines the run of the **Prescan**. The setting data recommended in section 3.4.1 are also true in this case. Pk must however be used as detector since there is only one QP-limit value.

The **data reduction** is defined by option 30.

For the **final measurement** option 42 (measuring again with QP-detector) is usually suitable.

The option 62 specifies whether the interference spectrum is plotted during or only following the measurement.

c) Measurement Sequence, Measurement and Analysis Procedure

The explanations given in section 3.4.1 are also valid for RFI-fieldstrength measurements, however without phase selection.

3.4.3 RFI Fieldstrength Measurement in the Frequency Range above 30 MHz

RFI fieldstrength measurements are usually performed at open air test systems in the range from 30 to 1000 MHz at a distance of 3, 10 or 30 m from the device under test. Linear polarized broadband dipoles are used as antennas with horizontal and vertical polarization. Generally, two antennas are used, e.g. a HK116 (30 to 300 MHz) together with a HL 223 (200 to 1000 MHz) or the broadband dipole HUF-Z1 (30 to 80 MHz) together with the log-periodic antenna HL 023 A1 (80 to 1000 MHz).

The fieldstrength measuring systems provide a conductive basal surface and must provide a system attenuation within narrow tolerance limits. There are only few perfect test systems in shielded (absorber) halls, since the required absorbers are quite expensive. Due to the conductive surface the fieldstrength does not only depend on polarization but also on height. Therefore, the antenna must be varied in height between 1 and 4 m. Since the device under test itself emits a directional radiation, it has to be turned in the various directions and, if necessary, be operated at different operating modes and with different cord arrangements. The influence of ambient interferences, which are often intermittent, i.e. not time-constant, on free-field test systems must also be taken into account.

A fully automatic measuring sequence using a test receiver without the aid of a controller is thus not suitable. This is why R&S offers the following solution using the ESPC:

A prescan is performed inside an acceptably shielded absorber hall without varying the height of the antenna (e.g. in the near-field at a distance of 1 m from the device under test) for searching the subrange maxima, which are then stored in the CMOS-RAM for subsequent manual open air measurement. If a semi-anechoic chamber is available, the optimum height should be selected.

a) Test Setup for RFI Fieldstrength Measurement

The device under test together with the antenna are placed in a shielded room, whereas the test receiver with its peripherals should be placed outside. The arrangement of the device under test including all lines connected should be identical with that of the free-field measurement. The antenna should be situated in the main radiation direction of the device under test.

The position of the antenna is recommended to be below 45 degrees (i.e. not horizontal or vertical) for the prescan. In this case one test run is sufficient.

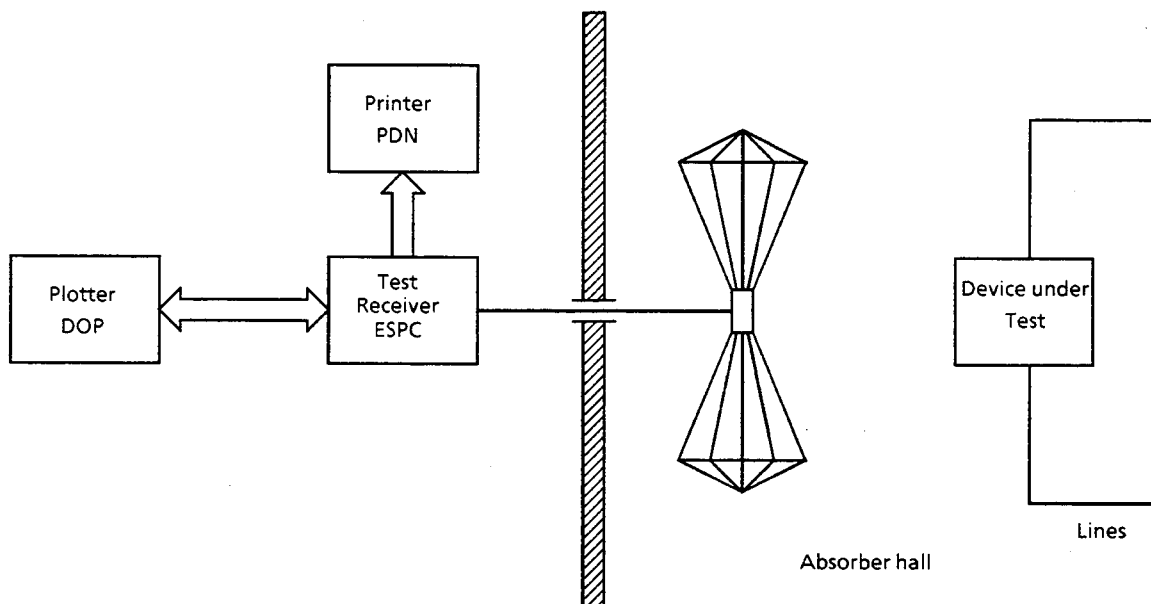

Fig. 3-57 Test setup for RFI fieldstrength measurement in an absorber hall

In the case of free-field measurements, the device under test may be positioned on a manually or remote-controlled turntable. The arrangement of lines to the device under test is to be looked up

in the valid testing regulations. The mast of the antenna and the turntable should be controllable at the test receiver location. Make sure that the test system (test receiver and peripherals) are reflection-free.

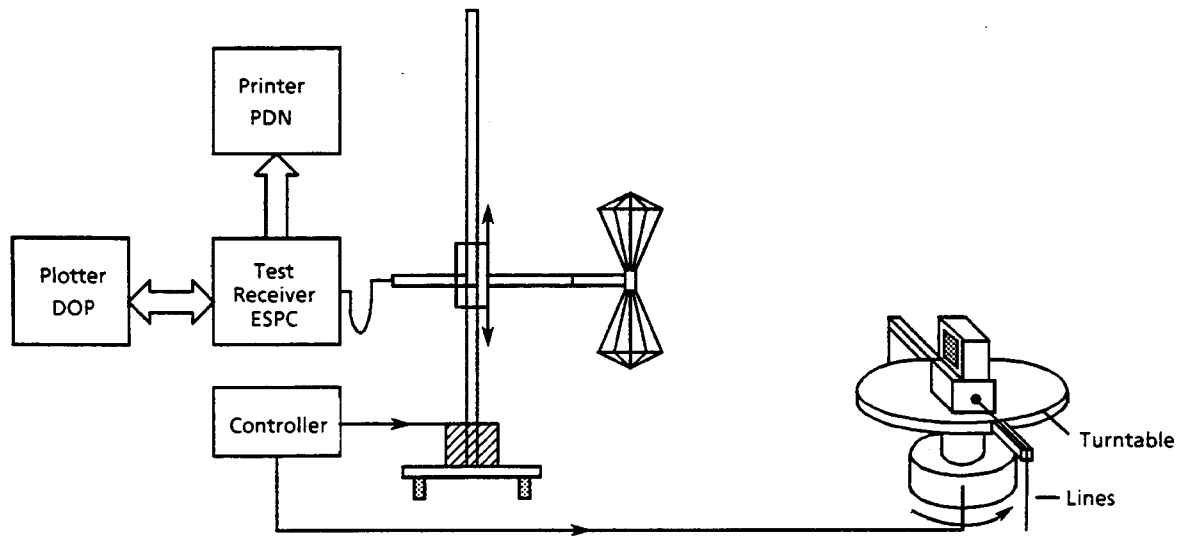

Fig. 3-58 Test setup for free-field RFI field strength measurement

b) Setting of the Test Receiver

The scan setting of the test receiver determines the data of the prescan.

Scan data:

Frequency range/MHz	30 - 1000
Stepsize/kHz	60 1)
Bandwidth (IF BW)/kHz	120
Detector	Pk
Meas. Time/s	02 2)
Attenuation	Auto Low Noise
Operating Range/dB	60

- 1) With pure broadband interference, frequency-proportional step size (LOG step) can be used instead of steps half the bandwidth.
- 2) The measuring time per measured value is determined by the type of interference signal. It should be selected such that the highest value is recorded in the case of time-dependent variations. Minimum measuring times of 20 or 10 ms are therefore required for network-synchronous pulse interferences (50 Hz or 100 Hz).

The subsequent scan options are used for RFI fieldstrength measurements:

06 *E-Field ShR*

A pre-measurement of the fieldstrength spectrum is performed in a shielded room which is subsequently repeated semi-manually at a free-field test system.

- 30 Subrge/Margin is determined as explained in the introduction to this section.
Useful settings:

No of Subranges 25, 50 or 100

Acc. Margin/dB 6

- 40 The options 40 to 45 determine the type of detector for final measurement. Fieldstrength limit values generally apply for the QP detector. Option 42 Final QP is activated by the default setting of option 06.

Note: *Since the prescan is often performed in the near field of the device under test, the limit value curve may be set differently for the prescan and for the free-field measurement. A new determination of the limit value must then be carried out with the final measurement.*

c) Test Run, Measurement and Analysis Procedure

- ▶ The prescan is initiated by pressing the RUN/STOP key.
It can be interrupted by pressing this key once and aborted by pressing the key twice (cf. section 3.2.4.3.4).
The following message is output at the ESPC:

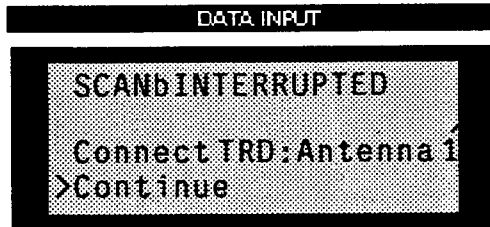

Name of the antenna 1), e.g. HK116

1) If the frequency range of only one antenna is scanned, the prescan is started immediately without this message being read out. Connection of all transducers is requested, ("Connect Antenna 1" and then "Connect Cable"), if the cable is used with the antennas.

- ▶ Press one of the ENTER keys
The prescan runs until the frequency is reached where antennas are switched over with determination of the subrange maxima (Pk) and read-out of the message *SCAN Running....*

Note: The RFI fieldstrength spectrum can be recorded by a plotter connected using option 62.

With the beeper activated (special function 13, beeper on) and a demodulation mode (FM, AM, ZERO BEAT) selected, the following display is output together with a beep when changing the antenna:

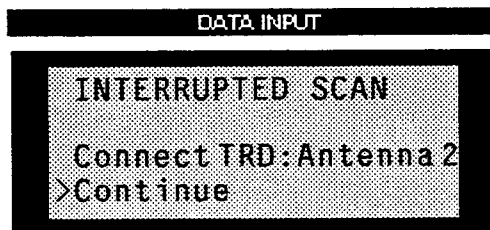

Name of the antenna, e.g. HL223

Press one of the ENTER keys. The prescan is continued until the end.

All subrange maxima are/will be stored in the CMOS-RAM. The list of the subrange maxima can be output as list of measured values, if required.

Measured value tables with RFI fieldstrength measurement (subsequent to the prescan):

Frequency MHz	Pk Level dB μ V/m	Pk Limit dB μ V/m
31.3000	41.4	45.1
37.4500	47.3*)	45.7
51.3500	44.5	46.5

*) limit exceeded

The list of frequencies can also be edited (same editor as for option 63) and thus modified. The min. and max. levels as well as the min. and max. frequencies of the prescan (default) are received, they can, however, be varied during the editing process. It is not suitable to enter the results of the final measurement into the graph of the pre-measurement, if both results have been acquired under different circumstances (different distances, resonances inside the shielded room) and different limit values apply. The new limit values can be activated before starting the Final Test.

The open air test system allows for performing the final measurement by starting the Final Test:

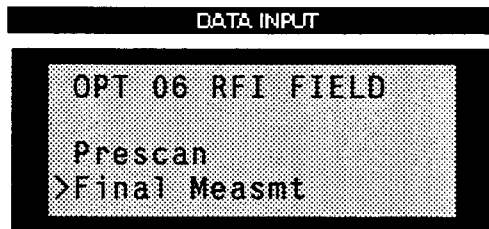

- ▶ Position the cursor at *Final Measmt*
- ▶ .Press one of the ENTER keys.

Note: If the prescan is started by mistake, the stored measured values are lost.

If the frequencies stored require more than one antenna to be connected, this is indicated by a beep and the request:

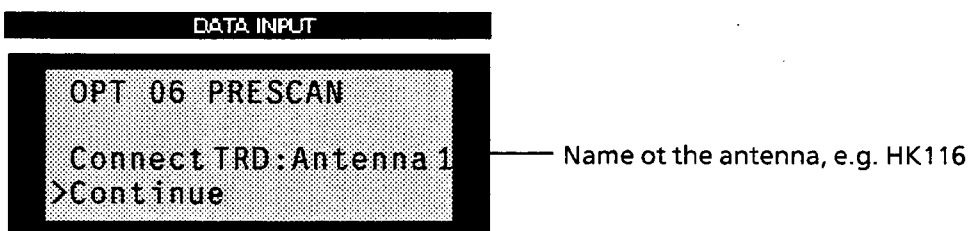

- ▶ Varyate the frequency using the rotary knob to trace drifting interferences. The currently set frequency is entered into the list of measuring values. If the same frequency with the same detector (measuring bandwidth) is set twice during the searching procedure the frequency with the lower level is suppressed. Therefore, the list does not contain the same frequency twice.

Upon start of the measurement the ESPC sets the frequency of the subrange maximum and the QP detector (option 42).
The display reads out:

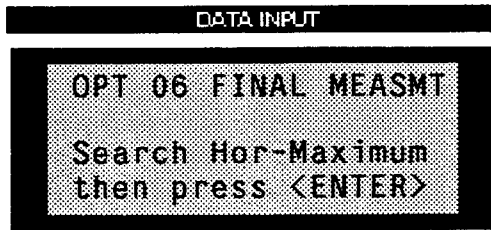

- ▶ With horizontal polarization, the height of the antenna and the azimuth of the turntable have to be varied until the max. ambient interference has been found.
- ▶ Press one of the ENTER keys.
The value indicated in the LEVEL display is stored.

Note: If the spurious emissions of the device under test cannot be measured due to ambient interference, another frequency can be set using the → key.

After storing the horizontal maximum the following request is output:

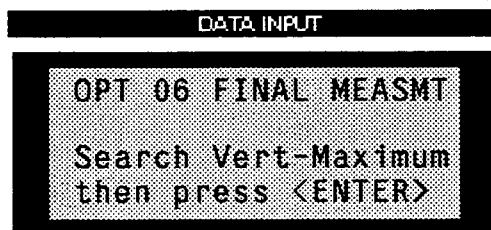

- ▶ With vertical polarization, the height of the antenna and the azimuth of the turntable have to be varied until the vertical maximum of the ambient interference has been found.
- ▶ Press one of the ENTER keys.
The value is indicated in the LEVEL display and output on the plotter as " + ". The ESPC then sets the next frequency, etc.

Returning to a previously set frequency is possible by pressing the ← key. The operator is thus enabled to repeat a measurement under different operating conditions of the device under test and can write a new value for a value stored inadvertently by pressing the ENTER key.

Tables of measured values with RFI fieldstrength measurement after performing the Final Test:

Frequency MHz	QP Level hor. dBµV/m	QP Level vert. dBµV/m	QP Limit dBµV/m
31.3000	41.4	39.1	45.5
37.4500	47.3*	43.3	45.7
51.3500	44.5	47.6*	46.5

* limit exceeded

3.4.6 RFI Power Measurement Using the Absorbing Clamp

According to the standards CISPR 14 and VDE 0875 part 1 the RFI power at the signal and supply lines exceeding a length of 1 m is to be measured within the frequency range 30 to 300 MHz. The absorbing clamp MDS 21 is used for this measurement. It is supplied with the transducer factor for determination of the RFI power in dBpW using the RFI voltage indicated by the test receiver in dBIJV. The signal and supply lines are lengthened to approx. 6 m (= half the wavelength at 30 MHz (5m) + length of the clamp). The clamp has to be slid by half the wavelength up to the maximum indication at the test receiver, respectively. Strictly speaking, the complete spectrum would have to be measured at each position (every 10 cm). This would, however, lead to unacceptably long measuring times.

The entire frequency range is divided up into a sufficient amount of subranges instead, featuring nearly the same conditions for all frequencies (i.e., source and load impedances are nearly equal)

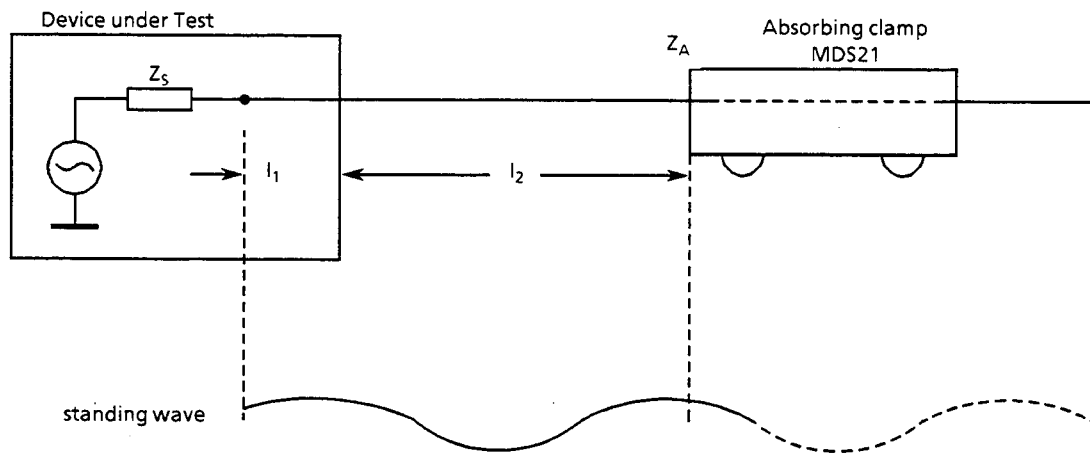

Fig. 3-59 Impedances Z_S and Z_A and lengths of the lines l_1 and l_2 with RFI power measurement. Z_S , Z_A and l_1 are nearly constant within one subrange; it is thus sufficient to determine the local maximum l_2 of the subrange maximum.

It can be assumed that the standing wave of the subrange maximum (maximum level of the subrange spectrum with fixed clamp) has its local maximum (the first maximum occurring with sliding the clamp) at the same location as all the other frequencies of this subrange and that all level relations within the frequency subrange remain nearly constant. That is why it is not necessary to determine the local maximum for each frequency of the subrange, since the levels are always below the level of the local maximum of the frequency subrange maximum. The subrange maximum thus becomes the representative frequency of the frequency subrange.

The current entering into the clamp never becomes 0, since the clamp does not terminate the interference source with a high impedance. That is why the entire spectrum can be covered at one position by an Acceptance Margin of approx. 10 dB - definitively at 0-position. Entering 16 or 25 for the number of subranges, e.g., is sufficient to minimize the amount of errors.

a) Test Setup

To avoid measurement errors due to ambient interference the device under test and the measuring sensor (absorbing clamp) should be operated in a shielded room, however, for example, cellar rooms with low ambient interference are often sufficient. Due to its low radiation the test receiver ESPC can be set up inside the shielded room. Simultaneous operation of a printer and/or plotter may, however, cause problems. In this case the test report should be output subsequent to the measurement or the ESPC together with printer and plotter should be operated outside the shielded room.

It should be possible to move the absorbing clamp at the test receiver. This could be achieved by rollers supporting the clamp and a cord connecting the clamp to the test receiver.

It is useful to mark the measuring table with a frequency scale such that the frequency value is entered at a distance of half the wavelength from the device under test, respectively, i.e., "300 MHz" with 0.5 m; "200 MHz" with 0.75 m; "150 MHz" with 1 m; "100 MHz" with 1.5 m; ... "30 MHz" with 5 m. The operating range of the clamp decreases with increasing frequency.

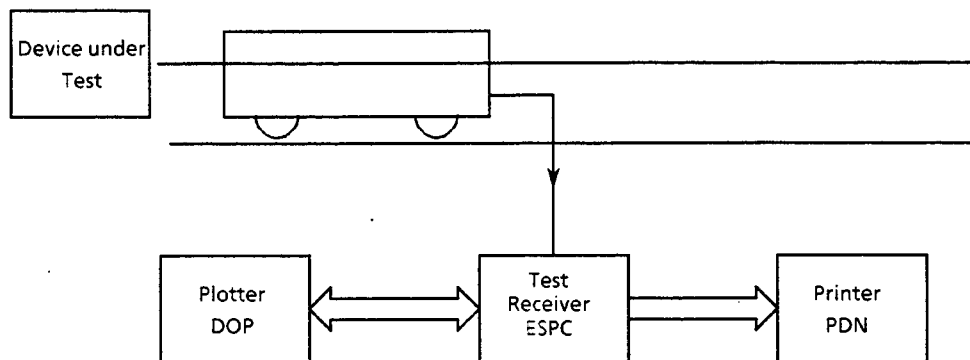

Fig. 3-60 Block diagram of a test setup with MDS clamp and device under test in a shielded room

Detailed information on the height of the measuring table, the distance between MDS clamp and wall etc., can be looked up in the latest versions of the respective standards.

b) Setting of the Test Receiver

The scan setting of the test receiver determines the data of the prescan. For RFI power measurements it covers a range from 30 to 300 MHz.

Scan data:	
Frequency range/MHz	30 - 300
Stepsize/kHz	60 ¹⁾
Bandwidth (IF BW)/kHz	120
Detector	PK + AV ²⁾
Meas. Time/s	.02 ³⁾
Attenuation	Auto Low Noise
Operating Range/dB	60

- 1) With pure broadband interference, frequency-proportional step size (LOG step) can be used instead of steps half the bandwidth.
- 2) For measurements according to standards with narrowband and broadband interference limit values or average and quasipeak limit values, the special function 30 allowing for simultaneous measurement of peak and average value during one scan is useful. If there is only one limit value, it is sufficient to switch on one detector only, e.g. Pk or Av.
- 3) The measuring time per measured value is determined by the type of interference signal. It should be selected such that the highest value is recorded in the case of time-dependent variations. Minimum measuring times of 20 or 10 ms are therefore required for network-synchronous pulse interferences (50 Hz or 100 Hz).

The subsequent scan options are used for RFI power measurements:

- 04 *RFI Power*
RFI power measurement
Enables interactive measurement at the subrange maxima subsequent to the prescan, if one of the options 40 to 45 is selected.
The conversion factor of the MDS clamp is to be entered via the transducer factor.
- 30 *Subrange/Margin* is determined as explained in the introduction to section 3.4. Suitable settings:
No of Subranges 16 or 25
Acc. Margin/dB 10
- 40 The options 40 to 45 determine the type of detector for final measurement.

c) Test Run, Measurement and Analysis Procedure

- ▶ Press the RUN key. The following request is read out on the DATA INPUT display:

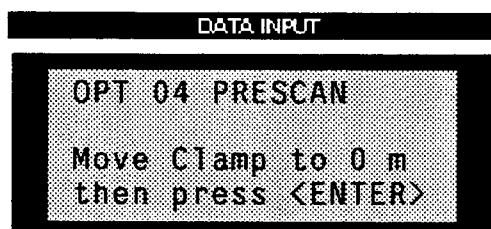

- ▶ Move the clamp as near as possible to the device under test and press one of the ENTER keys. The prescan is started and runs to the stop frequency with determination of the subrange maxima (Pk and/or Av) reading out the message SCAN Running....The interference spectrum can be output on plotter using option 62. The end of the prescan is indicated by a beep, then the first frequency and the detector of one of the options 40 to 45 are set and the following request is output:

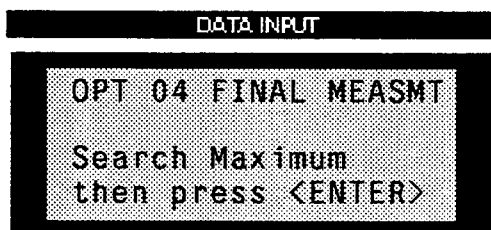

- ▶ Vary the frequency using the rotary knob to trace drifting interferences. The currently set frequency is entered into the list of measuring values. If the same frequency with the same detector (measuring bandwidth) is set twice during the searching procedure the frequency with the lower level is suppressed. Therefore, the list does not contain the same frequency twice.
- ▶ Slide the clamp while watching the pointer of the analog indication until the maximum has been found.
- ▶ The value currently indicated on the LEVEL display is stored in the measured value memory and output on plotter as * or +. Then the ESPC sets the next frequency etc. (It is also possible to perform two measurements at the same frequency, if the AV subrange maximum and the PK subrange maximum with SF 30 are at the same frequency).

- A list of the measured values can be output on plotter or on printer, as shown by the subsequent example (This table applies for option 45 by way of example. The AV table is not listed, when option 42 is selected. When option 40 is selected the QP table is omitted.):

Frequency MHz	QP Level dBpW	QP Limit dBpW
31.3000	41.4	45.1
37.4500	47.3*	45.7
51.3500	44.5	46.5

Frequency MHz	AV Level dBpW	AV Limit dBpW
34.25	38.3*	35.3
37.45	43.5*	35.7

* limit exceeded

Note: *With option 45 the higher limit is always the QP limit. If no limit value line is activated, the respective column heading is omitted.*

3.5 Program Examples

The examples given in this section illustrate how to program the test receiver and may be the foundation for the solution of more complex spheres of measurement. The examples are based on each other step by step and each one is explained.

The programming language used is the Rohde & Schwarz-BASIC from version 2.00 onward. It is, however, possible to translate the programs into other languages.

3.5.1 Initialization and Initial State

At the beginning of every program, the IEC-bus and the settings of the receiver should be brought into a defined default status. It is helpful to use subprograms, in this case "Prolog" and "Init_ESVS".

The controller terminator should be set to "linefeed" (decimal 10), which - together with EOI - is the only permissible terminator according to the standard IEEE 488.2 and is also made use of in the ESVS.

```
10000 '
10010Prolog:
10020 '
10030     IEC TERM 10: '           Linefeed
10040     IEC TIME 1000: '       Timeout 1s
10050 '
10060     Espc=18: '             Receiver IEC address
10070 '
10080 '                           other initialization
10090 '
10100 RETURN
10110 '-----
```

Die IEC-Bus-Status-Register und Geräteeinstellungen des Empfängers werden in einem weiteren Unterprogram in den Grundzustand gebracht:

```
11000 '
11010Init_espc:
11020 '
11030 '                           reset status registers
11040     IEC OUT Espc,"*CLS"
11050 '
11060 '                           reset Receiver settings
11070     IEC OUT Espc,"*RST"
11080 '
11090 '                           init other devices
11100 '
11110 RETURN
11120 '-----
```

3.5.2 Sending a Device Setting Command

In this example some settings of the receiver section are made: frequency, RF-attenuation and demodulator.

```
100 '-----
110 '      Send Receiver settings
120 '-----
130 '
140 GOSUB Prolog
150 GOSUB Init_esp
160 '                                     send new settings
170 IEC OUT Espc,"FREQUENCY 20 MHZ"
180 IEC OUT Espc,"ATTENUATION 30 DB;DETECTOR PEAK"
190 '
200 END
210 '-----
10000 '
10010Prolog:
10020 '
10030   IEC TERM 10: '                   Linefeed
10040   IEC TIME 1000: '                 Timeout 1s
10050 '
10060   Espc=18: '                       Receiver IEC address
10070 '
10080 '                                     other initialization
10090 '
10100 RETURN
10110 '-----
11000 '
11010Init_esp:
11020 '
11030 '                                     reset status registers
11040   IEC OUT Espc,"*CLS"
11050 '
11060 '                                     reset Receiver settings
11070   IEC OUT Espc,"*RST"
11080 '
11090 '                                     init other devices
11100 '
11110 RETURN
11120 '-----
```

The subprograms "Prolog" and "Init_ESVS" still integrated in this example will no longer be part of the following examples.

3.5.3 Reading of the Device Settings

The settings made in the preceding example are read in this program. The commands are used in short form for this purpose.

```
100 '-----
110 '      Read Receiver settings
120 '-----
130 '
140 GOSUB Prolog
150 '
160 '                                read settings
170 IEC OUT Espc,"FR?"
180 IEC IN Espc,Frequency$
190 '
200 IEC OUT Espc,"A?"
210 IEC IN Espc,Rf_attenuation$
220 '
230 IEC OUT Espc,"DET?"
240 IEC IN Espc,Detector$
250 '                                print settings on screen
260 PRINT Frequency$
270 PRINT Rf_attenuation$
280 PRINT Detector$
290 '
300 END
```

In line with the settings that have been made earlier, the following indication results:

```
FREQUENCY 20000000
ATTENUATION 30
DETECTOR PEAK
```

3.5.4 Triggering a Single Measurement and Synchronization using *WAI

In this case a level measurement at a frequency previously set is started using the common command *TRG. *WAI serves to delay the processing of further commands until all the previous commands - in this case the level measurement - are executed. Only then is the result of the last measurement read in and indicated on the screen. When using *WAI, please note that the set timeout must be longer than the processing time of the commands, as otherwise an error message results. In this example the timeout of 1 s set in the prolog is sufficient for the default measuring time of 100 ms.

```
100 '-----
110 '   Trigger and read result
120 '-----
130 '
140 GOSUB Prolog
150 GOSUB Init_espc
160 '                               set frequency
170 IEC OUT Espc,"FREQUENCY 98.5 MHz"
180 '                               Trigger and Wait
190 IEC OUT Espc,"*TRG;*WAI"
200 '                               get result
210 IEC OUT Espc,"LEVEL:LASTVALUE?"
220 IEC IN Espc,Level$
230 '                               print result on screen
240 PRINT Level$
250 END
```

The output on the screen might be as follows:

LEVEL:LASTVALUE 23.87

To simplify this frequently used sequence, the ESVS offers the command LEVEL?, which synchronizes internally level measurement and retrieving of the measured value. It substitutes for the commands *TRG;*WAI;LEVEL:LASTVALUE?. The synchronization mechanism described above can also be applied to all other commands.

3.5.5 Service Request Routine

The smartest and most flexible way of synchronization of sequences is offered by the Service Request.

It requires an interrupt routine being part of the program of the system controller. The routine can be serviced asynchronously to the usual program run, if a Service Request occurs.

In the case of this subprogram the device(s) having sent the Request can be identified by their status bytes when polling the devices that might have sent one. Subsequently the appropriate measures can be taken.

To activate the interrupt capability of the controller, the command

```
nnn ON SRQ GOSUB label
```

must be added to the main program.

Service Request Routine:

```
12000 '-----
12010 '   Service Request Routine
12020 '-----
12030 Srq_routine:
12040 '                               Serial Poll
12050 '   IEC SPL Espc,Sb%
12060 '                               Check SRQ-Bit
12070 IF (Sb% AND 64) THEN
12080 '                               SRQ-Flag TRUE
12090 '   Srq%=1
12100 '                               e.g. check registers
12110 ELSE
12120 '                               poll other devices
12130 ENDIF
12140 '                               enable SRQ Interrupt and return
12150 '                               in the same line to avoid nesting!
12160 '
12170 ON SRQ GOSUB Srq_routine: RETURN
```

This very simple Service Request routine can be extended for the respective applications. It includes the operation of other devices connected to the bus or the weighting of additional IEC-bus register or error recoveries.

If a Service Request is to be generated at the end of processing of a command, the Event Status Enable register ESE and Service Request Enable register must be configured correspondingly.

The command *OPC sets the bit 0 in the Event Status register. Analog to this setting, the bit 0 in the Event Status Enable register must be set. Bit 5 in the Service Request Enable register must finally be set to enable a Service Request.

3.5.6 Synchronization with the End of the Scan using *OPC

In this example a scan, the end of which is waited for with the help of the command *OPC, is triggered. The end can be identified by the flag Srq% which is set in the Service Request routine. The registers stated in the before-mentioned example are previously configured.

```
100 '-----
110 '      Execute Scan
120 '-----
130 '
140   GOSUB Prolog
150   GOSUB Init_espc
160 '
170   GOSUB Exec_scan
180 '
190 END
3000 '-----
3010 '      Execute Scan and wait for Operation Complete
3020 '-----
3030 Exec_scan:
3060 '                               Init SRQ-Routine
3070   ON SRQ1 GOSUB Srq_routine
3080 '                               Config Registers
3090   IEC OUT Espc,"*CLS;*ESE 1;*SRE 32"
3100 '                               Init SRQ-Flag
3110   Srq%=0
3120 '                               Start Scan
3130   IEC OUT Espc,"SCAN:RUN;*OPC"
3140 '
3150 '                               Do something useful
3160 '                               while scanning
3170 '
3180   REPEAT
3190 '                               Do something useful too
3200 '                               or just wait
3210   UNTIL Srq%
3220 '                               Scan is completed
3230 RETURN
```

3.5.7 Programming a Scan Data Set

In this example a scan data set for RF analysis consisting of two ranges is defined. The appertaining receiver settings are made and the level range displayed in the diagram is set.

```
100 '-----
110 '      Set Scan Data
120 '-----
130 '
140   GOSUB Prolog
150   GOSUB Init_espc
160 '
170   GOSUB Prog_scan
180 '
190 END
2000 '-----
2010 '      Define Settings for RF Analysis
2020 '-----
2030Prog_scan:
2060 '
2070 '                      define grid
2080   IEC OUT Espc,"GRID:FREQAXIS LOG"
2090   IEC OUT Espc,"GRID:MINLEVEL -20 dB"
2100   IEC OUT Espc,"GRID:MAXLEVEL 80 dB"
2110 '
2120 '                      2 scan ranges
2130   IEC OUT Espc,"SCAN:RANGES 2"
2140 '
2150 '                      linear steps
2160   IEC OUT Espc,"SCAN:FREQUENCY:STEPMODE LIN"
2170 '
2180 '                      define frequency ranges
2190   IEC OUT Espc,"SCAN 1"
2200   IEC OUT Espc,"SCAN:FREQUENCY:START 20 MHz"
2210   IEC OUT Espc,"SCAN:FREQUENCY:STOP 100 MHz"
2220   IEC OUT Espc,"SCAN:FREQUENCY:STEPSIZE 10 kHz"
2230 '
2240   IEC OUT Espc,"SCAN 2"
2250   IEC OUT Espc,"SCAN:FREQUENCY:STOP 500 MHz"
2260   IEC OUT Espc,"SCAN:FREQUENCY:STEPSIZE 100 kHz"
2270 '
2280   IEC OUT Espc,"SCAN:SAVE"
2290 '
2300 '                      define receiver settings
2310   IEC OUT Espc,"SCAN 1"
2320   IEC OUT Espc,"SCAN:RECEIVER:DETECTOR PEAK"
2330   IEC OUT Espc,"SCAN:RECEIVER:BANDWIDTH:IF 10 kHz"
2340   IEC OUT Espc,"SCAN:RECEIVER:MEASUREMENT:TIME 100 ms"
2350   IEC OUT Espc,"SCAN:RECEIVER:ATTENUATION:AUTO ON"
2360   IEC OUT Espc,"SCAN:RECEIVER:ATTENUATION:MODE LOWNOISE"
2370   IEC OUT Espc,"SCAN:RECEIVER:RANGE 60 dB"
2380 '
2390 '
2400 '
2410   IEC OUT Espc,"SCAN 2"
2420   IEC OUT Espc,"SCAN:RECEIVER:DETECTOR PEAK"
2430   IEC OUT Espc,"SCAN:RECEIVER:BANDWIDTH:IF 120 kHz"
2440   IEC OUT Espc,"SCAN:RECEIVER:MEASUREMENT:TIME 20 ms"
2450   IEC OUT Espc,"SCAN:RECEIVER:ATTENUATION:AUTO ON"
2460   IEC OUT Espc,"SCAN:RECEIVER:ATTENUATION:MODE LOWNOISE"
2470   IEC OUT Espc,"SCAN:RECEIVER:RANGE 60 dB"
2480 '
2490 '
2500 '
2510 '
2520 RETURN
```

3.5.8 Programming a Transducer Factor

A transducer factor for an antenna is stored as transducer factor No. 1 in this example. The name and unit are additionally specified.

```
100 '-----
110 '      Transducer Factor
120 '-----
130 '
140   GOSUB Prolog
150   GOSUB Init_espc
160 '
170   GOSUB Prog_tfactor
180 '
190 END
1000 '-----
1010 '      Define Transducer Factor and activate
1020 '-----
1030 Prog_tfactor:
1040   GOSUB Prolog
1050   GOSUB Init_espc
1060 '
1070 '                                define values
1080 DIM Frequency(10)
1090 DIM Level(10)
1100 '
1110 Frequency(0)=20E6: Level(0)=15.7
1120 Frequency(1)=25E6: Level(1)=17.6
1130 Frequency(2)=30E6: Level(2)=13.6
1140 Frequency(3)=35E6: Level(3)=12.1
1150 Frequency(4)=40E6: Level(4)=12.2
1160 Frequency(5)=45E6: Level(5)=11.2
1170 Frequency(6)=50E6: Level(6)=10.3
1180 Frequency(7)=55E6: Level(7)=9.7
1190 Frequency(8)=60E6: Level(8)=8.2
1200 Frequency(9)=65E6: Level(9)=7.4
1210 '
1220 '
1230 '                                select factor
1240   IEC OUT Espc,"TRANSDUCER:FACTOR 1"
1250 '
1260 '                                transducer name
1270   IEC OUT Espc,"TRANSDUCER:FACTOR:TEXT 'antenna1'"
1280 '
1290 '                                transducer unit
1300   IEC OUT Espc,"TRANSDUCER:FACTOR:UNIT DBUV_M"
1310 '
1320 '                                build command string
1330 '
1340   Transducer$="10": '                                number of values
1350   FOR I=0 TO 9 STEP 1
1360     Transducer$=Transducer$+", "+STR$(Frequency(I))+", "+STR$(Level(I))
1370   NEXT I
1380 '
1390 '                                transmit factor
1400   IEC OUT Espc,"TRANSDUCER:FACTOR:DEFINE "+Transducer$
1410 '
1420 '                                activate factor
1430   IEC OUT Espc,"TRANSDUCER:FACTOR:SELECT 1"
1440 '
1450 RETURN
1460 '-----
```

3.5.9 Programming a Transducer Set

A transducer set consisting of two ranges is created from transducer factors defined before. The transducer factors used must be defined for the frequency range of the selected transducer set range.

In this example two factors each are put together to form a set range. These two factors might be an antenna with cable, for example.

The start frequency of the second range is defined by the stop frequency of the first range.

```
100 '-----
110 '      Transducer Set
120 '-----
130 '
140   GOSUB ProLog
150   GOSUB Init_espc
160 '
170   GOSUB Prog_tset
180 '
190 END
1000 '-----
1010 '      Define Transducer Set and activate
1020 '-----
1030Prog_tset:
1040 '
1050 '                      select set
1060   IEC OUT Espc,"TRANSDUCER:SET 1"
1070 '
1080 '                      transducer set name
1090   IEC OUT Espc,"TRANSDUCER:SET:TEXT 'RFI test'"
1100 '
1110 '                      transducer unit
1120   IEC OUT Espc,"TRANSDUCER:SET:UNIT DBUV_M"
1130 '
1140 '                      define ranges
1150   IEC OUT Espc,"TRANSDUCER:SET:RANGES 2"
1160 '
1170 '                      select transducer factor
1180 '                      4 and 7 for range 1
1190   IEC OUT Espc,"TRANSDUCER:SET:RANGES:NUMBER 1"
1200   IEC OUT Espc,"TRANSDUCER:SET:RANGES:START 20 MHz"
1210   IEC OUT Espc,"TRANSDUCER:SET:RANGES:STOP 150 MHz"
1220   IEC OUT Espc,"TRANSDUCER:SET:RANGES:DEFINE 2,4,7"
1230 '
1240 '                      select transducer factor
1250 '                      5 and 9 for range 2
1260   IEC OUT Espc,"TRANSDUCER:SET:RANGES:NUMBER 2"
1270   IEC OUT Espc,"TRANSDUCER:SET:RANGES:STOP 500 MHz"
1280   IEC OUT Espc,"TRANSDUCER:SET:RANGES:DEFINE 2,5,9"
1290 '
1300 '                      save set
1310   IEC OUT Espc,"TRANSDUCER:SET:SAVE"
1320 '                      activate set
1330   IEC OUT Espc,"TRANSDUCER:SET:SELECT 1"
1340 '
1350 RETURN
1360 '

```

3.5.10 Output of a Test Report on Plotter

To enable the receiver to output a test report on plotter via IEC bus, the receiver must be the IEC-bus controller. If output is started by a process controller, the pass-control protocol is used for this purpose.

This means that the receiver is transferred IEC-bus control by the process controller. After completion of plotter output the controller function is returned by the ESS. The receiver must previously be told the address of the process controller using pass-control-back command "*PCB address".

While the ESS has the controller function, the process controller is not disabled. IEC-bus functions requiring bus control are the only ones which cannot be performed by the process controller.

It waits for the receiver to return the controller function with the help of command "Wait Take Control" - WTCT.

```
100 '-----
110 '      Plot Test Report
120 '-----
130 '
140   GOSUB Prolog
150   GOSUB Init_espc
160 '
170   GOSUB Plot_report
180 '
190 END
1000 '-----
1010 '      Plot_report
1020 '-----
1030Plot_report:
1120 '                      Controller address
1130   Controller=30
1140 '
1150 '                      configure for Pass Control Back
1160   IEC ADR Controller
1170   IEC OUT Espc,"*PCB "+STR$(Controller)
1180 '
1190 '                      configure Test Report
1200 '                      diagram and heading
1210   IEC OUT Espc,"PLOTTER:CONTENT:DEFAULT ON"
1220 '
1230 '                      select pens
1240   IEC OUT Espc,"PLOTTER:SETUP:PEN ON"
1250   IEC OUT Espc,"PLOTTER:SETUP:PEN:GRID 2"
1260   IEC OUT Espc,"PLOTTER:SETUP:PEN:LIMIT 3"
1270   IEC OUT Espc,"PLOTTER:SETUP:PEN:CURVE1 4"
1280   IEC OUT Espc,"PLOTTER:SETUP:PEN:CURVE2 5"
1290   IEC OUT Espc,"PLOTTER:SETUP:PEN:TEXT 1"
1300   IEC OUT Espc,"PLOTTER:SETUP:PEN:DATE 4"
1310 '
1320 '                      special scaling off
1330   IEC OUT Espc,"PLOTTER:SETUP:FORMAT OFF"
1340 '
1350 '                      header
1360   IEC OUT Espc,"REPORT:HEADER:COMPANY      'Rohde & Schwarz'"
1370   IEC OUT Espc,"REPORT:HEADER:PROGRAM      'Conformance Test'"
1380   IEC OUT Espc,"REPORT:HEADER:EUT          'Machine'"
```

```

1390 IEC OUT Espc,"REPORT:HEADER:MANUFACTURER 'No Name'"
1400 IEC OUT Espc,"REPORT:HEADER:CONDITION 'green'"
1410 IEC OUT Espc,"REPORT:HEADER:OPERATOR 'M. Keller'"
1420 IEC OUT Espc,"REPORT:HEADER:SPEC 'internal #23'"
1430 IEC OUT Espc,"REPORT:HEADER:REMARK1 'comments'"
1440 IEC OUT Espc,"REPORT:HEADER:REMARK2 ''"

1450 '
1460 ' initiate Plot
1470 IEC OUT Espc,"PLOTTER:START"
1480 ' pass control to Receiver
1490 IEC TAD Espc: IEC TCT
1500 ' wait for plot complete
1510 ' and pass control back
1520 IEC WTCT
1530 '
1540 RETURN
1550 '

```

3.5.11 Block-Serial Output of the Scan Results in ASCII Format

In the following example a block-serial transfer of the measured values, which is proceeding with the measurement being executed, is carried out during the current RF analysis. The number of block elements to be simultaneously transferred is set to 20. "COMBINED" is selected for the type of data to be output, i.e. each level value measured is included in the data block together with all additional information. "ASCII" has been chosen as output format, i.e. the data are transferred in a string which can be read directly, e.g. "SCAN:BLOCK 0002,35,20000000,13.24,0,20100000,14.58,0". The first number indicates the number of following block elements, the second contains information on the composition of the block elements and is designated as template. All further numbers contain the actual measurement results, in this example frequency, level and the validity byte.

This format is most time-consuming in output, as the conversion of binary data into ASCII format requires a high amount of computing.

Extended event-status register ERD is used to indicate that enough new data have been collected. The status registers are set such that the setting of one bit in this register induces a service request. Thus the weighting of all this information is effected in the appertaining service-request routine.

A further bit of this register indicates that the last block has been transferred and thus supplies the signal for terminating the program. As soon as the poll of a block has been initiated using "SCAN:BLOCK?", the data are processed and formatted in the output buffer. In order to have sufficient time for that, the IEC-bus timeout is set to a value of 32 s.

Subroutines Prolog, Init_esp and Prog_scan have already been included in the preceding examples and are not listed here any more.

```
100 '-----
110 '   Transfer of Block Data in ASCII format
120 '-----
130 '
140   GOSUB Prolog
150   GOSUB Init_esp
160 '
170 '                                     Define settings for RF analysis
180   GOSUB Prog_scan
190 '
200   GOSUB Exec_scan
210 '
220 '
230 END
3000 '-----
3010 '       Execute Scan and wait for last block
3020 '-----
3030 Exec_scan:
3040 '                                     setup block format
3050   IEC OUT Espc,"SCAN:BLOCK:FORMAT  ASCII"
3060   IEC OUT Espc,"SCAN:BLOCK:ELEMENT  COMBINED"
3070   IEC OUT Espc,"SCAN:BLOCK:COUNT  20"
3080 '                                     config registers
3090   IEC OUT Espc,"*CLS;*ESE 1;*SRE 33"
3100 '                                     enable all bits
3110   IEC OUT Espc,"ERDE 65535"
3120 '                                     init variable
3130   Erd=0
3140 '                                     waste previous results
3150   IEC OUT Espc,"SCAN:RESULTS:CLEAR"
3160 '                                     Init SRQ-Routine
3170   ON SRQ1 GOSUB Srq_routine
3180 '
3190   IEC OUT Espc,"SCAN:RUN;*OPC"
3200   PRINT "Scan is running"
3210 '
3220 '
3230   REPEAT
3240 '                                     Wait for last block
```

```

3250 '                                     of scan results
3260   UNTIL Erd AND 4
3270 '
3280   PRINT "Transfer completed"
3290 '
3300 RETURN
4000 '-----
4010 '           Get data block
4020 '-----
4030Block_query:
4040 '                                     data query
4050   IEC OUT Espc,"SCAN:BLOCK?"
4060 '
4070 '                                     wait for data processing
4080   IEC TIME 32000
4090 '                                     get data
4100   IEC IN Espc,Block$
4110 '
4120 '                                     length of data block
4130   Count=LEN(Block$)
4140 '
4150 '
4160 RETURN
12000 '-----
12010 '   Service Request Routine
12020 '-----
12030Srqroutine:
12040 '                                     Serial Poll
12050   IEC SPL Espc,Sb%
12060 '                                     check SRQ bit
12070   IF (Sb% AND 64) THEN
12080 '----- check ERD bit
12090     IF (Sb% AND 1) THEN
12100 '                                     read ERD register
12110       IEC OUT Espc,"ERD?"
12120       IEC IN Espc,Erd$
12130       Erd=VAL(Erd$)
12140       PRINT "ERD:";Erd
12150 '----- check insufficient RAM bit
12160       IF (Erd AND 16) THEN
12170         PRINT "Insufficient RAM"
12180       ENDIF
12190 '----- check data ready bit
12200       IF (Erd AND 128) THEN
12210 '                                     read data block
12220         GOSUB Block_query
12230         Sum=Sum+(Count-1)
12240 '                                     print results
12250         PRINT Block$
12260         PRINT
12270         PRINT "-->";Sum;" bytes up to now"
12280       ENDIF
12290     ENDIF
12300 '----- check ESR Bit
12310     IF (Sb% AND 32) THEN
12320       PRINT "Operation complete"
12330 '                                     clear enable register
12340       IEC OUT Espc,"*ESE 0"
12350     ENDIF
12360   ELSE
12370 '----- poll other devices
12380   ENDIF
12390 '                                     enable SRQ Interrupt and return
12400 '                                     in the same line to avoid nesting!
12410 '
12420 ON SRQ1 GOSUB Srqroutine: RETURN

```

3.5.12 Block-Serial Output of the Scan Results in Binary Format

In this example the data are output in binary format. Here weighting is somewhat more difficult because the binary data are combined without a significant delimiter. Further, some components of a block element cannot be assigned a fixed position in the data block, as the results can be composed differently depending on the receiver setting.

The routine listed subsequently first evaluates the first two bytes of the data block, they contain the number of block elements in the data string, and then the next two bytes from whose content the parts a block element consists of are evident.

The FOR-NEXT loop, which performs the actual analysis of the block elements, can be made so universal - using these two pieces of information - that it is true of all types of block data possible. The index% variable is a pointer which always points to the date in the result string to be analyzed next and is switched further according to the size of the respective date.

Thus this single procedure in an application program is sufficient to cover all cases.

The output of a header is switched off as it is not required and would only make the analysis of the data more complicated.

What is particular is the weighting of the frequency. The receiver transfers the values in IEEE format for floating-point variables at twice the accuracy. The R&S BASIC uses the same internal kind of display of floating-point numbers. Instead of a time-consuming conversion it is thus possible to copy the bytes of the result string directly into BASIC's internal memory of variables using the VARPTR and POKE commands.

This principle can also be used in other programming languages if they themselves or a library, which can be connected in addition, support the IEEE-Double-Precision format.

```
100 '-----
110 '   Transfer of Block Data in binary format
120 '-----
130 '
140   GOSUB Prolog
150   GOSUB Init_espc
160 '
170 '                               Define settings for RF analysis
180   GOSUB Prog_scan
190 '
200   GOSUB Exec_scan
210 '
220 '
230 END
3000 '-----
3010 '       Execute Scan and wait for last block
3020 '-----
3030 Exec_scan:
3040 '                               setup block format
3050   IEC OUT Espc,"SCAN:BLOCK:FORMAT  BINARY"
3060   IEC OUT Espc,"SCAN:BLOCK:ELEMENT COMBINED"
3070   IEC OUT Espc,"SCAN:BLOCK:COUNT  20"
3080 '                               config registers
3090   IEC OUT Espc,"*CLS;*ESE 1;*SRE 33"
3100 '                               enable all bits
3110   IEC OUT Espc,"ERDE 65535"
3120 '                               init variable
3130   Erd=0
3140 '                               waste previous results
```

```

3150   IEC OUT Espc,"SCAN:RESULTS:CLEAR"
3160 '                                     supress header
3170   IEC OUT Espc,"HEADER OFF"
3180 '                                     terminator EOI for binary data
3190   IEC TERM 1
3200 '                                     Init SRQ-Routine
3210   ON SRQ1 GOSUB Srq_routine
3220 '
3230   IEC OUT Espc,"SCAN:RUN;*OPC"
3240   PRINT "Scan is running"
3250 '
3260 '
3270   REPEAT
3280 '                                     Wait for last block
3290 '                                     of scan results
3300   UNTIL Erd AND 4
3310 '
3320   PRINT "Transfer completed"
3330 '
3340 RETURN
4000 '-----
4010 '           Get data block
4020 '-----
4030Block_query:
4040 '                                     data query
4050   IEC OUT Espc,"SCAN:BLOCK?"
4060 '
4070 '                                     wait for data processing
4080   IEC TIME 32000
4090 '                                     get data
4100   IEC IN Espc,Block$
4110 '
4120 '                                     length of data block
4130   Count=LEN(Block$)
4140 '
4150 '
4160 RETURN
5000 '-----
5010 '           Extract results from binary data block
5020 '-----
5030Block_analysis:
5040 '                                     get count of block elements
5050 '
5060   Num_of_elts%=ASC(LEFT$(Dump$,1))+ASC(MID$(Dump$,2,1))*256
5070   PRINT Num_of_elts%;" block elements received"
5080 '
5090 '                                     get template word
5100 '
5110   Template%=ASC(MID$(Dump$,3,1))+ASC(MID$(Dump$,4,1))*256
5120   PRINT "Template ";Template%
5130 '
5140   Index%=5: '                                     pointer to block data
5150 '
5160 '----- single block elements
5170   FOR I=1 TO Num_of_elts%
5180 '                                     8 byte frequency
5190 '----- IEEE format
5200   IF Template% AND 1 THEN

```



```

5210         Addr=VARPTR(Freq)
5220         FOR J=0 TO 7
5230             POKE Addr+J,ASC(MID$(Dump$,Index%+J,1))
5240         NEXT J
5250         PRINT Freq,
5260         Index%=Index%+8
5270     ENDIF
5280 '----- level, detector 1
5290     IF Template% AND 2 THEN
5300         Lev%=ASC(MID$(Dump$,Index%,1))+ASC(MID$(Dump$,Index%+1,1))*256
5310         Level1=Lev%/100
5320         PRINT Level1,
5330         Index%=Index%+2
5340     ENDIF
5350 '----- level, detector 2
5360     IF Template% AND 4 THEN
5370         Lev%=ASC(MID$(Dump$,Index%,1))+ASC(MID$(Dump$,Index%+1,1))*256
5380         Level2=Lev%/100
5390         PRINT Level2,
5400         Index%=Index%+2
5410     ENDIF
5420 '----- status word
5430     State%=ASC(MID$(Dump$,Index%,1))+ASC(MID$(Dump$,Index%+1,1))*256
5440     PRINT State%,
5450     Index%=Index%+2
5460 '----- transducer
5470     IF Template% AND 64 THEN
5480         Lev%=ASC(MID$(Dump$,Index%,1))+ASC(MID$(Dump$,Index%+1,1))*256
5490         Trd=Lev%/100
5500         PRINT Trd,
5510         Index%=Index%+2
5520     ENDIF
5530 '----- limit byte
5540     IF Template% AND 128 THEN
5550         Lim%=ASC(MID$(Dump$,Index%,1))+ASC(MID$(Dump$,Index%+1,1))*256
5560         PRINT Lim%,
5570         Index%=Index%+1
5580     ENDIF
5590 '----- limit 1
5600     IF Template% AND 256 THEN
5610         Lev%=ASC(MID$(Dump$,Index%,1))+ASC(MID$(Dump$,Index%+1,1))*256
5620         Limit1=Lev%/100
5630         PRINT Limit1,
5640         Index%=Index%+2
5650     ENDIF
5660 '----- limit 2
5670     IF Template% AND 512 THEN
5680         Lev%=ASC(MID$(Dump$,Index%,1))+ASC(MID$(Dump$,Index%+1,1))*256
5690         Limit2=Lev%/100
5700         PRINT Limit2,
5710         Index%=Index%+2
5720     ENDIF
5730     PRINT
5740 NEXT I
5750 RETURN
12000 '-----
12010 '   Service Request Routine
12020 '-----

```

```

12030Srqroutine:
12040 '                               Serial Poll
12050 IEC SPL Espc,Sb%
12060 '                               check SRQ bit
12070 IF (Sb% AND 64) THEN
12080 '----- check ERD bit
12090     IF (Sb% AND 1) THEN
12100 '                               read ERD register
12110     IEC OUT Espc,"ERD?"
12120     IEC IN Espc,Erd$
12130     Erd=VAL(Erd$)
12140     PRINT "ERD:";Erd
12150 '----- check insufficient RAM bit
12160     IF (Erd AND 16) THEN
12170         PRINT "Insufficient RAM"
12180     ENDIF
12190 '----- check data ready bit
12200     IF (Erd AND 128) THEN
12210 '                               read data block
12220         GOSUB Block_query
12230         Sum=Sum+(Count-1)
12240 '                               convert binary data
12250         GOSUB Block_analysis
12260 '
12270         PRINT "-->";Sum;" bytes up to now"
12280     ENDIF
12290 ENDIF
12300 '----- check ESR Bit
12310     IF (Sb% AND 32) THEN
12320         PRINT "Operation complete"
12330 '                               clear enable register
12340         IEC OUT Espc,"*ESE 0"
12350     ENDIF
12360 ELSE
12370 '----- poll other devices
12380 ENDIF
12390 '                               enable SRQ Interrupt and return
12400 '                               in the same line to avoid nesting!
12410 '
12420 ON SRQ1 GOSUB Srqroutine: RETURN

```

3.5.13 Block-Serial Output of Scan Results in the Internal Data Format (Dump)

With this format the weighting of results is very easy as the data with increasing frequency are simply sequenced successively.

The appertaining frequency can be calculated from start frequency, stop frequency and step width by the application program if required.

The service-request routine is designed such that it weighs event-status register ERD and can thus respond to which kind of results - detector 1, detector 2 or validity byte - is ready to be fetched. This means that this routine can be applied universally as well.

In comparison to the two others, this format offers the largest advantages as to speed on the receiver side as no formatting has to be performed. Contrary to the two data formats described before, the selection of the date to be transferred is effected immediately before polling the data block. This is necessary to ensure that access to all three kinds of results is possible during the scan. The data block can be fetched immediately after the command "SCAN:BLOCK?".

```
100 '-----
110 '   Transfer of unformatted Block Data
120 '-----
130 '
140   GOSUB Prolog
150   GOSUB Init_espc
160 '
170 '                               Define settings for RF analysis
180   GOSUB Prog_scan
190 '
200   GOSUB Exec_scan
210 '
220 '
230 END
3000 '-----
3010 '   Execute Scan and wait for last block
3020 '-----
3030 Exec_scan:
3040 '                               setup block format
3050   IEC OUT Espc,"SCAN:BLOCK:FORMAT DUMP"
3060   IEC OUT Espc,"SCAN:BLOCK:COUNT 100"
3070 '                               config registers
3080   IEC OUT Espc,"*CLS;*ESE 1;*SRE 33"
3090 '                               enable all bits
3100   IEC OUT Espc,"ERDE 65535"
3110 '                               init variable
3120   Erd=0
3130 '                               waste previous results
3140   IEC OUT Espc,"SCAN:RESULTS:CLEAR"
3150 '                               terminator EOI for binary data
3160   IEC TERM 1
3170 '                               Init SRQ-Routine
3180   ON SRQ1 GOSUB Srq_routine
3190 '
3200   IEC OUT Espc,"SCAN:RUN;*OPC"
3210   PRINT "Scan is running"
3220 '
3230 '
3240   REPEAT
3250 '                               Wait for last block
```

```

3260 '                                     of scan results
3270   UNTIL Erd AND 4
3280 '
3290   PRINT "Transfer completed"
3300 '
3310 RETURN
4000 '-----
4010 '           Get data block
4020 '-----
4030Block_query:
4040 '                                     data query
4050   IEC OUT Espc,"SCAN:BLOCK?"
4060 '
4070 '                                     get data
4080   IEC IN Espc,Block$
4090 '
4100 '                                     length of data block
4110   Count=LEN(Block$)
4120 '
4130 '
4140 RETURN
12000 '-----
12010 '   Service Request Routine
12020 '-----
12030Srq_routine:
12040 '                                     serial poll
12050   IEC SPL Espc,Sb%
12060 '                                     check SRQ bit
12070   IF (Sb% AND 64) THEN
12080 '----- check ERD bit
12090     IF (Sb% AND 1) THEN
12100 '                                     read ERD register
12110       IEC OUT Espc,"ERD?"
12120       IEC IN Espc,Erd$
12130       Erd=VAL(Erd$)
12140       PRINT "ERD: ";Erd
12150 '----- check insufficient RAM bit
12160       IF (Erd AND 16) THEN
12170         PRINT "Insufficient RAM"
12180       ENDIF
12190 '----- check data ready bit detector 1
12200       IF (Erd AND 128) THEN
12210 '                                     configure for detector 1
12220         IEC OUT Espc,"SCAN:BLOCK:ELEMENT DET1"
12230         PRINT "Detector 1: ";
12240 '                                     get data block
12250         GOSUB Block_query
12260         Sum=Sum+Count/2
12270 '                                     print level values
12280         FOR I=1 TO Count/2
12290           Lev%=ASC(MID$(Block$,I*2-1,1))+ASC(MID$(Block$,I*2,1))*256
12300 '                                     1/100 dB resolution; signed
12310           Level=Lev%/100
12320           PRINT USING "-###.## ";Level;" ";
12330         NEXT
12340         PRINT
12350         PRINT "-->";Sum;" values up to now"
12360       ENDIF

```

```

12370 '----- check data ready bit detector 2
12380     IF (Erd AND 64) THEN
12390 '             configure for detector 2
12400     IEC OUT Espc,"SCAN:BLOCK:ELEMENT DET2"
12410     PRINT "Detector 2: ";
12420 '             get data block
12430     GOSUB Block_query
12440 '             print level values
12450     FOR I=1 TO Count/2
12460         Lev%=ASC(MID$(Block$,I*2-1,1))+ASC(MID$(Block$,I*2,1))*256
12470 '             1/100 dB resolution; signed
12480         Level=Lev%/100
12490         PRINT USING "-###.## ";Level;" ";
12500     NEXT
12510     PRINT
12520     ENDIF
12530 '----- check data ready bit validity
12540     IF (Erd AND 32) THEN
12550 '             configure for validity byte
12560     IEC OUT Espc,"SCAN:BLOCK:ELEMENT VALID"
12570     PRINT "Validity: ";
12580 '             get data block
12590     GOSUB Block_query
12600 '             print validity bytes
12610     FOR I=1 TO Count
12620         PRINT USING "###";(ASC(MID$(Block$,I,1))); " ";
12630     NEXT
12640     PRINT
12650     ENDIF
12660     ENDIF
12670 '----- check ESR bit
12680     IF (Sb% AND 32) THEN
12690         PRINT "Operation complete"
12700         IEC OUT Espc,"*ESE 0"
12710     ENDIF
12720 ELSE
12730 '----- poll other devices
12740 ENDIF
12750 '             enable SRQ Interrupt and return
12760 '             in the same line to avoid nesting!
12770 '
12780 ON SRQ1 GOSUB Srq_routine: RETURN

```

3.6 Error Messages and Warnings

Error Messages

Error message	Cause	Section
<i>1. LO unlock</i>	Hardware error synthesizer	4.2.3
<i>2. LO unlock</i>	Hardware error synthesizer	4.2.3
<i>Bus Control required</i>	Plotter output cannot be performed since receiver does not control IEC bus.	3.2.4.4.4
<i>CALrequired</i>	Calibration must be performed.	3.2.3.12.3
<i>Connect Plotter!</i>	Plotter output was started without a plotter being connected or the plotter address is wrong.	3.2.4.4.4 (3.2.4.4.1)
<i>Connect Printer!</i>	Printer output was started without a printer being connected.	3.2.4.4.3
<i>Ext Ref</i>	Receiver is synchronized with an external reference frequency.	3.2.4.1
<i>Frequency Sequence</i>	Increasing frequency sequence concerning entries into the table has not been adhered to.	3.2.4.2.2 3.2.4.3.2 3.2.4.3.3
<i>IEC Bus OFF(SF11)!</i>	Plotter output cannot be performed since the IEC bus is switched off. Switch it on using special function 11.	3.2.4.3.3
<i>Int Ref</i>	Receiver operates with internal reference.	3.2.4.1
<i>Limit exceeded</i>	Measured value exceeds a limit line with Spec Func 16 ON	3.2.3.12
<i>Max 2 Limits active</i>	Attempt to activate a third limit line was made.	3.2.4.3.2
<i>Max Freq 1000 MHz</i>	A frequency > 1000 MHz was entered (transducer factor, limit value).	3.2.4.2.2
<i>Max Level 200 dB</i>	With the input of a transducer factor or a limit line a value > 200 dB was entered.	3.2.4.2.2 3.2.4.3.2
<i>Max xx Values (xx = 10, 20 or 50)</i>	Maximum number of points for transducer factor or limit line is reached; no further point possible	3.2.4.2.2 3.2.4.3.2
<i>Measurement invalid Transd undefined</i>	An active transducer is not defined in the complete scan range. Invalid measured values out of the definition range.	3.2.4.3.4
<i>min Freq 9 kHz</i>	A frequency < 9 kHz was entered (transducer, limit value)	

Error message	Cause	Section
<i>Min Level-200 dB</i>	With the input of a transducer factor or a limit line a value < 200 dB was entered.	3.2.4.2.2 3.2.4.3.2
<i>Register empty</i>	A register containing no setting data is called using RCL.	3.2.4.5
<i>ERR: 2nd Mixer</i>	Hardware error during self-test	4.2.4
<i>ERR: 30 dB Range</i> <i>ERR: 60 dB Range</i>	Error during calibration	3.2.3.1213
<i>ERR: Detector Board</i>	Hardware error during self-test	4.2.4
<i>ERR: gain at 5.9 MHz</i>	Error during total calibration	3.2.3.11.3
<i>ERR: gain at xx MHz</i>	Error during total calibration	3.2.3.11.3
<i>ERR: gain at BW 10 kHz</i>	Error during total calibration	3.2.3.11.3
<i>ERR: IF Attenuator</i>	Error during total calibration	3.2.3.11.3
<i>ERR: IF Selection Board</i>	Hardware error during self-test	4.2.4
<i>ERR: Meas uncal</i>	Gain of the receiver cannot be set. Measured values are not accurate.	3.2.3.11.3
<i>ERR: Pk/MHz</i>	Error during total calibration	3.2.3.11.3
<i>ERR: QP</i>	Error during total calibration	3.2.3.11.3
<i>ERR: Synthesizer</i>	Hardware error during self-test	4.2.4
<i>ERR: Fronend</i>	Hardware error during self-test	4.2.4

Warnings	Cause	Section
<i>WARN: 30 dB Range</i> <i>WARN: 60 dB Range</i>	Warning during calibration	3.2.3.11.3
<i>WARN: Curve OFF</i>	Hint that the measurement curve is not plotted (Curve in Plotter Settings is off) in the case of plotter output during measurement (option 62).	3.2.4.4.1 3.2.4.3.3
<i>WARN:EXT REF FREQ</i>	The internal reference oscillator cannot synchronize with the connected reference (frequency not precise enough)	4.2.3
<i>WARN:EXT REF LEV</i>	Level of the external reference connected is not sufficient.	4.2.3
<i>WARN: Gain at 5.9 MHz</i>	Warning during calibration	3.2.3.11.3
<i>WARN: Gai at xx MHz/kHz</i>	Warning during calibration	3.2.3.11.3
<i>WARN: Gain at BW 10 kHz</i>	Warning during calibration	3.2.3.11.3
<i>WARN: IF Attenuator</i>	Warning during total calibration	3.2.3.11.3
<i>WARN: No Pen selcted</i>	No pen is selected for plotter output (Pen O.)	3.2.4.4.4
<i>WARN: Plotter active</i>	Plotter output is started anew using "PLOT" while the preceding plot is not yet concluded	3.2.4.4.4
<i>WARN: QP</i>	Warning during total calibration	3.2.3.11.3

4 Maintenance and Troubleshooting

4.1 Maintenance

4.1.1 Mechanical Maintenance

The ESPC requires no mechanical maintenance at all. The front panel should be cleaned from time to time preferably using a soft, damp cloth.

4.1.2 Electrical Maintenance

4.1.2.1 Testing the Level Measuring Accuracy

As it is possible to perform a total calibration with the help of the built-in calibration generators, a high long-term stability of the level measurement characteristics, which exclusively depends on the aging of the calibration generators, is ensured. The measurement accuracy should be checked once every year according to section 5.2.6.1.1. The re-adjustments of the calibration generators required following exceedings of the tolerance limits should be effected by an R&S-service station.

4.1.2.2 Testing and Adjustment of the Frequency Accuracy

The frequency accuracy of the reference oscillator should be checked once a year according to section 5.2.1. Re-adjustment, if required, may be performed only after at least 30 minutes of warming-up.

Remove the instrument cover (cf. section 4.3)

Connect the frequency counter (error $< 1 \times 10^{-8}$) to the socket X165 (fig. 4-1).

Switch off the reference input in the setup menu (cf. section 3.2.6.4)

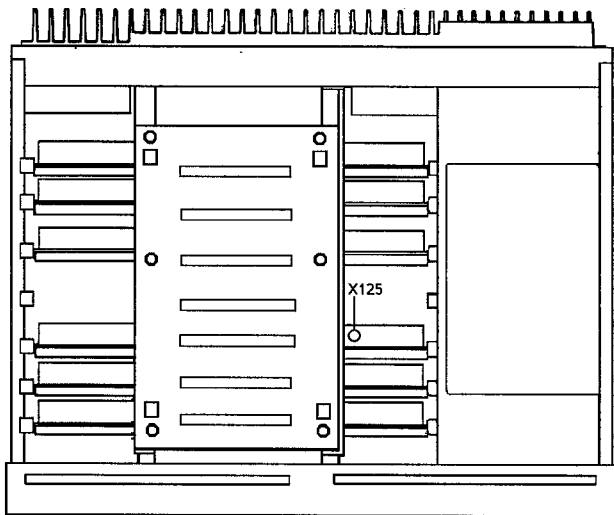

Fig. 4-1 Location of the socket X165 (instrument seen from below)

Adjust the frequency accuracy to 64 MHz \pm 10 Hz using the potentiometer REF FREQ, R323 (fig. 4-2) .

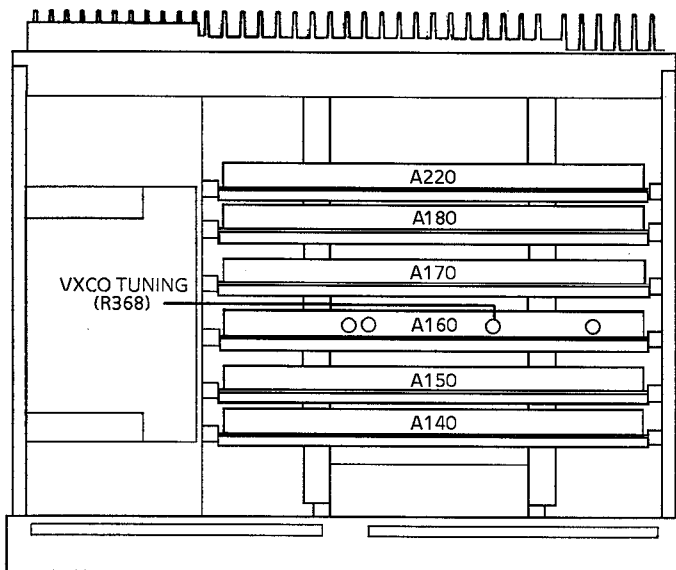

Fig. 4-2 Location of the potentiometer VREF FREQ, R323 (instrument seen from above)

4.1.3 Replacing the Battery

The instrument contains a lithium battery for buffering the static RAM. The durability at normal ambient temperatures is 5 years. A discharged battery leads to the loss of data stored in the CMOS RAM when the instrument is switched off. This back-up battery is located on the module A220 (CPU-BOARD). It can be replaced in the following way:

Withdraw the instrument cover.

Remove the CPU-board (cf. section 4.3).

Unsolder the discharged battery.

The following types of batteries can be used instead:

- SAFT LS14250 CNA (R&S order no. 565.1687)
- Sonnenschein SL-750/P (R&S order no. 565.1687)

When fitting the new battery by way of soldering, make sure that the polarity is correct (cf. fig. 4-3).

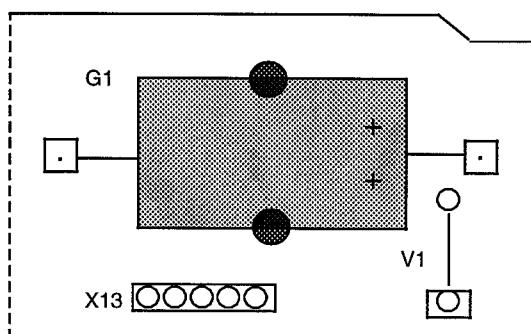

Fig. 4-3 Mounting position of the battery

4.2 Function Check and Self-Test

The ESPC features extensive equipment for checks and self-test, which allow comprehensive control of the receiver functions. If there is a fault, the device itself is able to locate the defect module. Exactly defined module interfaces make it possible to replace the modules without individual adjustment (cf. section 4.3). The adjustment to the total receiver, which may be required subsequently, is performed by menu-control and using the internal calibration generator so that no additional measuring instruments and devices are necessary.

The receiver functions are checked at four levels:

- Automatic test of the processor functions and adjustment of the A/D-converter following switch-on of the instrument.
- Test of all processor functions with cold start of the instrument.
- Permanent check of the synthesizer and power supply during operation.
- Function check of the total receiver (processor, synthesizer, signal unit) by manually calling the self-test.

4.2.1 Switch-on Test

When switching on the instrument the self-test of the processor functions first runs. Subsequently a rough function test of the CMOS RAM is subsequently performed by polling the contents of a memory location. The following initialization of the analog modules serves to check the correct functioning of the interface module for the serial module control. Function test and self-adjustment of the A/D-converter terminate the switch-on test of the ESPC.

4.2.2 Cold Start

An extended test of the CPU board is carried out with the so-called cold start of the receiver. It is triggered by pressing the "." key in the numeric keypad during switch-on of the ESPC.

Compared to the usual test (see above) the program memory (EPROM), the static (CMOS RAM) and the volatile data memory (DRAM), the IEC-bus as well as the interfaces of the remaining modules are tested additionally in the case of the cold start following switch-on. Upon the detection of an error the message *ERR: CPU* is output on the frequency display. The receiver can no longer be operated.

Since not every device function makes use of all function units of the processor module, it may be possible that the receiver can be further operated. In this case a detailed hint as to the defect function unit can be obtained by calling the self-test after having switched off and on again the ESPC.

Caution: *With the cold start all the data stored internally, such as limit lines and transducer factors are deleted and all the settings are brought to their default status.*

4.2.3 Checking the Synthesizer and the Power Supply

During operation all synthesizer loops in the instrument are checked as to whether the tuning voltages of the oscillators are within the permissible range. The following error messages may occur:

- 1. *LO UHF unlock*
- 2. *LO UHF unlock*

A hint as to the faulty module can be obtained by calling the self-test. If the level applied to the socket EXT REF INPUT is too small, the message *WARN:EXT REF LEV* is read out on the DATA INPUT display.

If the reference signal has a frequency that is not suitable for the ESPC, the message *WARN:EXT REF FREQ* is indicated on the DATA INPUT display.

The internal supply voltages are checked both following switch-on of the instrument and permanently during the operation independently of the controller. The flashing of the green LED SUPPLY OK on the rear panel signals the correct functioning of the power supply. The instrument is switched off within 3 s when a supply voltage deviates from its nominal value as well as when there is a short-circuit in the instrument or in one of the accessories supplied by the ESPC. In connection with a short-circuit current limiting device operating without delay, grave sequence errors are prevented. Due to the processor-independent operation this protective functions are still effective even when the CPU-board fails.

4.2.4 Self-Test

The self-test allows to check the functions of the instrument without using additional measuring instruments (cf. section 3.2.4.2.3). If there is an error in the instrument, the module causing the error is indicated in the DATA INPUT display. The error is located by means of the following measures:

- The A/D-converter on the processor module has an additional test input in order to measure voltages within the modules.
- During the self-test the important d.c. voltages, such as module-internal supply voltages or amplifier operating points, are measured and compared to their nominal values on every module.
- Level detectors check the oscillator levels required for operation of the mixer.
- The calibration generators produce a signal with an exactly known level at the RF-input of the instrument. The processing of the input signal in the individual RF-and IF-stages of the receiver can be followed and faulty stages, e.g. amplifiers the gain of which deviates from the nominal value can be detected with the help of level detectors in the signal path. The detectors are available on every RF- and IF-module.

To avoid error messages that are not true, it must be checked whether all the functions of a lower function level operate correctly prior to checking a higher function level. It is thus only possible to recognize one error. The sequence in which the tests are performed results from the hierarchy of the functions in the instrument. The self-test is triggered by calling the function START TEST (cf. section 3) in the self-test menu. The hint *SELFTEST RUNNING* appears on the DATA INPUT display.

a) Testing the Processor Function

After having started the self-test or a cold start (cf. section 4.2.2) the processor functions and the internal supply voltages are first checked. If there is an error in one of the following function blocks on the CPU-board:

- MAIN CPU (processor),
- OT PROM (memory for operating system),
- FLASH EPROM (firmware program memory),
- IFPAS CONTROLLER (serial interface for control of the modules) or
- CMOS RAM (non-volatile data memory),

the instrument may not be able to output a detailed error message; the first and the third line of the DATA INPUT display appear in inverse screen: the instrument can no longer be operated.

An error occurring in one of the function blocks

- DRAM (volatile data memory),
- MUART (multi-function component),
- INTERRUPT CONTROLLER or
- A/D-converter

leads to the output of the message *ERR: CPU BOARD*; in addition the instrument can no longer be operated in order to prevent faulty measurements.

A faulty function in one of the blocks

- REAL TIME CLOCK (clock component),
- IEC BUS CONTROLLER (IEC-BUS interface),
- RS232 CONTROLLER (serial interface for loading a new firmware)

is indicated by the error messages

- *ERROR:Time Clock*,
- *ERROR:IEC* or
- *ERROR:RS232* during the self-test.

The error message remains visible until it is deleted by calling a menu. Since not every instrument function makes use of all function units, operation with reduced characteristics may be possible. To give a hint as to the defect module the message *ERR:CPU BOARD* appears. If there is no error, it is indicated by *CPU BOARD ok*.

b) Supply Voltage Test

First the device-internal supply voltages +5 V, +10 V, -10 V and +28 V are checked. The following messages are output on the DATA INPUT display, if the deviations exceed the permissible range:

- *ERR: +5 V*,
- *ERR:+10 V*,
- *ERR:-10 V* or
- *ERR:+28 V*;

the self-test is aborted and the message "*Test aborted*" appears.

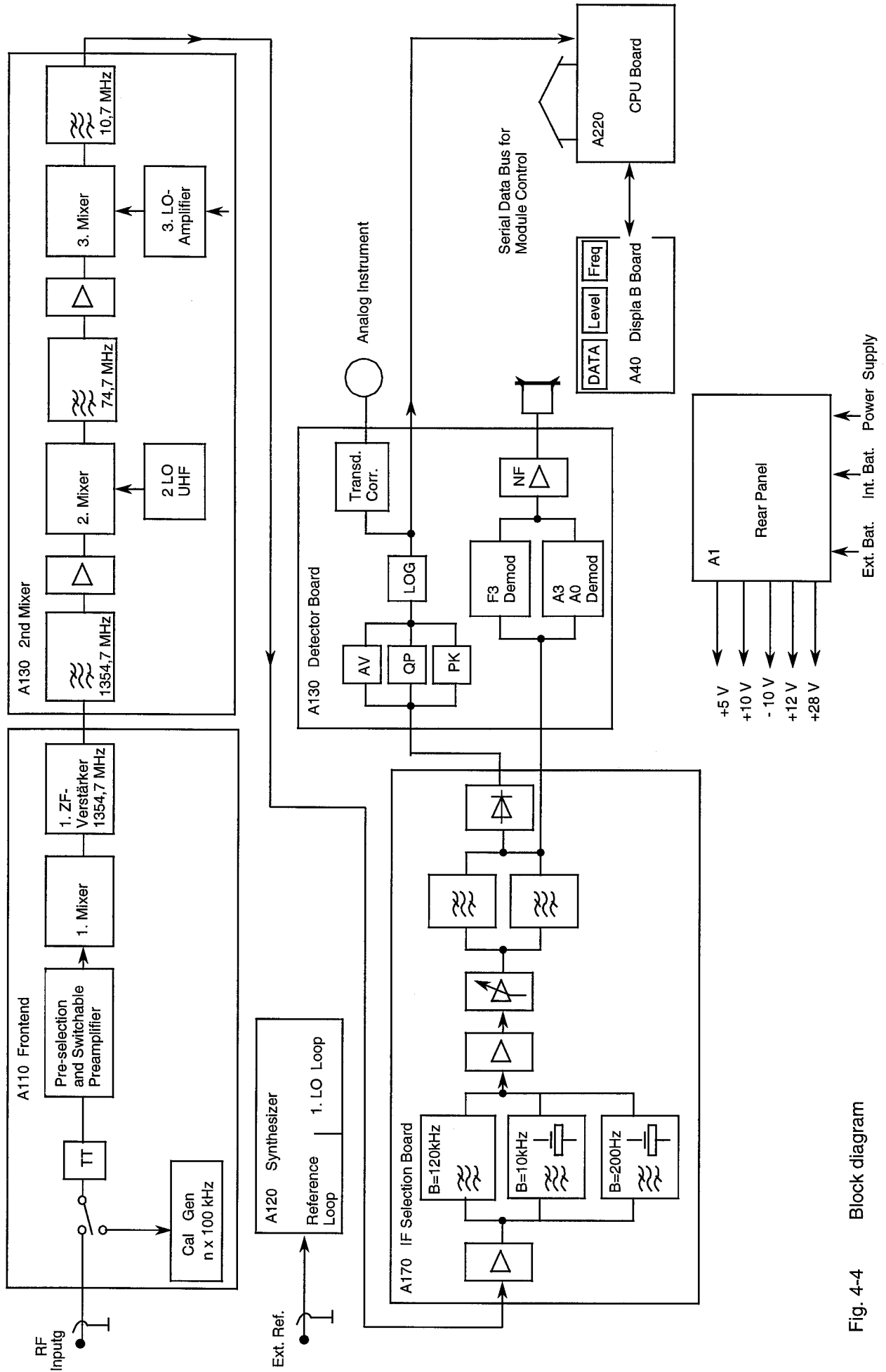

Fig. 4-4 Block diagram

c) Synthesizer Test

Correct operation of the oscillators is required for testing the signal path. For this reason the synthesizer is checked first. The module A120 (SYNTHESIZER) contains the VCO for controlling the first mixer, the step recovery diode multiplier circuit, the sampling mixer, a digital and analog control loop.

The module tests comprise the test of the control loops at various synthesizer divider factors, checking the operating points of oscillator and amplifier as well as the internal signal levels. An error is indicated by *ERR:Synth*; the self-test is aborted and the hint "*Test aborted*" appears.

Subsequently the second conversion oscillator, which is contained on the module A 130 (2ND MIXER), and the associated control loop are checked. The message *ERR:2nd Mixer, Test aborted* is indicated on the DATA INPUT display, when there are deviations from the nominal frequency or when the oscillator level falls below that required for operation of the 2nd mixer.

After the successful completion of all synthesizer tests, "*Synth Boards ok*" appears on the DATA INPUT display.

d) Testing the Signal Path

Subsequently all the RF-, IF- and weighting modules contained in the receiver are checked. Figure 4-4 provides an overview on the signal flow:

Two calibration generators providing the test signals for checking the signal-processing stages are located on the module A110 (Frontend). The signal flow via the attenuator, preselection filters, preamplifier, 1st mixer and 1st 1354.7-MHz IF amplifier is checked by means of a level detector; furthermore module-internal supply voltages, the operating points of the preamplifier and of the 1st IF amplifier and the tuning voltage of the variable preselection filters are checked. Any errors detected are read out on the DATA INPUT display with the message "*ERR:FRONTEND*", "*Test aborted*".

To begin with, the d.c. operating points of the 2nd 1354.7-MHz IF amplifier and of the 74.7-MHz IF amplifier are checked on the module A130 (2ND MIXER); the control loop and the output level of the 2nd conversion oscillator (2nd LO LOOP) are subsequently tested. In addition the output level of the LO amplifier for control of the 3rd mixer and the level control of the 64-MHz calibration generator are checked. In the case of an error the message "*ERR:2ND MIXER*", "*Test aborted*" is output.

The self-test of the module A170 (IF SELECTION BOARD) starts with the examination of the operating points of the 10.7-MHz IF amplifier. The signal level applied to the module input is scanned by a level detector. The signal flow via the IF amplifiers and main selection filters is tested by measuring the d.c. levels applied to the demodulator output. In addition the IF gain correction that can be set digitally is tested. In the case of an error the message "*ERR:IF SELECTION BD*", "*Test aborted*" is indicated on the DATA INPUT display.

The module A180 (DETECTOR BOARD) is eventually tested. After having tested the module-internal supply voltages a level detector checks the 10.7-MHz input level of the listener path. The average value (AV) detector, peak value detector (PK) and the quasipeak detector (QP) are subsequently examined. After that the logarithmic amplifier is tested. Finally the control circuit for the analog instrument and the transducer correction are tested. If there is a faulty function, the message "*ERR:DETECTOR BOARD*", "*Test aborted*" is indicated on the DATA INPUT display.

The correct termination of the self-test is indicated by the message "*SELFTEST COMPLETE*", "*Instrument o. k.*". The ESPC then returns to its normal operating condition. The entire self-test completed with "*Instrument ok*" takes about 120 seconds.

4.3 Hints for Loading the Instrument Firmware

4.3.1 Introduction

The instrument firmware for test receivers ESHS, ESVS and ESVD is stored in non-volatile FLASH memories, which can be erased and reprogrammed inside the instrument. To carry out a firmware update, it is thus no longer necessary to open the instrument in order to exchange the components. Loading is effected by means of the "FLASHUP.EXE" program from a personal computer (AT) via the serial RS232 interface.

4.3.2 Hardware Requirements

Firmware loading program FLASHUP.EXE can be executed on any personal computer conforming to industrial standard. The hardware must comprise a floppy disk drive (3 $\frac{1}{2}$ " or 5 $\frac{1}{4}$ ") as well as an RS232 interface. The use of a hard disk is recommended. No demands are made on the screen.

Each serial standard interface cable comprising a 25-pin male and a 9-pin female connector can be used to connect the test receiver to the PC, a complete wiring (cf. Fig. 4-10) being mandatory. Rohde & Schwarz offer a corresponding cable under order no. 816.1096.00 (included in service kit EZ-8)

4.3.3 Files for FLASHUP

The program package for transferring the firmware consists of the following files:

<i>FLASHUP.EXE</i>	main program
<i>FLASHUPD.MSG</i>	help texts (German)
<i>FLASHUPD.NDX</i>	index for German help texts
<i>FLASHUPE.MSG</i>	help texts (English)
<i>FLASHUPE.NDX</i>	index for English help texts

There are separate files for the different test receiver series ESXS10, ESXS30 and ESS in which the instrument firmware to be loaded is stored:

<i>ESXS10.Hxx</i>	for test receivers ESHS10 / ESVS10 / ESVD
<i>ESXS30.Hxx</i>	for ESHS / ESVS models 20 and 30
<i>ESS.Hxx</i>	for ESS

"xx" denotes a 2-digit number which is different for each firmware version.

A disk contains one of those files together with the FLASHUP program package and the release notes in which the changes and extensions of the respective firmware version are listed in brief.

4.3.4 Installation

a) Loading from the Floppy Disk Drive

Insert floppy disk into drive A: or B: and call the program:

```
C:\>a:flashup
```

b) Loading from the Hard Disk

Copy firmware loading program FLASHUP.EXE to a hard disk:
Making a separate subdirectory is recommended.

Insert the floppy disk containing the FLASHUP.EXE file or B: and start copying.

```
Example: C:\>md flash  
           C:\>cd flash  
           C:\FLASH>copy a:*. * c:
```

A higher processing rate is achieved additionally if the firmware to be loaded (i.e. the ESXS10.Hxx or ESXS30.Hxx file) is also copied to the hard disk.

4.3.5 Starting the Firmware Loading Procedure

Using this alternative, the execution time for the loading procedure of the instrument firmware can be shortened substantially. First the complete contents of the floppy disk has to be copied to the hard disk. Making a separate subdirectory on the hard disk is recommended

Connect the PC to the test receiver by means of a cable.

Switch off test receiver.

Call *FLASHUP* program.

Move the cursor between the different menu items by means of or keys.

Press ENTER key.
A pull down window is displayed.

Select the menu items using or keys.

Press ENTER key.
The function selected is executed or a parameter set.

The menu bar is reached or a current process aborted using the ESC key.

Help texts: A brief explanation about the contents of each function is given in the bottom line of the screen. Detailed help texts are available using the function key [F1]. The window opened can be closed again using the ESC key.

Error messages: The FLASHUP program supervises the firmware loading process which is protected by a defined protocol and by a check sum procedure. Whenever an error occurs during the transfer, the user is informed about the problem in a special window. As far as possible, the program gives hints on how to solve the problem.

Initialization:

Select the firmware file to be loaded using menu item *File Select HEX-File* .

Press ENTER.

The name of the file which was loaded last (if there is any) is displayed. If no file has been loaded, a selection list can be set up by simultaneously pressing the CTRL (or Strg) and ENTER keys. The drive can be changed by pressing the [F3] function key. This is necessary if the firmware is to be loaded from the floppy disk.

Select the file using the cursor keys and confirm using ENTER.

Select the serial interface at the PC to which the cable is connected (COM1 to COM4) and set the baud rate. The other RS232 parameters (word length, start/stop bit, etc.) are fixedly set.

The language for outputting help texts and error messages can be chosen between German and English.

The extensions and changes the firmware version contains are displayed under menu item *Info - Release Notes* (German or English).

Note: *All program parameters (set baud rate, HEX-file loaded, etc.) are saved in the FLASHUP.INI file and stored anew when exiting the program using QUIT.*

Starting the loading procedure:

Select menu item *Execute* using the cursor keys.

The firmware loading procedure is started by pressing the ENTER key twice.

Switch on test receiver.

The loading procedure runs automatically, the run is displayed by a bar display on the PC screen. The program signals the end of the transfer, the receiver automatically starts in its normal operating mode. The loading procedure can be aborted using the ESC key.

Note: *When aborting the loading procedure, the test receiver has no valid firmware. Thus it is inoperative. In order to load the firmware anew, menu item *Execute* has to be selected and the receiver to be switched off and on again.*

Exiting the program:

Exit firmware loading program FLASHUP by selecting menu item *QUIT* and pressing the ENTER keys.

25-pin D-shell (male)
(Test Receiver)

25pin D-shell (male)
(PC)

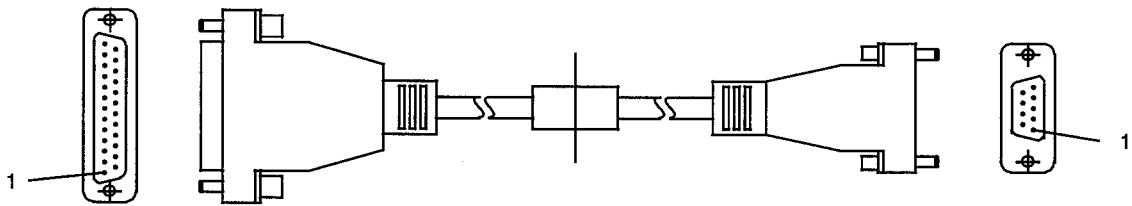
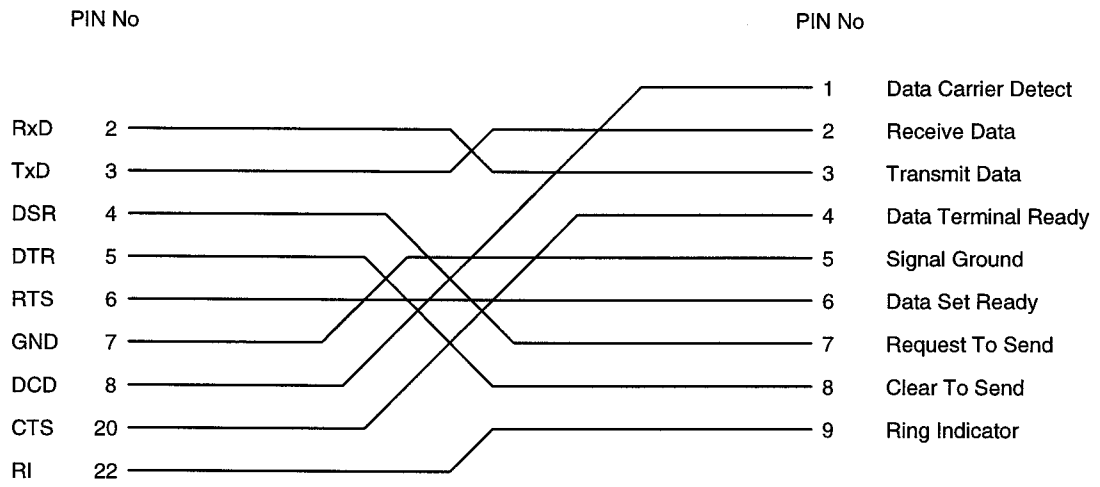

Fig. 4-8 Adapter cable for serial interface

4.4 Hints for Loading the Instrument Firmware

4.4.1 Introduction

The instrument firmware for test receivers ESHS, ESVS and ESVD is stored in non-volatile FLASH memories, which can be erased and reprogrammed inside the instrument. To carry out a firmware update, it is thus no longer necessary to open the instrument in order to exchange the components. Loading is effected by means of the "FLASHUP.EXE" program from a personal computer (AT) via the serial RS232 interface.

4.4.2 Hardware Requirements

Firmware loading program FLASHUP.EXE can be executed on any personal computer conforming to industrial standard. The hardware must comprise a floppy disk drive (3¹/₂" or 5¹/₄"") as well as an RS232 interface. The use of a hard disk is recommended. No demands are made on the screen.

Each serial standard interface cable comprising a 25-pin male and a 9-pin female connector can be used to connect the test receiver to the PC, a complete wiring (cf. Fig. 4-10) being mandatory. Rohde & Schwarz offer a corresponding cable under order no. 816.1096.00 (included in service kit EZ-8)

4.4.3 Files for FLASHUP

The program package for transferring the firmware consists of the following files:

<i>FLASHUP.EXE</i>	main program
<i>FLASHUPD.MSG</i>	help texts (German)
<i>FLASHUPD.NDX</i>	index for German help texts
<i>FLASHUPE.MSG</i>	help texts (English)
<i>FLASHUPE.NDX</i>	index for English help texts

There are separate files for the different test receiver series ESXS10, ESXS30 and ESS in which the instrument firmware to be loaded is stored:

<i>ESXS10.Hxx</i>	for test receivers ESHS10 / ESVS10 / ESVD
<i>ESXS30.Hxx</i>	for ESHS / ESVS models 20 and 30
<i>ESS.Hxx</i>	for ESS

"xx" denotes a 2-digit number which is different for each firmware version.

A disk contains one of those files together with the FLASHUP program package and the release notes in which the changes and extensions of the respective firmware version are listed in brief.

4.4.4 Installation

a) Loading from the Floppy Disk Drive

- ▶ Insert floppy disk into drive A: or B: and call the program:

```
C:\>a:flashup
```

b) Loading from the Hard Disk

- ▶ Copy firmware loading program FLASHUP.EXE to a hard disk: Making a separate subdirectory is recommended.
- ▶ Insert the floppy disk containing the FLASHUP.EXE file or B: and start copying.

```
Example: C:\>md flash  
C:\>cd flash  
C:\FLASH>copy a:*. * c:
```

A higher processing rate is achieved additionally if the firmware to be loaded (i.e. the ESXS10.Hxx or ESXS30.Hxx file) is also copied to the hard disk.

4.4.5 Starting the Firmware Loading Procedure

Using this alternative, the execution time for the loading procedure of the instrument firmware can be shortened substantially. First the complete contents of the floppy disk has to be copied to the hard disk. Making a separate subdirectory on the hard disk is recommended

- ▶ Connect the PC to the test receiver by means of a cable.
- ▶ Switch off test receiver.
- ▶ Call *FLASHUP* program.
- ▶ Move the cursor between the different menu items by means of ← or → keys.
- ▶ Press ENTER key.
A pull down window is displayed.
- ▶ Select the menu items using ↑ or ↓ keys.
- ▶ Press ENTER key.
The function selected is executed or a parameter set.

The menu bar is reached or a current process aborted using the ESC key.

Help texts: A brief explanation about the contents of each function is given in the bottom line of the screen. Detailed help texts are available using the function key [F1]. The window opened can be closed again using the ESC key.

Error messages: The FLASHUP program supervises the firmware loading process which is protected by a defined protocol and by a check sum procedure. Whenever an error occurs during the transfer, the user is informed about the problem in a special window. As far as possible, the program gives hints on how to solve the problem.

Initialization:

- ▶ Select the firmware file to be loaded using menu item *File Select HEX-File*.
- ▶ Press ENTER.
The name of the file which was loaded last (if there is any) is displayed. If no file has been loaded, a selection list can be set up by simultaneously pressing the CTRL (or Strg) and ENTER keys. The drive can be changed by pressing the [F3] function key. This is necessary if the firmware is to be loaded from the floppy disk.
- ▶ Select the file using the cursor keys and confirm using ENTER.
- ▶ Select the serial interface at the PC to which the cable is connected (COM1 to COM4) and set the baud rate. The other RS232 parameters (word length, start/stop bit, etc.) are fixedly set.

The language for outputting help texts and error messages can be chosen between German and English.

The extensions and changes the firmware version contains are displayed under menu item *Info - Release Notes* (German or English).

Note: *All program parameters (set baud rate, HEX-file loaded, etc.) are saved in the FLASHUP.INI file and stored anew when exiting the program using QUIT.*

- ▶ Starting the loading procedure:
 - ▶ Select menu item *Execute* using the cursor keys.
 - ▶ The firmware loading procedure is started by pressing the ENTER key twice.
- ▶ Switch on test receiver.
The loading procedure runs automatically, the run is displayed by a bar display on the PC screen. The program signals the end of the transfer, the receiver automatically starts in its normal operating mode. The loading procedure can be aborted using the ESC key.

Note: *When aborting the loading procedure, the test receiver has no valid firmware. Thus it is inoperative. In order to load the firmware anew, menu item *Execute* has to be selected and the receiver to be switched off and on again.*

Exiting the program:

Exit firmware loading program FLASHUP by selecting menu item *QUIT* and pressing the ENTER keys.

25-pin D-shell (male)
(Test Receiver)

25pin D-shell (male)
(PC)

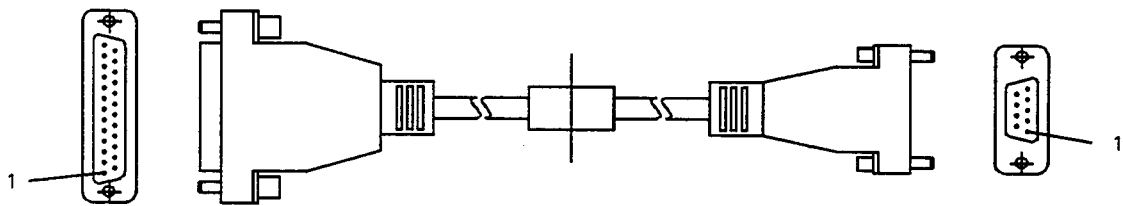
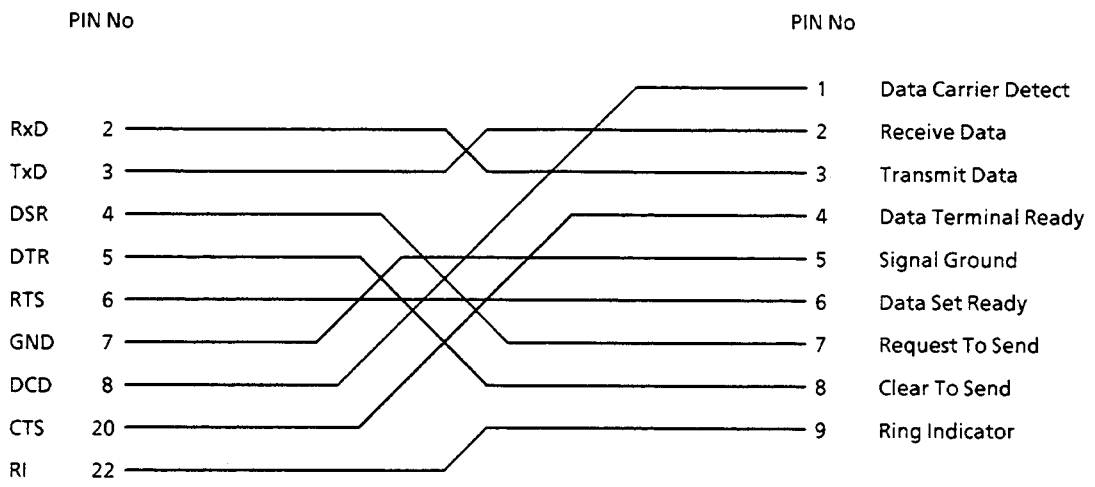

Fig. 4-8 Adapter cable for serial interface

5 Testing the Rated Specifications

5.1 Test Instruments and Utilities

Item No.	Type of instrument, data	Type	Order No.	Application Section
1	Frequency counter up to 100 MHz Error < 1×10^{-8} , resolution 0.1 Hz			5.2.1
2	Digital multimeter, 41/2 digits	UDS5	349.1510.02	5.2.7.3 5.2.8.2 5.2.8.3 5.2.8.4
3	Signal generator 9 kHz...2500 MHz Level: -130...13 dBm	SMHU	348.0010.02	5.2.2.4.1 5.2.2.4.2
4	Signal generator 9 kHz...3710 MHz Level: -130...13 dBm	SMHU	348.0010.03	5.2.2.3.1 / 2 / 3 5.2.2.4.1 5.2.3 5.2.6.1.1 / 2 5.2.7 5.2.8.1
5	6-dB coupler, 9 kHz...2500 MHz			5.2.2.4.1
6	Reflection meter, 9 kHz...2500 MHz			5.2.2.1
7	50- Ω termination, 9 kHz..2500 MHz		272.4510.50	5.2.4 5.2.5
8	Spectrum analyzer, 9 kHz..3709.4 MHz Sensitivity: -127 dBm	FSEB	1066.3010.30	5.2.2.2
9	Power meter 9 kHz...2050 MHz, Z= 50 Ω -30...10 dBm, error < 0.1 dB	NRV	828.2511.02	5.2.6 5.2.8.1 5.2.8.5
10	Pulse generator, Schwarzbeck, 3 standards Pulse gen. IGUS, calibrated to < 0.1 dB	IGUS 2915		5.2.6.1.1 c
11	Attenuator, 9 kHz... 2500 MHz attenuation error < 0.1 dB	RSP	831.3515.02	5.2.6.1.2 5.2.6.1.3
12	RF millivoltmeter	URE 2	350.5315.02	5.2.7.2
13	Oscilloscope, f_{\max} = 10 MHz			5.2.7.1
14	Power supply 0...35 V, 5 A	NGB 70	177.7227.90	5.2.8.2/3

5.2 Test Sequence

The rated specifications of the receiver are checked after a warm-up time of at least 30 minutes and a total calibration. It is thus ensured, that the specified data are adhered to.

The values given in the following sections are not guaranteed, only the Technical Data given in the Data Sheet are binding.

Note: The digital level values are output via IEC-bus at a resolution of 0.01 dB, thus increasing the read-off accuracy for the measurement values.

5.2.1 Frequency Accuracy

Test instrument: Frequency counter, 10 MHz, error $<1 \times 10^{-8}$

Test setup: Connect frequency counter to the 10.7-MHz output on the rear panel.
Settings on the ESPC:
Select selftest function 02 (IF Gain Adjust).

Measurement: Measure frequency using frequency counter.
Rated frequency..... 10.7 MHz ± 32 Hz

5.2.2 RF Input

5.2.2.1 Input VSWR

Test instrument: Network analyzer (9 kHz to 2500 MHz)

Test setup: Connect network analyzer to the RF input of the ESPC via a low-reflection cable.

Measurement: Measure the return loss of the ESPC with the following settings:

RF attenuation	Rated return loss	
	9 kHz to 1000 MHz	1000 to 2500 MHz
0 dB	9.5 dB	9.5 dB
10 dB	15.6 dB	11.7 dB

Note: A return loss of 9.5 dB corresponds to a VSWR of 2,
a return loss of 11.7dB corresponds to a VSWR of 1,7
a return loss of 15.6 dB corresponds to a VSWR of 1.4

5.2.2.2 Oscillator Reradiation

Test instrument Spectrum analyzer (74.7 MHz to 3709.4 MHz)

Test setup: Connect spectrum analyzer to the RF input of the ESPC.
 Setting on the receiver:
 RF ATT 0 dB

Analyzer setting:
 Display in dB μ V
 Reference level 60 dB μ V
 Scale 10 dB/DIV
 Bandwidth 1 kHz
 Mode Max Hold
 Set start and stop frequency of the analyzer depending on the receiver frequency according to the following table:

ESPC frequency range	Start frequency	Stop frequency
9 kHz to 1000 MHz	1354.709 MHz	2354.7 MHz
1000 to 1900 MHz	1394.7 MHz	2294.7 MHz
1900 to 2500 MHz	1503.7 MHz	2105.3 MHz

Measurement: Slowly step through the receiver frequency in the range <25 MHz in steps of 5 MHz, in the range \geq 25 MHz in steps of 25 MHz and in the range \geq 1000 MHz in steps of 100 MHz, such that the level is indicated on the analyzer with each frequency. Search for the maximum value using the marker.

5.2.2.3 Interference Rejection

Test instrument: Signal generator (74.7 MHz to 2400 MHz)

Note: *In order not to measure the sideband noise of the transmitter, the signal-to-noise ratio of the transmitter should exceed 140 Bc/Hz. This may be obtained by connecting a highpass filter into the signal path between generator output and receiver input, if required.*

Test setup: Connect a signal generator to the RF input of the ESPC.
 Level 100 dB μ V

ESPC settings:
 RF ATT 0 dB
 Mode Low Noise
 Detector AV
 OP Range 60 dB

5.2.2.3.1 Image Frequency of the 1st IF

Setting: Set generator frequency and IF bandwidth of the ESPC according to the table below:

ESPC frequency f_E	Generator frequency
9 kHz to 1000 MHz	$f_E + 2709.4$ MHz
1000 to 1900 MHz	$f_E + 789.4$ MHz
1900 to 2500 MHz	$f_E - 789.4$ MHz

- Measurement:
- Measure level P_{ind} on the receiver frequency f_E .
 - The image frequency rejection is obtained from: $100 - P_{ind}/dB\mu V$
 - Level display on the receiver according to the table below:

Frequency range	Level displayed on the receiver
9 kHz to 1000 MHz	≤ 30 dB μV
1000 to 1900 MHz	≤ 50 dB μV
1900 to 2500 MHz	≤ 60 dB μV

5.2.2.3.2 Image Frequency of the 2nd IF

Setting: Set generator frequency and ESPC frequency according to the table below:

Frequency f_E	Generator frequency
100 MHz	249.4 MHz
2490 MHz*)	2340.6 MHz

Measurement: Measure level with f_E (P_{ind}).
 The image frequency rejection is obtained from: $100 - P_{ind}/dB\mu V$
 Displayed level on the receiver
 100 and 2490 MHz < 30 dB μV

5.2.2.3.3 IF Rejection

Setting: Set generator frequency and IF bandwidth of the ESPC in the three receiver ranges according to the table below:

Frequency f_E	Generator frequency	IF bandwidth
9 kHz to 1000 MHz	1354.7 MHz	10 kHz
1000 to 2500 MHz	394.7 MHz	10 kHz

Measurement: Measure level P_{ind} on the respective receive frequency.
 The IF rejection is obtained as follows: $100 - P_{ind}/dB\mu V$
 Level displayed on the receiver < 10 dB μV

5.2.2.4 Nonlinearities

5.2.2.4.1 3rd-Order Intercept

Test instrument: 2 signal generators, 6-dB coupler.
 Test setup: Connect signal generator to the RF input of the ESPC via the 6-dB coupler.
 Level on the ESPC 97 dB μV with f_{S1} and f_{S2} , each
 Settings on the ESPC:
 RF attenuation 0 dB
 Mode Low Noise
 Detector AV
 Op. Range 60 dB
 IF-Bandwidth 120 kHz

Measurement: Set receiver frequency and generator frequencies according to the subsequent table and measure level on the respective frequencies:

The intercept IP3 is calculated using the following formula:

$$IP3/dBm = (97 \text{ dB}\mu\text{V} - (\text{level with } f_E)/\text{dB}\mu\text{V})/2 - 10 \text{ dBm}$$

Abbreviations: f_{S1} : generator frequency 1
 f_{S2} : generator frequency 2
 f_E : receiver frequency

f_{S1}	f_{S2}	f_E
5 MHz	6 MHz	4 MHz
5 MHz	6 MHz	7 MHz
14.0 MHz	15 MHz	13 MHz
14 MHz	15 MHz	16 MHz
35 MHz	45 MHz	25 MHz
35 MHz	45 MHz	55 MHz
140 MHz	150 MHz	130 MHz
140 MHz	150 MHz	160 MHz
285 MHz	295 MHz	275 MHz
285 MHz	295 MHz	305 MHz
475 MHz	485 MHz	465 MHz
475 MHz	485 MHz	495 MHz
600 MHz	610 MHz	590 MHz
600 MHz	610 MHz	620 MHz
730 MHz	740 MHz	720 MHz
730 MHz	740 MHz	750 MHz
980 MHz	990 MHz	970 MHz
980 MHz	990 MHz	1000 MHz
1120 MHz	1130 MHz	1110 MHz
1120 MHz	1130 MHz	1140 MHz
1500 MHz	1510 MHz	1490 MHz
1500 MHz	1510 MHz	1520 MHz
1870 MHz	1880 MHz	1870 MHz
1870 MHz	1880 MHz	1890 MHz
2030 MHz	2040 MHz	2020 MHz
2030 MHz	2040 MHz	2050 MHz
2470 MHz	2480 MHz	2460 MHz
2470 MHz	2480 MHz	2490 MHz

5.2.2.4.2 2nd-Order Intercept

Test instrument: Signal generator 100 kHz to 1250 MHz
Switchable lowpass filter

Test setup: Connect signal generator to the RF input of the ESPC via the lowpass which is appropriate for the respective receiver frequency (cf. table).
Level on the ESPC 97 dB μ V if f_{S1}

Settings on the ESPC:

RF attenuation 0 dB
 Mode Low Noise
 Detector AV
 Op Range 60 dB
 IF bandwidth 10 kHz

Measurement: Set receiver frequency and generator frequency according to the table below and measure level on the respective frequencies.
 The intercept IP2 is calculated using the following formula:
 $IP2/dBm = (97 \text{ dB}\mu V - (\text{Level with } f_E)/dB\mu V) - 10 \text{ dBm}$

Abbreviations: f_{S1} : generator frequency 1
 f_E : receiver frequency
 f_{TP} : Limit frequency of lowpass

f_{S1}	f_{TP}	f_E
160 kHz	250 kHz	320 kHz
4 MHz	5 MHz	8 MHz
12 MHz	15 MHz	24 MHz
40 MHz	50 MHz	80 MHz
85 MHz	100 MHz	170 MHz
195 MHz	250 MHz	390 MHz
495 MHz	500 MHz	990 MHz
950 MHz	1000 MHz	1900 MHz
1250 MHz	1500 MHz	2500 MHz

5.2.3 IF Bandwidths

Test instrument: Signal generator

Test setup: Connect signal generator to the RF input of the ESPC.

Level 90 dB μ V
 Frequency 100 MHz
 Settings on the ESPC:
 Frequency 100 MHz
 RF ATT Auto
 Mode Low Noise
 Detector AV
 OP Range 60 dB

Measurement: Set the frequency of the receiver such that the level display indicates maximum. Measure the 6-dB and 60-dB bandwidths by means of rotating the receiver frequency upward and downward according to the table below.

nominal bandwidth	6-dB bandwidth	shape factor (typ. value) B_{6dB}/B_{60dB}
200 Hz	170 ...220 Hz	1:7.5
10 kHz	9.5 kHz \pm 0.5 kHz	1:4
120 kHz	120 kHz \pm 10 %	1:5

5.2.4 Noise Indication

Test instrument: 50-Ω termination

Test setup: Terminate RF input of the ESPC with 50 Ω.

Settings on the ESPC:

RF ATT 0 dB
 Mode Low Distortion
 OP Range 60 dB
 Meas Time 100 ms
 Detector AV

Measurement: Check the noise indication according to the table below:

Frequency range	IF BW	Noise indication
9 to 150kHz	200 Hz	< 30 to < 15 dBμV
150 kHz to 5 MHz	10 kHz	< 35 to < -5 dBμV
5 to 30 MHz	10 kHz	< -5 dBμV
30 to 2500 MHz	120 kHz	< 5 dBμV

5.2.5 Checking the Inherent Spurious Responses

Test setup: Terminate RF input of the ESPC with 50 Ω.

Settings on the ESPC:

RF ATT 0 dB
 Mode..... Low Distortion
 OP Range 60 dB

Define frequency scan with the settings given in the table below:

Start	Stop	Step	IF BW	Meas Time
100 kHz	5 MHz	1 kHz	10 kHz	10 ms
5 MHz	2500 MHz	10 kHz	120 kHz	1 ms

Setting of the level and frequency axes:

min level -10 dB
 max level 50 dB
 frequency axis LOG

Measurement: Start scan and plot or print the chart upon termination of scan.

The level indicated due to inherent spurious responses must not exceed the following values:

receiver frequency 100 kHz to 5 MHz..... 40 to 20 dBμV
 receiver frequency >30 MHz 20 dBμV

5.2.6 Measurement Errors

5.2.6.1 Level Measurement Error

The level measurement error of the ESPC is obtained from:

- the error of the internal calibration generator,
- the error of the RF attenuator,
- the nonlinearity of the demodulator and the log module
- the residual calibration error and
- the signal-to-noise ratio.

The total error is below ± 2 dB if the signal-to-noise ratio is sufficient.

Test utilities: Signal generator
 Power meter
 Pulse generator: - level 60 dB μ V/MHz ± 0.1 dB (with 100 MHz),
 - pulse frequency switchable (1 Hz to 1 kHz)
 - frequency response < ± 0.2 dB (9 kHz to 30 MHz)

The output level of the signal generator is calibrated to the rated value with each frequency set using the thermal power meter (error < 0.1 dB).

5.2.6.1.1 Frequency Response

a) Average Detector AV

Test setup: Connect signal generator to the RF input of the ESPC.
 Level 70 dB μ V ± 0.2 dB

Settings on the ESPC:
Mode Low Noise
Detector AV
OP Range 60 dB
IF BW 10 kHz
Detector AV

Measurement: Check the level measuring accuracy in the frequency range 9 kHz to 2500 MHz
 A calibration has to be performed prior to the measurement.
 Rated value displayed (digital) 70 dB μ V
 permitted error of the digital display:

Range	max. error
9 kHz to 1000 MHz	± 1 dB
1000 to 2500 MHz	± 1.5 dB

b) Peak Detector (Pk)

Test setup: Connect signal generator to RF input of the ESPC.
 Level..... 80 dB μ V ± 0.2 dB

Settings on the ESPC:
RF ATT 10 dB
Mode Low Noise
Detector Pk
OP Range 60 dB

IF BW 10 kHz
 Meas Time 100 ms

Measurement: Check the level measurement accuracy with 100 MHz. Perform a short calibration prior to the measurement.

Rated display (digital) 80 dB μ V
 permitted error of the digital display ± 1 dB

c) Quasi-Peak Detector (QP)

Error with pulses:

Test setup: Connect pulse generator to the RF input of the ESPC.

ESPC settings:

Mode Low Noise
 Detector QP
 Op. Range 60 dB
 Meas Time 500 ms

Measurement: Measure level on the ESPC

Frequency	Pulse frequency	Pulse level	RF attenuation	Display level in the range 0 to 60 dB	Rated level
100 kHz	25 Hz	114.6 dB μ V/MHz	10 dB	approx. 25 dB	35 dB μ V
1 MHz	100 Hz	80 dB μ V/MHz	0 dB	approx. 40 dB	33.1 dB μ V
100 MHz	100 Hz	60 dB μ V/MHz	0 dB	approx. 20 dB	30 dB μ V

Error with sinewave signals:

Test setup: Connect signal generator to the RF input of the ESPC.

Frequency 1 MHz
 Level 80 dB μ V ± 0.2 dB

ESPC settings:

Mode Low Noise
 Detector QP
 Op. Range 60 dB
 Meas Time 100 ms

Measurement: Measure level on the ESPC.

Rated level 80 dB μ V

Frequency	RF attenuation	Display level in the range from 0...60 dB	Tolerance
100 kHz	40 dB	approx. 60 dB	± 1.5 dB
1 MHz	20 dB	approx. 60 dB	± 1.5 dB
100 MHz	10 dB	approx. 60 dB	± 1.5 dB

Quasi-peak weighting curve:

Band A (only with option ESPC-B2 fitted):

Test setup: Connect pulse generator to the RF input of the ESPC.

ESPC settings:

Frequency 100 kHz
RF attenuation 10 dB
Mode Low Noise
Op. Range 60 dB
Meas Time 2 s

Measurement: Measure level on ESPC depending on the pulse frequency of the pulse generators according to the table below. The reference value is the level at a pulse frequency of 25 Hz.

Pulse frequency	Rated level	Rated value of weighting	Tolerance
25 Hz	35 dB μ V	- (Ref.)	± 1 dB
100 Hz	39 dB μ V	+4 dB	± 1 dB
60 Hz	38 dB μ V	+3 dB	± 1 dB
10 Hz	31 dB μ V	-4 dB	± 1 dB
5 Hz	27.5 dB μ V	-7.5 dB	± 1.5 dB
2 Hz	22 dB μ V	-13 dB	± 2.0 dB

Band B:

Test setup: Connect pulse generator to the RF input of the ESPC.

ESPC settings:

Frequency 5 MHz
RF attenuation 0 dB
Mode Low Distortion
Op. Range 60 dB
Meas Time 2 s

Measurement: Measure level on the ESPC depending on the pulse frequency of the pulse generator according to the table below. The reference value is the level at a pulse frequency of 100 Hz.

Pulse frequency	Rated level	Rated value of weighting	Tolerance
100 Hz	33 dB μ V	-----	± 0.5 dB
20 Hz	26.5 dB μ V	-6.5 dB	± 1 dB
10 Hz	23 dB μ V	-10 dB	± 1.5 dB
2 Hz	12.5 dB μ V	-20.5 dB	± 2.0 dB
1 Hz	10.5 dB μ V	-22.5 dB	± 2.0 dB

Band C/D:

Test setup: Connect pulse generator to the RF input of the ESPC
Level 80 dBµV/MHz

ESPC settings:
Frequency 100 MHz
Rf attenuation 0 dB
Mode Low Dist
Detector QP
Op Range 60 dB
Meas Time 2 s

Measurement: Measure level on the ESPC depending on the pulse frequency of the pulse generator. The level with a pulse frequency of 100 Hz is the reference level.

Pulse frequency	Rated level	Rate level of weighting	Tolerance
100 Hz	50.0 dBµV	—	±0.5 dB
20 Hz	41.0 dBµV	-9,0 dB	±1 dB
10 Hz	36 dBµV	-14.0 dB	±1.5 dB
2 Hz	24.0 dBµV	-26.0 dB	±2.0 dB
1 Hz	21.5 dBµV	-28.5 dB	±2.0 dB

5.2.6.1.2 Display Linearity

Test utilities: Signal generator
Attenuator, attenuation corrected
max. permitted error 0.1 dB

Test setup: Connect signal generator to the RF input of the ESPC via an attenuator.
Level of signal generator..... 83 dBµV
Residual attenuation of attenuator.....3 dB

a) 30-dB Range

ESPC settings:
Frequency 100 MHz
RF ATT 50 dB
Mode Low Noise
Detector AV
OP Range 30 dB
IF BW 10 kHz
Meas Time 100 ms

Measurement: >Set the level on the signal generator such that the ESPC indicates full reflection. (80.0 dBµV).
>Increase the attenuation of the attenuator in steps of 2 dB to 33 dB and measure indicated level with the respective setting. Simultaneously, check the analog level indication on the instrument.
The displayed level decreases by 2 dB with each attenuation step.
Permitted linearity error of the digital display ± 0.5 dB

b) 60-dB range:

ESPC settings:
Frequency 100 MHz
RF ATT 20 dB
Mode Low Noise
Detector AV
OP Range 60 dB
IF BW 10 kHz
Meas Time 100 ms

Measurement: deflection

- Set the level on the signal generator such that the ESPC indicates full deflection (80.0 dB μ V).
- Increase the attenuation of the attenuator from 3 to 63 dB in steps of 5dB and
- measure level with the respective settings. Simultaneously,
- check the analog level indication on the instrument.

The level indication decreases by 5 dB per attenuation step.
Permitted linearity error of the digital display \pm 0.5 dB

5.2.6.1.3 Error of the Attenuator

Test utilities: Signal generator
Attenuator, attenuation corrected
max. permitted error < 0.2 dB

Test setup: Connect signal generator to the RF input of the ESPC via an attenuator.
Level of the signal generator 120 dB μ V
Attenuation of the attenuator 70 dB

ESPC settings:
RF attenuation 10 dB
IF BW 10 kHz
Mode Low Dist
Detector AV
Op Range 60 dB
Meas Time 100 ms
Preamp OFF
Frequency 100 MHz and 2200 MHz

Measurement:

- Set the level on the signal generator such that the ESPC indicates 40.0 dB μ V. (approx. 120 dB μ V).
- Set the attenuator to 80 dB and the RF attenuation of the ESPC to 0 dB.
- Then, reduce the attenuation in steps of 10 dB to 10 dB.
- Simultaneously, increase the RF attenuation of the ESPC in steps of 10 dB.
- Measure level display with the respective settings.

Rated level: 40 dB μ V + RF attenuation set
permitted attenuation error \leq 0.4 dB

5.2.7 Testing the Outputs

5.2.7.1 AF OUTPUT

Test utilities: Signal generator
Oscilloscope

Test setup: Connect signal generator to the RF input of the ESPC.
Frequency 100 MHz, 30 %-AM-modulated, AF = 1 kHz
Level 80 dB μ V
Connect oscilloscope to the RF output of the ESPC via jack plug.

Settings on the ESPC:
Frequency 100 MHz
RF ATT 20 dB
Mode Low Noise
Detector AV
OP Range 60 dB
IF BW 10 kHz
Meas Time 100 ms

Measurement: Set voltage on the oscilloscope such that visible distortions just do not occur, using the volume control.
Voltage to be set > 2 V.

5.2.7.2 10.7 MHz OUTPUT

Test utilities: Signal generator
RF millivoltmeter (ac)

Test setup: Connect signal generator to the RF input of the ESPC,
Frequency 100 MHz
Level 80 dB μ V \pm 0.2 dB
Connect RF millivoltmeter to the 10.7-MHz output on the rear panel of the ESPC.

Settings on the ESPC:
Frequency 100 MHz
RF ATT 20 dB
OP Range 60 dB
Detektor AV
IF BW 10 kHz
Mode Low Noise

Measurement: Measure the output level (EMK) using the RF millivoltmeter.
Rated value:typ. 1000 mV

5.2.7.3 User Port

5.2.7.3.1 Analog Output

Test utilities: Signal generator
Digital voltmeter

Test setup: Connect signal generator to the RF input of the ESPC.

Frequency 100 MHz
Level 80 dB μ V \pm 0,2 dB.

Settings on the ESPC:

Frequency 100 MHz
RF ATT 20 dB
Mode Low Noise
IF BW 9 kHz
Preamp OFF
Transducer OFF

Measurement: \triangleright Connect digital voltmeter to the USER PORT between pin 24 (gnd) and pin 23 (recorder 1).

Voltage on DVM 3.75 V
permitted error 100 mV

\triangleright Set level on the signal generator to 20 dB μ V \pm 0.2 dB.

Voltage on DVM 0.75 V
permitted error..... 100 mV

5.2.8 Testing the Inputs

5.2.8.1 Checking the External Reference

Test utility: Signal generator

Test setup: Connect signal generator to the EXT REF IN connector.

Frequency 10 MHz
Level 5 dBm

Measurement: \triangleright Select the item EXT REF in the SETUP menu and switch ON.
 \triangleright Switch off level on the signal generator.
 \triangleright The message CHECK EXT REF is output on the ESPC.
 \triangleright Switch off the external reference again in the SETUP menu.

5.2.8.2 Checking the Internal Battery Input (Option ESPC-B1)

Test utilities: Power supply
Digital voltmeter

Test setup: Connect power supply to X31 (motherboard).

Voltage12.7 V

Measurement: \triangleright Switch on ESPC.
 \triangleright The receiver switches on.
 \triangleright Press BATTERY key on the front panel. The pointer deflection adapts to thick/thin indication on the battery field.
 \triangleright Reduce voltage until the ESPC switches off.
 \triangleright Switch-off voltage.....10.8 V \pm 0.2 V
 \triangleright The standby-LED on the front panel flashes.

5.2.8.3 Checking the External Battery Supply

Test utilities: Power supply
Digital voltmeter

Test setup: Connect power supply to the EXT-BATT input of the ESPC.
Voltage12 V

Measurement: > Switch on ESPC. The receiver switches on.
> Vary voltage between 11 and 33 volts.
The ESPC remains switched on.
> Reduce voltage on the power supply.
The ESPC switches off when the voltage is 11 V \pm 0.2 V

Note: *When increasing the supply voltage, an instrument reset may occur with approx. 15.5 V and with approx. 14.5 V when decreasing the voltage.*

5.2.8.4 Checking the Antenna Code Socket

Test utility: Digital voltmeter

Test setup: Settings on the ESPC:
RF ATT 10 dB
IF BW 10 kHz
Mode..... Low Distortion
Detector AV

Measurement: > Connect X3/C to X3/A.
The unit in the level display changes from dB μ V to dB μ V/m.
> Connect X3/D to X3/A verbinden.
The unit in the level display changes from dB μ V to dB μ A.
> Connect X3/E to X3/A.
The zero scale deflection on the level display changes from 0 to 10 dB.
> Connect X3/F to X3/A.
The zero scale deflection changes from 0 to 20 dB.
> Connect X3/G to X3/A.
The zero scale deflection changes from 0 to 40 dB.
> Connect X3/H to X3/A.
The zero scale deflection changes from 0 to 80 dB.
> Connect X3/E and X3/M to X3/A.
The zero scale deflection changes from 0 to -10 dB.

5.3 Performance Test Report

Item No.	Characteristic	Measurement according to Section	Min.-value	Actual value	Max. value	Unit
1	Frequency error	5.2.1	10.699968	_____	10.700032	MHz
2	Input VSWR RF ATT: 0 dB	5.2.2				
	100 kHz		9.5	_____	-	dB
	1 MHz		9.5	_____	-	dB
	3 MHz		9.5	_____	-	dB
	7 MHz		9.5	_____	-	dB
	10 MHz		9.5	_____	-	dB
	21 MHz		9.5	_____	-	dB
	30 MHz		9.5	_____	-	dB
	70 MHz		9.5	_____	-	dB
	100 MHz		9.5	_____	-	dB
	180 MHz		9.5	_____	-	dB
	250 MHz		9.5	_____	-	dB
	450 MHz		9.5	_____	-	dB
	600 MHz		9.5	_____	-	dB
	950 MHz		9.5	_____	-	dB
	1200 MHz		9.5	_____	-	dB
	1800 MHz		9.5	_____	-	dB
	2100 MHz		9.5	_____	-	dB
	2400 MHz		9.5	_____	-	dB
3	Input VSWR RF ATT: 10 dB	5.2.2.1				
	100 kHz		15.6	_____	-	dB
	1 MHz		15.6	_____	-	dB
	3 MHz		15.6	_____	-	dB
	7 MHz		15.6	_____	-	dB
	10 MHz		15.6	_____	-	dB
	21 MHz		15.6	_____	-	dB
	30 MHz		15.6	_____	-	dB
	70 MHz		15.6	_____	-	dB
	100 MHz		15.6	_____	-	dB
	180 MHz		15.6	_____	-	dB
	250 MHz		15.6	_____	-	dB
	450 MHz		15.6	_____	-	dB
	600 MHz		11.7	_____	-	dB
	950 MHz		11.7	_____	-	dB
	1200 MHz		11.7	_____	-	dB
	1800 MHz		11.7	_____	-	dB
	2100 MHz			_____	-	
	2400 MHz			_____	-	

Item No.	Characteristic	Measurement according to Section	Min. value	Actual value	Max. value	Unit
4	Oscillator reradiation 9 kHz to 1900 MHz 1900 to 2500 MHz	5.2.2.2	- -	<u> </u> <u> </u>	50 60	dB μ V dB μ V
5	Interference rejection Image 1st IF 9 kHz to 1000 MHz 1000 to 1900 MHz	5.2.2.3.1	- -	<u> </u> <u> </u>	30 50	dB μ V dB μ V
		5.2.2.3.2	-	<u> </u>	60	dB μ V
	1900 to 2500 MHz Image 2nd IF $f_E = 100$ MHz		-	<u> </u>	30	dB μ V
	$f_E = 2490$ MHz		5.2.2.3.4	-	<u> </u>	30
	IF rejection 9 kHz to 2500 MHz		-	<u> </u>		dB μ V
6	3rd-order intercept 5/6 MHz 14/15 MHz 35/45 MHz 140/150 MHz 285/295 MHz 475/485 MHz 600/610 MHz 730/740 MHz 980/990 MHz 1120/1130 MHz 1500/1510 MHz 1870/1880 MHz 2030/2040 MHz 2470/2480 MHz	5.2.2.4.1	3	<u> </u>	-	dBm
			3	<u> </u>	-	dBm
			3	<u> </u>	-	dBm
			3	<u> </u>	-	dBm
			3	<u> </u>	-	dBm
			3	<u> </u>	-	dBm
			3	<u> </u>	-	dBm
			3	<u> </u>	-	dBm
			3	<u> </u>	-	dBm
			0	<u> </u>	-	dBm
			0	<u> </u>	-	dBm
			0	<u> </u>	-	dBm
			0	<u> </u>	-	dBm
			0	<u> </u>	-	dBm
7	2nd-order intercept 160 kHz 4 MHz 12 MHz 40 MHz 85 MHz 195 MHz 495 MHz 950 MHz 1250 MHz	5.2.2.4.2	25	<u> </u>	-	dBm
			25	<u> </u>	-	dBm
			25	<u> </u>	-	dBm
			25	<u> </u>	-	dBm
			25	<u> </u>	-	dBm
			25	<u> </u>	-	dBm
			25	<u> </u>	-	dBm
			25	<u> </u>	-	dBm

Item No.	Characteristic	Measurement acc. to Section	Min. value	Actual value	Max. value	Unit
11	Measurement error Detector: Pk 100 MHz	5.2.6.1.1 b	89	_____	91	dB μ V
12	Measurement error Detector: QP 100 kHz	5.2.6.1.1 c	33	_____	37	dB μ V
	1 MHz		31.1	_____	35.1	dB μ V
	100 MHz		28	_____	32	dB μ V
	Detector: QP 100 kHz	5.2.6.1.1 c	88.5	_____	91.5	dB μ V
	1 MHz		88.5	_____	91.5	dB μ V
	100 MHz		88.5	_____	91.5	dB μ V
	Frequency: 100 kHz Pulse frequency:	5.2.6.1.1 c	25 Hz	_____	35	dB μ V
	100 Hz		38	_____	40	dB μ V
	60 Hz		37	_____	39	dB μ V
	10 Hz		30	_____	32	dB μ V
	5 Hz		26	_____	29	dB μ V
	2 Hz		20	_____	24	dB μ V
	Frequency: 1 MHz Pulse frequency:		5.2.6.1.1 c	100 Hz	_____	33.0
	1000 Hz	36.5		_____	38.5	dB μ V
	20 Hz	25.5		_____	27.5	dB μ V
	10 Hz	21.5		_____	24.5	dB μ V
	2 Hz	10.5		_____	14.5	dB μ V
	1 Hz	8.5		_____	12.5	dB μ V
	Single pulse	7.5		_____	11.5	dB μ V
	Frequency: 100 MHz Pulse frequency:	5.2.6.1.1 c		100 Hz	_____	50.0
	1000 Hz		57.0	_____	59.0	dB μ V
	20 Hz		40.0	_____	42.0	dB μ V
	10 Hz		34.5	_____	37.5	dB μ V
2 Hz	21.5		_____	25.5	dB μ V	
1 Hz	19.5		_____	23.5	dB μ V	
Single pulse	16.5		_____	20.5	dB μ V	

Item No.	Characteristic	Measurement acc. to Section	Min. value	Actual value	Max. value	Unit
13	Linearity of digital display, IF BW: 10 kHz 30-dB range Attenuation: 3 dB 5 dB 7 dB 9 dB 11 dB 13 dB 15 dB 17 dB 19 dB 21 dB 23 dB 25 dB 27 dB 29 dB 31 dB 33 dB	5.2.6.1.2 a		80.0		
			77.5	_____	78.5	dB μ V
			75.5	_____	76.5	dB μ V
			73.5	_____	74.5	dB μ V
			71.5	_____	72.5	dB μ V
			69.5	_____	70.5	dB μ V
			67.5	_____	68.5	dB μ V
			65.5	_____	66.5	dB μ V
			63.5	_____	64.5	dB μ V
			61.5	_____	62.5	dB μ V
			59.5	_____	60.5	dB μ V
			57.5	_____	58.5	dB μ V
			55.5	_____	56.5	dB μ V
			53.5	_____	54.5	dB μ V
49.5	_____	50.5	dB μ V			
14	Linearity of digital display, IF BW: 10 kHz 60-dB range Attenuation: 3 dB 8 dB 13 dB 18 dB 23 dB 28 dB 33 dB 38 dB 43 dB 48 dB 53 dB 58 dB 63 dB	5.2.6.1.2 b		80.0		
			74.5	_____	75.5	dB μ V
			69.5	_____	70.5	dB μ V
			64.5	_____	65.5	dB μ V
			59.5	_____	60.5	dB μ V
			54.5	_____	55.5	dB μ V
			49.5	_____	50.5	dB μ V
			44.5	_____	45.5	dB μ V
			39.5	_____	40.5	dB μ V
			34.5	_____	35.5	dB μ V
			29.5	_____	30.5	dB μ V
			24.5	_____	25.5	dB μ V
			19.5	_____	20.5	dB μ V

Item No.	Characteristic	Measurement acc. to Section	Min. value	Actual value	Max. value	Unit
15	Error of the attenuator Frequency: 100 MHz Attenuation: 0 dB 10 dB 20 dB 30 dB 40 dB 50 dB 60 dB 70 dB Frequency: 2200 MHz Attenuation: 0 dB 10 dB 20 dB 30 dB 40 dB 50 dB 60 dB 70 dB	5.2.6.1.3				
			-	40.0	-	dB μ V
			49.3	_____	50.7	dB μ V
			59.3	_____	60.7	dB μ V
			69.3	_____	70.7	dB μ V
			79.3	_____	80.7	dB μ V
			89.3	_____	90.7	dB μ V
			99.3	_____	100.7	dB μ V
			10.3	_____	110.7	dB μ V
			16	AF output	5.2.7.1	1,5
17	10.7-MHz output	5.2.7.2	800	_____	1200	mV
18	User port recorder 1	5.2.7.3.1	3.65	_____	3.85	V
			0.65	_____	0.85	V

